

Geuder®

MILESTONES OF MODERN
OPHTHALMIC SURGERY

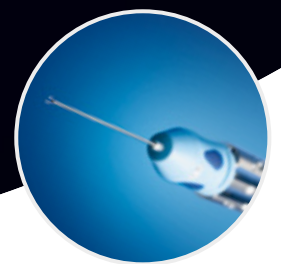

70
YEARS
1951 - 2021



Geuder®
Precision made in Germany

INSTRUMENTS

MAIN CATALOGUE

10 / 2021

FOCUSED ON PRECISION.

GEUDER - PRECISION MADE IN GERMANY.

GEUDER AG was founded by Hans Geuder Sr. in Heidelberg 1951, since then it has become a worldwide leading manufacturer of ophthalmic surgical instruments and systems as well as provider for highly purified biomaterials. The broad portfolio offered by GEUDER AG includes a wide range of surgical equipment for the anterior and posterior segments of the eye, along with highly innovative biomaterials for retinal and cataract surgery developed and produced by our affiliated company FLUORON GmbH.

As a result of intensive contact and cooperations with leading experts in the ophthalmology world, GEUDER AG is continuously developing and

manufacturing the most innovative products that fulfill the international standards.

A numerous amount of granted patents in more than 70 years demonstrates our intensive involvement in research and development, as well as our forward-looking philosophy. Always keeping our goal to provide the highest level of precision and reliability while complying with the requirements of ophthalmologists to serve the patient's expectations and well being.

With over 3.000 ophthalmic surgical products being distributed in more than 100 countries, GEUDER AG covers a large range of instruments



required for surgical procedures in the anterior and posterior segment of the eye. Thanks to innovative production technologies our instruments offer a unique level of precision and longevity. The constant extension of our product range – particularly single-use instruments – is following the current and especially prospective regulatory requirements and statutory regulations in the medical sector.

Qualified and specialized employees in the field of service and repair ensure that the product's performance and quality is maintained over years – an important feature for the ophthalmic surgeon who is aware of quality and environment.

Our catalogue, in addition to classic standard instruments also displays the most representative current instruments as well as novelties and new developments for innovative surgical methods.

Please contact us for more detailed information about our surgical instruments, systems and biomaterials.

Certified to ISO 13485, 9001 and others



	EYE SPECULA	01
	RETRACTORS	02
CALIPERS · MARKERS · MEASURING INSTRUMENTS · TONOMETER · OCULOPRESSOR		03
	CURETTES · SPOONS	04
	FOREIGN BODY INSTRUMENTS	05
	KNIVES · DIAMOND KNIVES	06
	TREPHINES	07
	GLAUCOMA PUNCHES · RONGEURS	08
	SCISSORS	09
	FORCEPS	10
	NEEDLE HOLDERS	11
MANIPULATORS · CHOPPERS · FIXATION RINGS · HOOKS · SPATULAS · LENS LOOPS		12
	SCLERAL DEPRESSORS · LOCALIZERS	13
	PROBES · DILATORS	14
	CANNULAS · I/A INSTRUMENTS	15
	SINGLE USE INSTRUMENTS	16
	MISCELLANEOUS	17
	STERILIZATION CONTAINERS AND ADAPTERS	18
	SETS	19
	INDEX	20

01.	EYE SPECULA	13
	Wire	15 – 17
	Wire · Adjustable	18 – 19
	Adjustable · Locking	20 – 26
	Aspiration · Adjustable · Locking	27 – 30
	Glaucoma · Adjustable	31
	Glaucoma · Adjustable · Aspiration	32
02.	RETRACTORS	33
	Lid	35
	Lacrimal Sac	37
03.	CALIPERS · MARKERS · MEASURING INSTRUMENTS	
	TONOMETER · OCULOPRESSOR	39
	Corneal Markers	41 – 43
	Calipers	43
	Rulers · Trabeculectomy Markers	44
	Strabismus Markers · LASIK Markers	45
	Keratometer · Degree Gauges · Axis Markers	46
	Toric Markers	47
	Tonometer · Oculopressor	48
04.	CURETTES · SPOONS	49
	Chalazion	51 – 52
	Enucleation	52
05.	FOREIGN BODY INSTRUMENTS	53
	Foreign Body Spuds · Needles · Gouges	55 – 56
06.	KNIVES · DIAMOND KNIVES	57
	Diamond Knives: Paracentesis · Sideport · Universal	59
	Diamond Knives: Tri-Facet · Clear Cornea · Trapezoid · Phaco	60
	Diamond Knives: Clear Cornea · Crescent · Step Knife · LRI	61
	Diamond Knives: Micrometers · Viscocanalostomy · Retinal Surgery	62
	Keratome · Chalazion · Viscocanalostomy · Scleral	63
	Corneal Scarifier · DMEK Scraper	64
	SATO	65
	Micro · CRVO	66
07.	TREPHINES	69
	Trephines	69 – 70
	Punch	70
	Silicone Blocks	71

08.	GLAUCOMA PUNCHES · RONGEURS	73
	Rongeurs.....	75
	Glaucoma Punches.....	76–77
09.	SCISSORS	79
	Corneal · Corneal Section.....	81–82
	Stitch.....	82
	Synechia · Trabeculum · Capsulotomy.....	83
	Capsulotomy · Capsule.....	84
	Capsulotomy · Rotatable · Interchangeable.....	85
	Capsule (interchangeable and rotatable) · Iris.....	86
	Iris.....	87–88
	IOL.....	87–88
	Scissors with Needle Holder.....	88
	Tenotomy · Conjunctival · Ring Handle.....	89
	Tenotomy · Strabismus · Ring Handle.....	90
	Utility · Ring Handle.....	91
	Utility · Stitch · Ring Handle.....	92
	Utility · Probe Tips · Ring Handle.....	93
	Utility · Enucleation · Ring Handle.....	94
	Vitreoretinal 20 Gauge.....	95
	Vitreoretinal 23 and 25 Gauge.....	96
	Vitreoretinal (Interchangeable and Rotatable).....	97
10.	FORCEPS	99
	Cilia · Foreign Body.....	101
	Conjunctiva.....	102
	Suturing · Fixation.....	103
	Suturing · Colibri Style.....	104
	Corneal Fixation.....	104–105
	<i>PAUFIQUE</i> Suturing/Tying.....	105
	Tying.....	106–108
	Iris suture · Fragment.....	108
	Jewelers · Fixation.....	109
	Dressing · Tissue · Iris Fixation.....	110
	Iris Fixation.....	111–112
	Capsulorhexis.....	113–114
	Capsulorhexis · Micro incision.....	115
	Capsulorhexis · Micro Incision · Interchangeable.....	116
	Capsulorhexis · DMEK · Descemetorhexis.....	117
	DSAEK.....	118
	LASIK Flap.....	118–119
	Lenticule Extraction.....	119

Nucleus Cracker	120
Nucleus Prechoppers	120 – 122
IOL Implantation	121
IOL Implantation · Silicone Coated	122
IOL Implantation · Iris Claw · IOL folders	123
IOL Folders	124
IOL Holders	124
IOL Explantation	125
Superior Rectus	126
Muscle	126 – 127
Nasal · Retinal	127
Vitreoretinal (Holding) · Scleral Plugs	128
Vitreoretinal (Spreading, Trocar, Foreign Body, Magnet)	129
Vitreoretinal 20 Gauge	130 – 131
Vitreoretinal 23 and 25 Gauge	132
Vitreoretinal · Interchangeable · Rotatable	133
Chalazion · Ptosis	134
Mosquito · Hemostat	135
Towel Clamps · Serrefines	136
11. NEEDLE HOLDERS	137
Needle Holders	139 – 144
Needle Holder with Scissors · Intraocular 25 Gauge	143
Blade Holders	145
12. MANIPULATORS · CHOPPERS · FIXATION RINGS	
HOOKS · SPATULAS · LENS LOOPS	147
Fixation Rings	149 – 150
Nucleus Choppers	151 – 154
Fixation Ring	151
Manipulators	153 – 155
Nucleus Choppers	154 – 155
IOL Manipulators	156 – 157
Position Hooks	156 – 157
Iris Hooks	157 – 158
Nucleus Fragmentation Spatulas	158
Phaco Spatulas	159
Capsule Polishers	160
Lens Loops	161 – 162
Orbital Spatulas	163
Keratoplasty · Synechia Spatulas	164
Cyclodialysis Spatulas	165

	Iris Spatulas	166 – 167
	Enucleation	168
	LASIK Spatulas.....	168 – 169
	DMEK Hooks · DSAEK Glide	169
	Femtosecond Cataract.....	170
	Femtosecond LASIK.....	170 – 172
	Suture Hook	173
	Strabismus Muscle Tucker	173
	Femto-LASIK.....	173
	Strabismus Hooks	174 – 175
	Membrane Spatulas.....	176
	Membrane Peelers.....	176
	Micro Hook	177
13.	SCLERAL DEPRESSORS · LOCALIZERS	179
	Scleral Depressors.....	181 – 182
	Localizers.....	182
	Fixation Ring.....	182
14.	PROBES · DILATORS	183
	Lacrimal Probes	185 – 188
	Corneal Implant Probes	186
	Trabecular Probes · U-Shaped Probe.....	188
15.	CANNULAS · I/A INSTRUMENTS	189
	Lacrimal.....	191 – 192
	Lacrimal Probes	192
	Retrobulbar · Eye Douche · A.C. Maintainers · Cystotome · Enzyme	193
	Hydrodissection · Cyclodialysis.....	194
	Irrigation Vectis · Healon · Trabeculotomy · Sub-Tenon	195
	Irrigation	196
	Irrigation/Aspiration.....	196 – 197
	Capsule Polishers.....	197 – 198
	LASIK	198 – 199
	Irrigation Cannula Handpieces.....	199
	I/A Handpieces · Bimanual	200
	Bimanual Irrigation/Aspiration.....	201 – 203
	Irrigation Choppers · Irrigation Hook · Irrigation Scraper	204
	DMEK Irrigation.....	205
	Coaxial Irrigation/Aspiration.....	205 – 207
	Retinal · Backflush Handpieces.....	208
	Retinal · Backflush Cannulas	209

	Retinal · Backflush Tips	210
	Retinal · Infusion/Injection Cannulas	211
	Retinal · Infusion · Aspiration · PFCL.....	212
	Retinal.....	213
	Miscellaneous.....	214
16.	SINGLE USE INSTRUMENTS.....	215
	Manual Trephines · Cutting Block · Non-Vacuum Punches.....	217
	Vacuum Trephines and Punches.....	218
	Surgical Knives	219 – 220
	Scissors.....	221
	Forceps.....	222
	Endo Probes	223 – 224
	Trocars.....	225
	Fiber Optics	225 – 226
	Vitreous Cutters · Infusion Tube.....	226
	DMEK Cartridge · Iris Retractors · Lacrimal Intubation	227
	Intubation Sets · Cannulas (Lacrimal, Retrobulbar, Cystotome, A.C. Maintainer).....	228
	Cannulas (A.C. Maintainer, Rycroft, Hydrodissection, Unfolding).....	229
	Cannulas (Irrigation Vectis, Capsule Polisher, Simcoe, Viscocanalostomy, Irrigation)	230
	Bimanual I/A Handpiece · Backflush Handpiece · Backflush Cannula · Silicone Brush	231
	Cannulas (Backflush with Silicone Tip, PFCL, Silicone Oil, Infusion).....	232
	Cannulas (Injection, Viscous Fluids, Gas)	233
	Injection Syringes · Filter · Stopcock · Injection Tube.....	234
	Oil Injection	235
	Battery Cautery · Scalpel Handle · Absorbent Swabs · Marking Pen.....	236
	Silicone Tires.....	237
	Silicone Strips	238 – 239
	Silicone Circling Bands.....	238
	Silicone Sleeves.....	239 – 240
	Silicone Sponge Implants.....	240 – 242
	Bonn Injection Set (IVOM).....	243
17.	MISCELLANEOUS	245
	Injectors (for <i>MORCHER</i> Capsular Tension Ring and Pupil Dilators)	247
	Lacrimal Instruments · Rongeur · Nasal Speculum · Hammer · Elevatorium · Raspatorium	248
	Bone Chisels · LASEK Funnel · Fascia Needle	249
	Diamond Burr · Vitrectomy Lenses	250
	Eye Shield · Battery Cautery · Intraocular Magnet.....	251
	Diathermy Instruments	252

18.	STERILIZATION CONTAINERS AND ADAPTERS.....	253
	MICROSTOP®	255 – 257
	Filters for Steel Cases.....	257
	Trays and Racks for Steel Cases.....	258
	Silicone Strips · Silicone Mats · Seals	259
	Small Cases	260
	STERISAFE® DURO	261 – 265
	Rinsing Adapter and Tubing.....	265
	Cleaning Adapters.....	266 – 268
19.	SETS	269
	ECCE – Extra Capsular Cataract Extraction.....	272
	Phaco / Cataract.....	273
	Phaco Emergency · MSICS – Manual Small Incision Cataract Surgery.....	274
	MICS – Micro Incision Cataract Surgery · FLACS – Femtosecond Laser-assisted Cataract Surgery	275
	IOL Explantation · Toric IOL · IOL Scleral Fixation.....	276
	Iris Suture	276
	LASEK · LASIK.....	277
	Femto LASIK · ReLEx SMILE.....	278
	Keratoplasty	279
	DSEK / DSAEK · DALK.....	280
	DMEK.....	281
	Glaucoma.....	282
	Emergency	283
	Enucleation · Pterygium	284
	Office Set (Optometrist) · Chalazion.....	285
	Lid / Ptosis	286
	DCR / LACRIMAL	287
	Strabismus / Muscle.....	288
	Retinal Detachment.....	289
	Vitrectomy 20G	290 – 291
	Vitrectomy 23G	292 – 293
	Vitrectomy 25G	294
20.	INDEX	295
	Numerical Index.....	296 – 303
	Keyword Index	304 – 312
	Name Index.....	313 – 315
	APPENDIX	316
	Customer Service / Repair	316 – 317
	Devices.....	318 – 321
	FLUORON® Liquids and Gases.....	322 – 323

© GEUDER AG

Although every effort has been made to ensure the accuracy of the content presented in this catalogue, GEUDER AG cannot be held liable for any errors that may occur.

Due to the constant technological progress all product specifications and illustrations are subject to change without notice.

No part of this catalogue may be reproduced, edited, copied or disseminated in any form (analog or digital) without prior written consent of GEUDER AG.

All rights reserved by GEUDER AG, Heidelberg, Germany.
Any violation of the copyright will be prosecuted.

Edition 10/2021

© GEUDER AG

Manufacturer of ophthalmic surgical instruments and systems

Some Geuder products may not be available for sale in certain countries where the products have not yet received investigational, clinical or marketing approval. Please contact your local distributor or GEUDER AG for more information.

GEUDER AG
Hertzstr. 4
69126 Heidelberg
Germany

Phone: +49 6221 306-6
Fax: +49 6221 303122
info@geuder.de
www.geuder.de

„NanOEdge®“, „UNO Colorline®“, „Densiron®“, „Megatron®“, „endoTRON®“ and „MACH2“ are registered trademarks of Geuder AG.

„EasyGas®“ is a registered trademark of Fluoron GmbH.

„Sterisafe®“ is a registered trademark of SAVUNA GmbH & Co. KG.

„microStop®“ is a registered trademark of Gebrüder Martin GmbH & Co. KG.

„ReLex® Smile“ and „SMILE“ are registered trademarks of Carl Zeiss Meditec AG.

„IRIDEX®“ is a registered trademark of IRIDEX Corporation.

„ACCURUS®“ is a registered trademark of Alcon Laboratories, Inc.

„Pentasy®“ is a registered trademark of Fritz RUCK Ophthalmologische Systeme GmbH.

„Millennium®“ is a registered trademark of MBI Millennium Biomedical, Inc.

„Emerald“ is a registered trademark of Becton, Dickinson and Company (BD)

„KIRWAN“ is a registered trademark of Kirwan Surgical Products LLC

EYE SPECULA

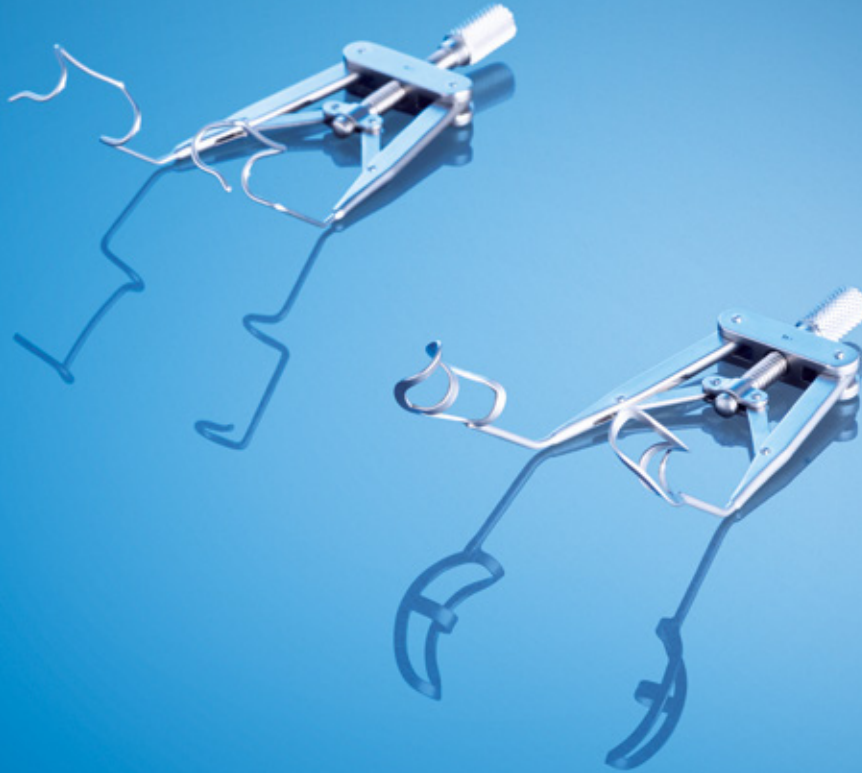

WIRE	15
WIRE AND ADJUSTABLE	18
ADJUSTABLE · LOCKING	20
WITH ASPIRATION	27
ADJUSTABLE ADJUSTABLE · BLADE ELEVATION	31

G-17020 *BARRAQUER*
EYE SPECULUM
fenestrated
14 mm blades
overall length 38 mm



01

WIRE

G-17025 *BARRAQUER*
EYE SPECULUM
for infants
fenestrated
10 mm blades
overall length 40 mm



G-17023 *BARRAQUER*
EYE SPECULUM
for premature infants
fenestrated
7 mm blades
overall length 34 mm

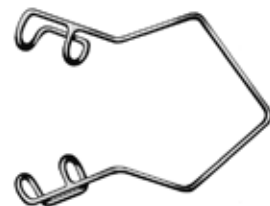

G-17026 *BARRAQUER*
EYE SPECULUM
15 mm solid blades
overall length 40 mm



01

WIRE

G-32136 *BARRAQUER*
EYE SPECULUM
 fenestrated
 14 mm round blades
 overall length 38 mm

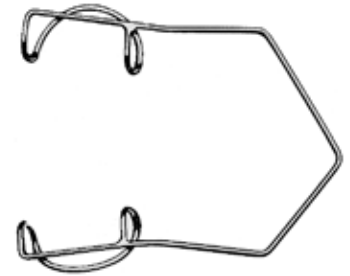

G-32137 *BARRAQUER*
EYE SPECULUM
 for infants
 fenestrated
 10 mm round blades
 overall length 38 mm

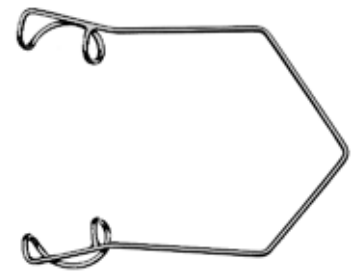

G-32148 *BARRAQUER*
EYE SPECULUM
 fenestrated
 14.5 mm open blades
 overall length 40 mm



G-32149 *BARRAQUER FRANKFURT MODEL*
EYE SPECULUM
 fenestrated, large
 14.5 mm blades
 overall length 40 mm

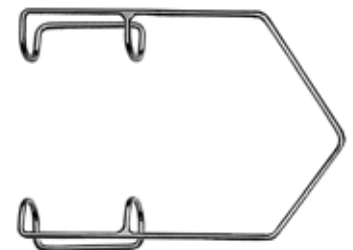

G-32133*KRATZ-BARRAQUER***EYE SPECULUM**

fenestrated
15 mm round wing blades
overall length 40 mm

to lift and retract the lids away from the globe
eliminating external pressure



01

WIRE

*OHNO***EYE SPECULUM**

fenestrated
14 mm round blades
overall length 45 mm
middle bar controls redundant lid tissue
for the right eye
for the left eye

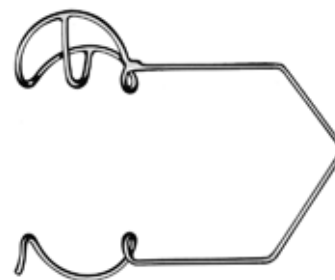
G-32126**G-32127****G-17004***H.-R. KOCH***TEMPORAL APPROACH EYE SPECULUM**

for nasal placement
fenestrated
14 mm open blades
overall length 40 mm

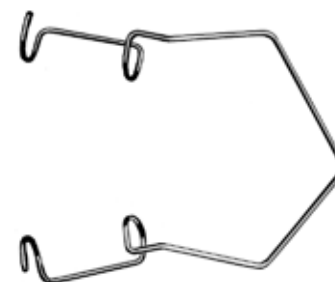
**G-32129****TEMPORAL APPROACH EYE SPECULUM**

for nasal placement
fenestrated
15 mm round blades
overall length 40 mm



01

WIRE · ADJUSTABLE

BARRAQUER-OOSTERHUIS

EYE SPECULUM

fenestrated, adjustable

G-17010

14 mm blades, overall length 40 mm

G-17011

10 mm blades, overall length 30 mm, for infants

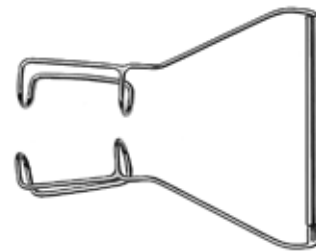

BARRAQUER-OOSTERHUIS

EYE SPECULUM

solid blades, adjustable

G-17015

15 mm blades, overall length 40 mm

G-17016

11 mm blades, overall length 30 mm, for infants



BARRAQUER-OOSTERHUIS

EYE SPECULUM

fenestrated round blades

adjustable

G-32138

14 mm blades, overall length 40 mm

G-32139

11 mm blades, overall length 30 mm, for infants

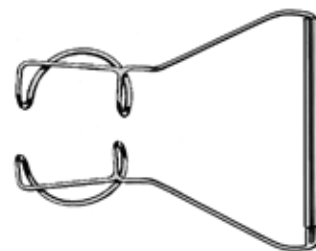

G-17017

BARRAQUER-OOSTERHUIS-KRATZ

EYE SPECULUM

adjustable, fenestrated

15 mm open blades

overall length 40 mm

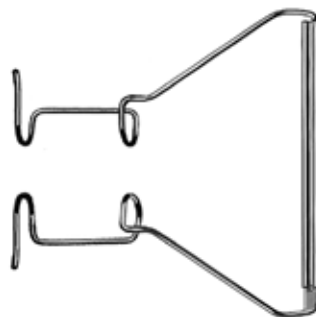

- G-32119** *KRATZ-BARRAQUER*
EYE SPECULUM
adjustable, fenestrated
15 mm round wing blades
overall length 40 mm



01

WIRE · ADJUSTABLE

- G-17027** *THOMAS NEUHANN*
EYE SPECULUM
adjustable
15 mm solid blades
overall length 40 mm



- G-17030** *SAUER*
EYE SPECULUM
12 mm solid blades
overall length 30 mm



- G-32134** *TAKEDA*
EYE SPECULUM
for infants
9 mm fenestrated blades
with finger grips and
angled interlacing valves
overall length 28 mm

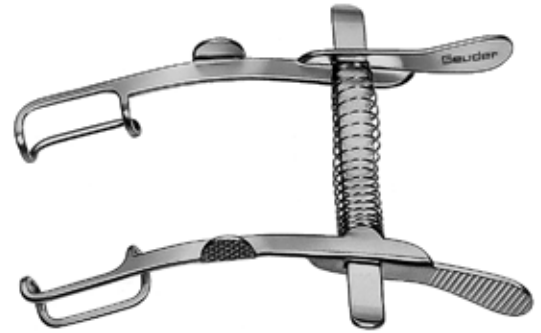

G-15945

MELLINGER
EYE SPECULUMlarge
adjustable, self retaining
16.5 mm fenestrated blades
overall length 65 mm

G-32130

MELLINGER
EYE SPECULUMsmall, for infants
adjustable, self retaining
12.5 mm fenestrated blades
overall length 55 mm

G-15946

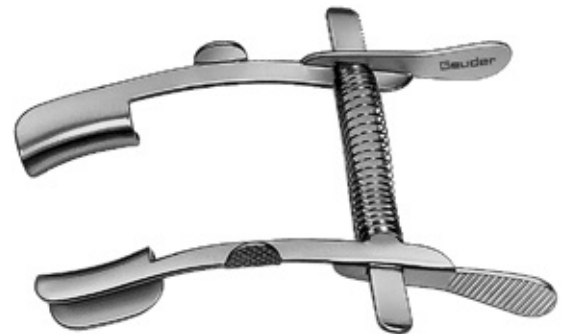
MELLINGER-BEARD
EYE SPECULUMlarge
adjustable, self retaining
15.5 mm solid blades
overall length 65 mm

G-32135

MELLINGER-BEARD
EYE SPECULUMsmall, for infants
adjustable, self retaining
11.5 mm solid blades
overall length 55 mm

*PRETORI***EYE SPECULUM**

13.5 mm fenestrated blades
adjustable, self retaining
overall length 63 mm
left
right

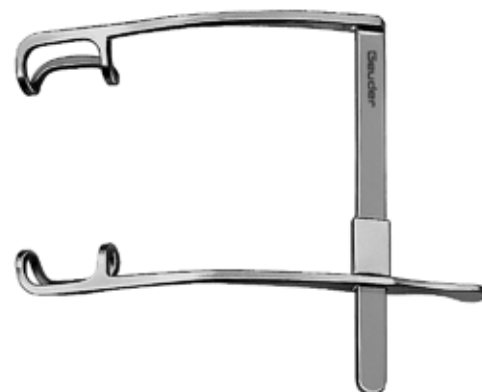
G-16050**G-16055****G-15950***WEISS***EYE SPECULUM**

fenestrated
adjustable with locking screw
17.5 mm blades
overall length 85 mm

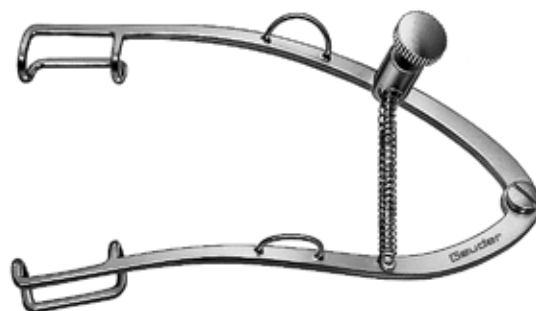
**G-15951***WEISS***EYE SPECULUM**

fenestrated
adjustable with locking screw
17.5 mm open blades
overall length 85 mm

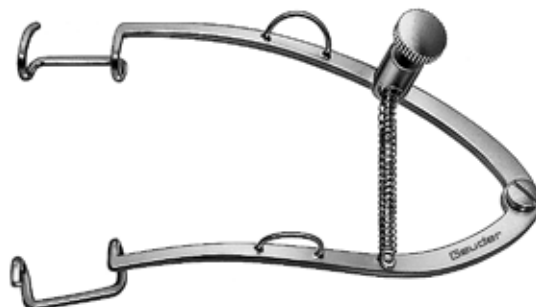
**G-15955***WEISS***EYE SPECULUM**

small
adjustable with locking screw
15 mm fenestrated blades
overall length 55 mm



G-15956

WEISS
EYE SPECULUM

small
adjustable with locking screw
15 mm open blades
overall length 55 mm



G-15970

WEISS
EYE SPECULUM

adjustable with locking screw
16.5 mm solid blades
overall length 85 mm



G-15975

WEISS
EYE SPECULUM

small
adjustable with locking screw
14 mm solid blades
overall length 55 mm



- G-16010** *BANGERTER*
EYE SPECULUM
adjustable, with locking screw
15 mm solid blades
overall length 52 mm

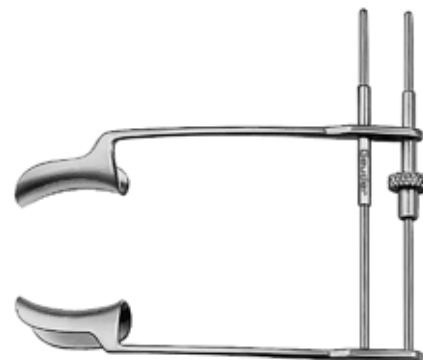

- CASTROVIEJO*
EYE SPECULUM
fenestrated, adjustable
overall length 96 mm
G-16020 14 mm blades, small
G-16025 16 mm blades, medium
G-16030 18 mm blades, large



- G-15990** *COOK*
EYE SPECULUM
large
16 mm solid blades
adjustable, with locking screw
overall length 50 mm



- G-15995** *COOK*
EYE SPECULUM
medium
11 mm solid blades
adjustable, with locking screw
overall length 40 mm



01

ADJUSTABLE · LOCKING

01

ADJUSTABLE · LOCKING

G-16000

COOK
EYE SPECULUM

small
8 mm solid blades
adjustable, with locking screw
overall length 35 mm



G-32128

COOK
EYE SPECULUM

for infants
5 mm solid blades
adjustable, with locking screw
overall length 30 mm



G-17000

MURDOCK
EYE SPECULUM

left
14 mm fenestrated blades
adjustable, self retaining
overall length 50 mm



G-17001

MURDOCK
EYE SPECULUM

right
14 mm fenestrated blades
adjustable, self retaining
overall length 50 mm

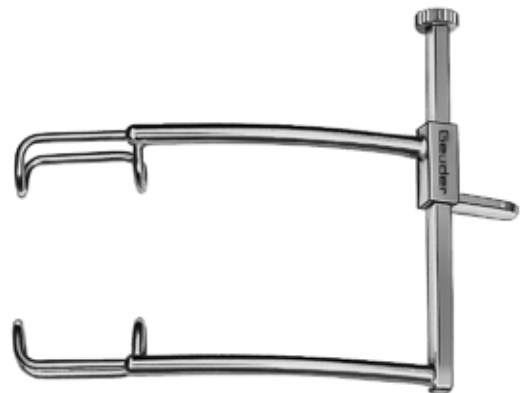

MURDOCK
EYE SPECULUM

small
12 mm fenestrated blades
adjustable, self retaining
overall length 45 mm
left
right

G-17002
G-17003

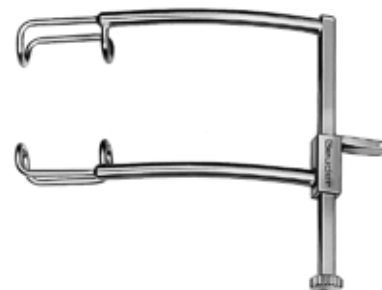

01

ADJUSTABLE · LOCKING

G-15960*LIEBERMAN-TENNANT*
EYE SPECULUM

adjustable, fenestrated
for temporal placement
15 mm open blades
overall length 80 mm

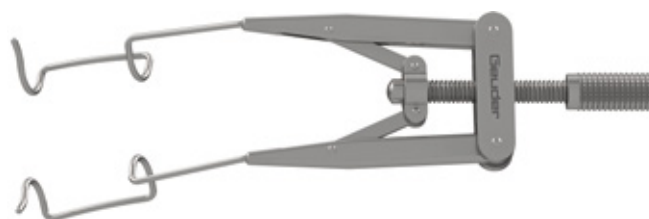
**G-15965***KERSHNER*
EYE SPECULUM

adjustable, reversible
for nasal and temporal placement
15 mm fenestrated blades
overall length 75 mm

**G-15966***KERSHNER*
EYE SPECULUM

adjustable, reversible
for nasal and temporal placement
15 mm solid blades
overall length 75 mm



G-33965

DICK
FEMTOCATARACT EYE SPECULUM

adjustable
18 mm flattened fenestrated blades with middle bar to control redundant lid tissue
overall length 80 mm

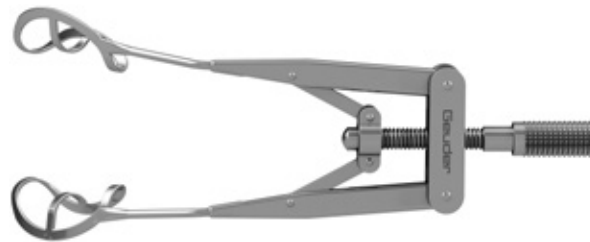

G-33971

SOLOMON
FEMTOCATARACT EYE SPECULUM

14.5 mm flattened fenestrated blades with middle bar to control redundant lid tissue
double knurled screw for fast adjustment and fine tuning
overall length 90 mm



G-33919

SPARE TUBING SET
for eye speculum with aspiration

scale 1:2

G-33920

KNORZ
LASIK EYE SPECULUM

adjustable, with aspiration
16 mm fenestrated blades
to remove excess fluid from the surgical field
supplied with silicone tubing and adaptor

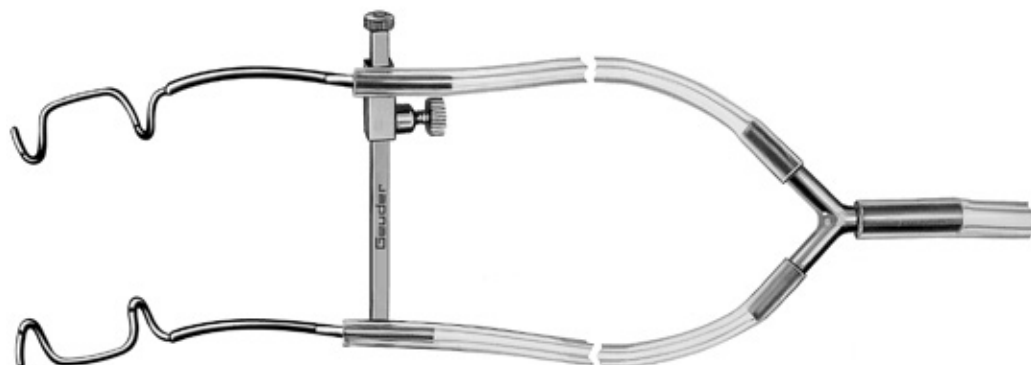

*NODA***EYE SPECULUM**

adjustable, with aspiration
to remove excess fluid from the surgical field
supplied with silicone tubing and adaptor

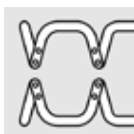
**G-17019**

15 mm open blades

G-17021

12 mm open blades, for infants

**G-17005***PAULMANN***EYE SPECULUM**

adjustable, with aspiration
for PPV, with extra aspiration bar
16 mm fenestrated blades
to remove excess fluid from the surgical field
supplied with silicone tubing and adaptor

G-17006**CLAMP FOR INFUSION TUBE**for *PAULMANN* eye speculum (G-17005)

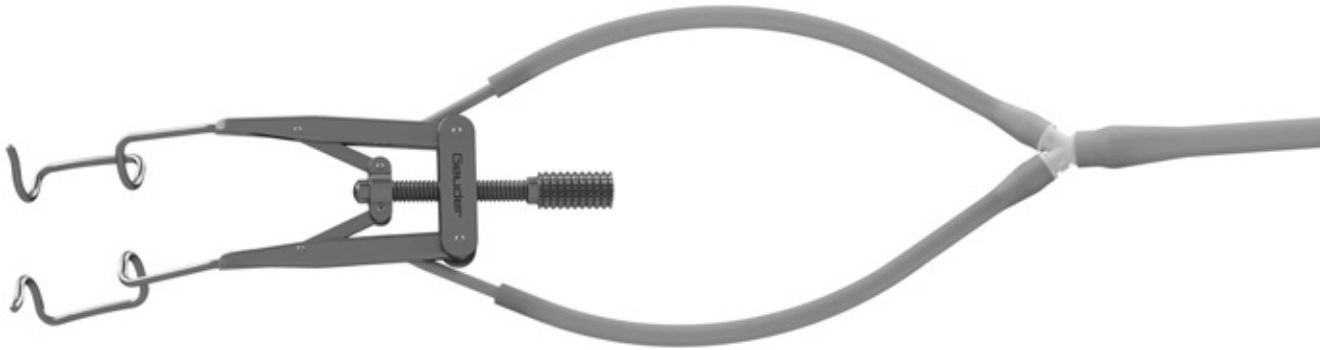

G-15961

LIEBERMAN-TENNANT
EYE SPECULUM

adjustable, with aspiration
for temporal placement
15 mm open blades
overall length 80 mm
to remove excess fluid from the surgical field
supplied with silicone tubing and adaptor

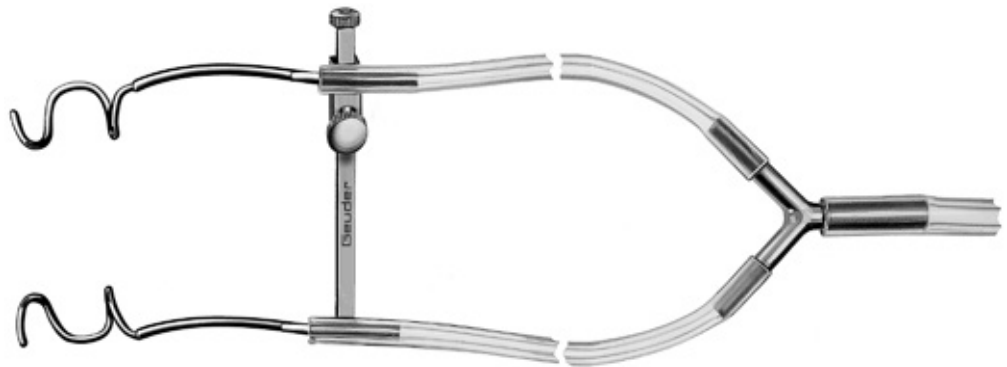
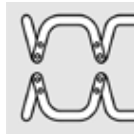

G-17024

KOGA / NODA
EYE SPECULUM

with 5 mm aspiration slits
adjustable
12 mm open blades
to remove excess fluid from the surgical field
supplied with silicone tubing and adaptor



G-17031

NODA

EYE SPECULUM

adjustable, with aspiration
open blades
2 x 10 aspiration ports
supplied with silicone tubing and adaptor

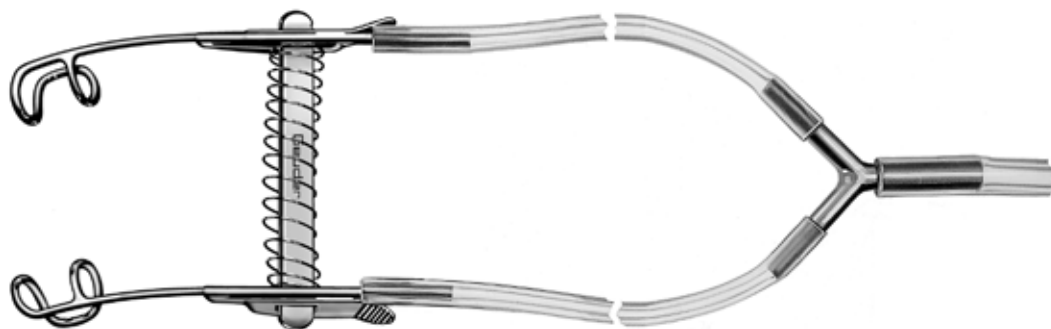
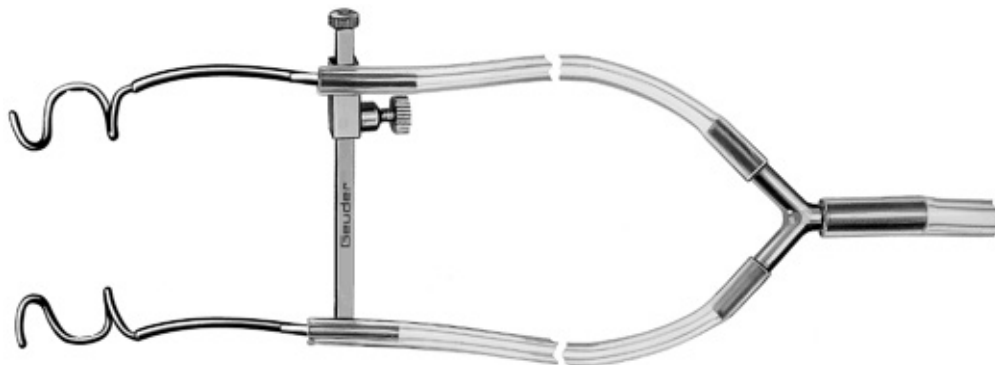

G-15962

KAMMANN

EYE SPECULUM

adjustable, with aspiration
self retaining
11 mm fenestrated blades
to remove excess fluid from the surgical field
supplied with silicone tubing and adaptor

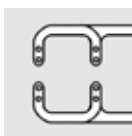

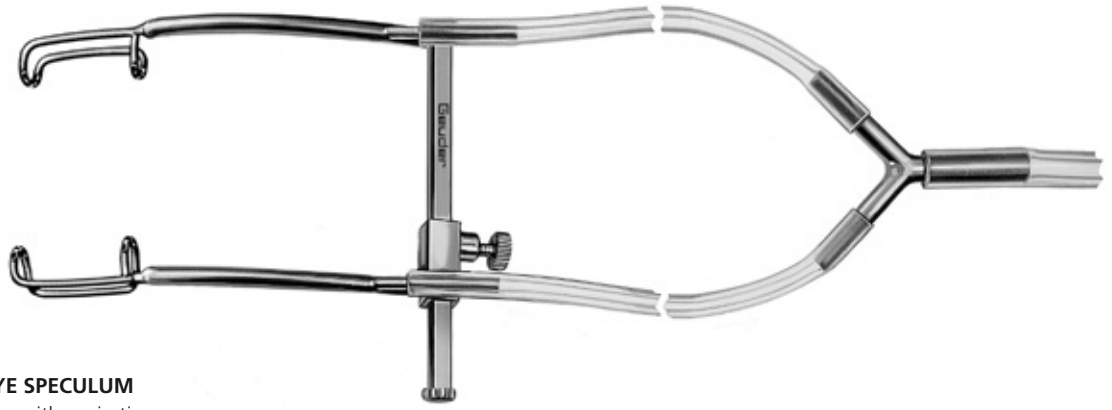

G-33914

ZIRM

LASIK EYE SPECULUM

adjustable, with aspiration
 16 mm fenestrated blades
 to remove excess fluid from the surgical field
 supplied with silicone tubing and adaptor

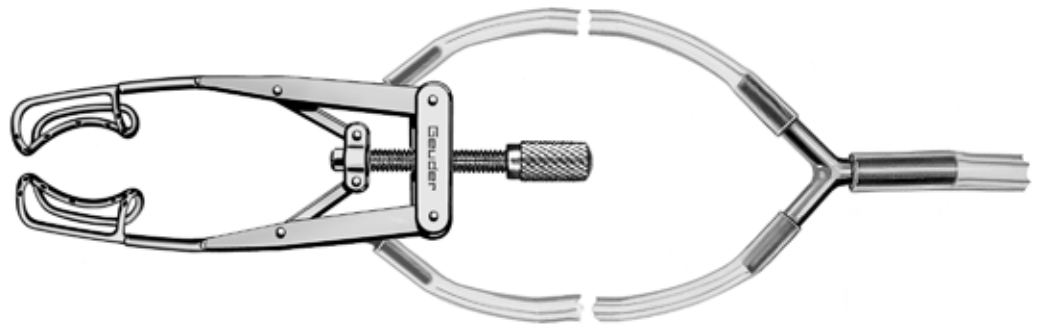

G-33925

MAUS

LASIK EYE SPECULUM

adjustable, with middle aspiration bar
 16 mm fenestrated blades
 to remove excess fluid from the surgical field
 supplied with silicone tubing and adaptor

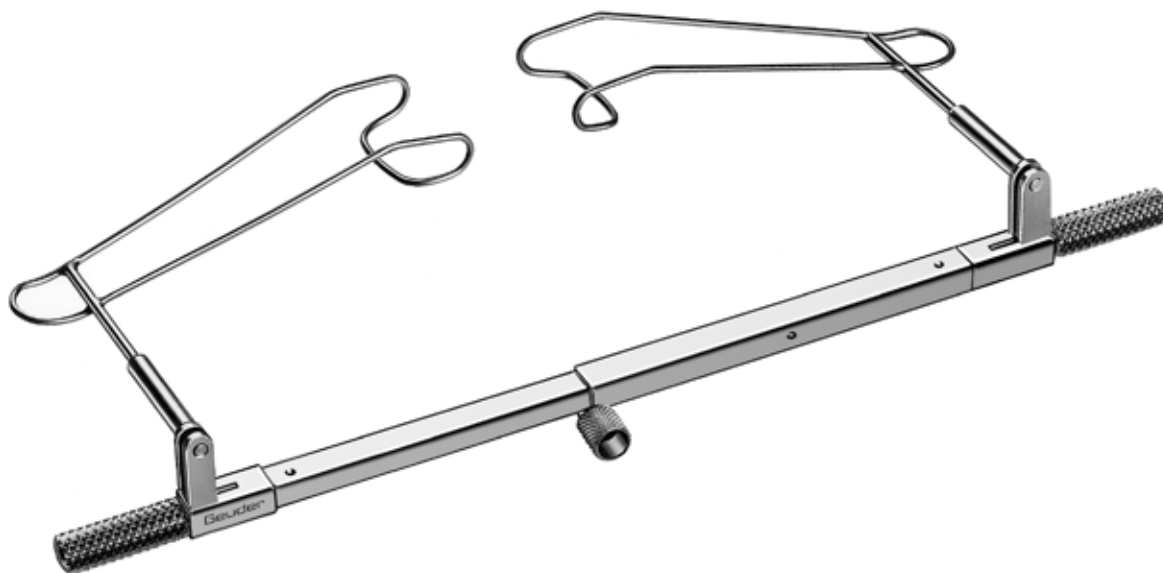
**EYE SPECULUM**

fenestrated blades
adjustable mechanism regulates opening and blade elevation
optimal for glaucoma surgery

G-15920

large, 16 mm blades

G-15925

small, 12 mm blades

*SCHOTT***EYE SPECULUM**

solid blades
adjustable mechanism regulates opening and blade elevation
optimal for glaucoma surgery

G-15921

large, 15 mm blades

G-15926

small, 11 mm blades

01

GLAUCOMA · ADJUSTABLE · ASPIRATION

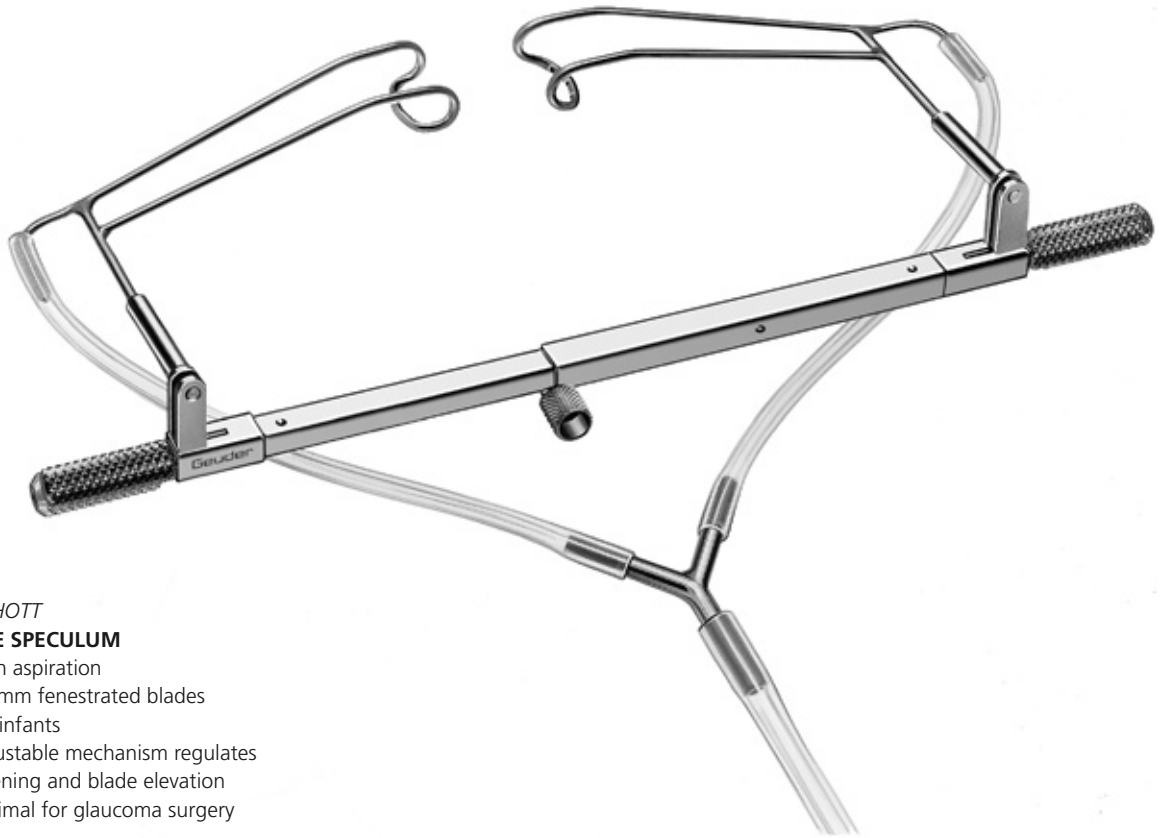

G-15928

SCHOTT
EYE SPECULUM

with aspiration
13 mm fenestrated blades
for infants
adjustable mechanism regulates
opening and blade elevation
optimal for glaucoma surgery

RETRACTORS





G-16080 *DESMARRES*
LID RETRACTOR
for infants
7 mm wide
overall length 133 mm



G-32120 *DESMARRES*
LID RETRACTOR
fig. 0
9 mm wide
overall length 138 mm



G-16060 *DESMARRES*
LID RETRACTOR
fig. 1
12 mm wide
overall length 133 mm



G-16065 *DESMARRES*
LID RETRACTOR
fig. 2
14 mm wide
overall length 135 mm



G-16070 *DESMARRES*
LID RETRACTOR
 fig. 3
 16 mm wide
 overall length 138 mm



G-16075 *DESMARRES*
LID RETRACTOR
 fig. 4
 17 mm wide
 overall length 138 mm



G-32115 *GIESSEN MODEL*
LID RETRACTOR
 14 mm wide, fenestrated
 overall length 133 mm



G-17040 *JAEGER*
LID PLATE
 stainless steel
 20 mm and 23 mm concave ends
 overall length 110 mm



G-15542 *AXENFELD*
LACRIMAL SAC RETRACTOR
4 prongs, blunt
9 mm wide
overall length 140 mm



AXENFELD
LACRIMAL SAC RETRACTOR
3 prongs, 7 mm wide
overall length 140 mm
G-15540 blunt
G-15545 sharp



AXENFELD
LACRIMAL SAC RETRACTOR
2 prongs, 4 mm wide
overall length 140 mm
G-15550 blunt
G-15555 sharp



G-15560 *ROLLET*
LACRIMAL SAC RETRACTOR
4 prongs, sharp
6 mm wide
overall length 140 mm



GUTHRIE
RETRACTOR
 double skin hook, sharp
 overall length 125 mm
G-15350 small
G-15355 large



G-17085 *AMERICAN MODEL*
LACRIMAL SAC RETRACTOR
 4 x 4 prongs, blunt
 cross-action
 adjustable, self retaining
 overall length 100 mm



G-17070 *MUELLER*
LACRIMAL SAC RETRACTOR
 3 x 3 prongs
 adjustable
 overall length 70 mm



G-17080 *GOLDSTEIN*
LACRIMAL SAC RETRACTOR
 3 x 3 prongs
 adjustable
 overall length 30 mm

CALIPERS, MARKERS MEASURING INSTRUMENTS TONOMETER, OCULOPRESSOR



CORNEAL MARKERS.....	41
CALIPERS · RULERS.....	43
RULERS · TRABECULECTOMY MARKER.....	44
STRABISMUS MARKERS · LASIK MARKERS.....	45
KERATOMETER · DEGREE GAUGES · AXIS MARKERS.....	46
TORIC MARKERS.....	47
TONOMETER · OCULOPRESSOR.....	48



THOMAS NEUHANN
CORNEAL MARKER
with cross hairs
inside diameter 3.0 mm
outside diameter 12.0 mm
overall length 105 mm



- G-33725** 4 blades
- G-33726** 6 blades
- G-33727** 8 blades



- G-32222** *THOMAS NEUHANN*
CORNEAL MARKER
for astigmatic keratotomy
10° scale and cross-hairs
6.0 mm inside diameter
8.0 mm outside diameter
overall length 105 mm

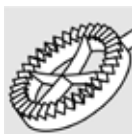

HOFFER
CORNEAL MARKER
for optic zone
with cross hairs
overall length 103 mm



- G-33730** inside diameter 3.0 mm
- G-33732** inside diameter 3.5 mm
- G-33733** inside diameter 3.75 mm
- G-33734** inside diameter 4.0 mm
- G-33735** inside diameter 4.5 mm
- G-33736** inside diameter 5.0 mm
- G-33737** inside diameter 5.5 mm
- G-33738** inside diameter 6.0 mm
- G-33739** inside diameter 6.5 mm
- G-33740** inside diameter 7.0 mm
- G-33741** inside diameter 7.5 mm
- G-33742** inside diameter 8.0 mm

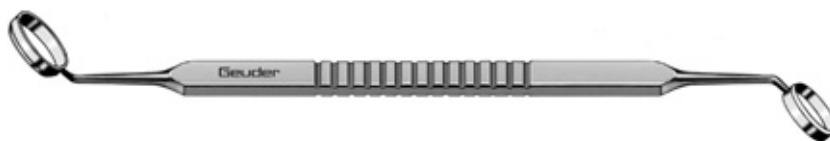

G-38600

THOMAS NEUHANN

CORNEAL MARKER

for DSAEK/DSEK/DMEK procedures
combination of 8.0 mm / 9.0 mm diameters
to produce a guide for Descemetorhexis
overall length 123 mm



LINDSTROM

CORNEAL MARKER

to mark arcuate incisions
for surgical correction of astigmatism
overall length 100 mm

G-33780

optic zone 6.0 mm

G-33781

optic zone 7.0 mm



DUNCKER

SUTURE MARKER

8-pointed star and cross hairs
to center the trephine and perform
double running suture
overall length 102 mm

G-32228

for 7.0 mm transplant

G-32229

for 8.0 mm transplant



G-32224

THOMAS NEUHANN

SUTURE MARKER

8 blades
for keratoplasty
fits with *KRUMEICH* GTS
overall length 102 mm



SUFFO / HOMBURG MODEL

CORNEA SUTURE MARKER

for penetrating keratoplasty (PK)
to fix the corneal graft by a Hoffmann
double running crossed diagonal suture
with 2 x 8 bites



G-33743

for 7.5 mm grafts

G-33744

for 8.0 mm grafts

CASTROVIEJO

CALIPER

scale on both sides
with 1 mm increments

G-19130

15 mm scale, overall length 78 mm

G-19135

20 mm scale, overall length 85 mm



G-19138

OSHER

INCISION MEASURING CALIPER

1 to 10 mm

scale on both sides

for internal measurement of cataract incisions

overall length 75 mm



G-37400

BRAUNSTEIN

FIXED CALIPER

for marking of sclerotomy site

at 3.5 mm posterior to the surgical limbus

overall length 45 mm



BRAUNSTEIN

FIXED CALIPER

for marking of sclerotomy site posterior

to the surgical limbus

overall length 80 mm

G-37410

3.0 mm / 3.5 mm

G-37412

3.0 mm / 4.0 mm

G-37414

3.5 mm / 4.0 mm

G-37418

4.0 mm / 5.0 mm





G-18650 **RULER**
150 mm
0.5 mm and 1.0 mm increments

G-18645 *GIESSEN MODEL*
RULER
vaulted
1 to 30 mm
overall length 60 mm



G-32225 *VOGT*
SCLERAL RULER
vaulted
1 to 20 mm
overall length 126 mm



G-32004 *ENGELS*
MEASURING SPATULA
1 to 15 mm
angled 45°
overall length 88 mm



G-32210 *FRONIMOPOULUS*
TRABECULECTOMY MARKER
5 x 5 mm
U-shaped marking pattern
overall length 70 mm



G-32209 *TOBIAS NEUHANN*
SCLERAL FLAP MARKER
5.0 mm and 4.0 mm
U-shaped marking patterns
swivel handle allows marking from temporal
or superior approach



G-15797

FINK

STRABISMUS MARKER

1 mm criss-cross marking tips
for accurate 9 mm recession of the
inferior oblique muscle
overall length 87 mm



G-33785

GRENE

VISUAL AXIS MARKER

0.5 mm diameter
concave tip
overall length 103 mm



G-33745

MENDEZ

LASIK CORNEAL MARKER

for lamellar flap identification
and realignment
overall length 105 mm

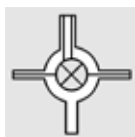
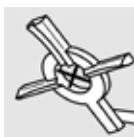

G-33746

CHAYET

LASIK CORNEAL MARKER

for lamellar flap identification
and realignment
overall length 105 mm



G-33747

LU

LASIK CORNEAL MARKER

for lamellar flap identification
and realignment
overall length 105 mm

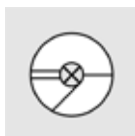

03

STRABISMUS MARKERS · LASIK MARKERS

G-32318

MALONEY
KERATOMETER

for qualitative measurement of astigmatism
overall length 20 mm



G-33760

MENDEZ
DEGREE GAUGE

measures from 0° to 180°
5° increments
12 mm inside diameter
overall length 110 mm



G-33762

DEGREE GAUGE

for toric IOLs
with 5° increments and
rotating alignment rings
12 mm inside diameter
overall length 110 mm



G-33763

GERTEN
HORIZONTAL AXIS MARKER

for precise marking of the 0° axis
during toric IOL implantation
or refractive laser surgery
overall length 105 mm



G-33774

SCOTT
CORNEAL PENDULUM MARKER

for temporary placement of
0°, 90°, and 180° pre-op toric marks
self-leveling pendulum assures precise
horizontal axis
overall length 110 mm



03

KERATOMETER · DEGREE GAUGES · AXIS MARKERS

G-33777

**TOMARK
ADJUSTABLE CORNEAL MARKER**

to mark the axis of astigmatism during toric IOL placement
0° to 180° degree gauge
5° increments
overall length 32 mm



for use in combination with slit lamp or G-33776

03

TORIC MARKERS



G-33776

TOMARK PENDULUM INSTRUMENT

self-leveling handheld pendulum assures precise
horizontal axis
overall length 140 mm

to retain TOMARK corneal marker G-33777

G-33778

RETAINER FOR PENDULUM INSTRUMENT

for G-33776 TOMARK
overall length 180 mm

scale 1:2





G-19230 *SCHIOETZ*
TONOMETER
with two weights of 7.5 g and 10 g

G-15392 *HOMBURG MODEL*
OCULOPRESSOR

G-15393 **SILICONE BALL**
with band, for Oculopressor
HOMBURG MODEL G-15392



CURETTES SPOONS





G-15900 *MEYHOEFER*
CHALAZION CURETTE
1.0 mm diameter cup
overall length 129 mm



G-15870 *MEYHOEFER*
CHALAZION CURETTE
2.0 mm diameter cup
overall length 129 mm



G-15875 *MEYHOEFER*
CHALAZION CURETTE
2.5 mm diameter cup
overall length 129 mm



G-15880 *MEYHOEFER*
CHALAZION CURETTE
3.0 mm diameter cup
overall length 129 mm



G-15885 *MEYHOEFER*
CHALAZION CURETTE
4.0 mm diameter cup
overall length 129 mm

04

CHALAZION



G-15840 *HEBRA*
CHALAZION CURETTE
 small
 2.5 mm x 4.0 mm oval scoop
 overall length 133 mm



G-15910 *AXENFELD*
CHALAZION CURETTE
 double ended
 4.5 x 2.5 mm and 6.5 x 3.0 mm oval currettes
 overall length 144 mm



G-31545 *BUNGE*
EXENTERATION CURETTE
 medium
 10 mm spoon
 overall length 142 mm



G-31555 *BUNGE*
EXENTERATION CURETTE
 large
 12 mm spoon
 overall length 144 mm

04

CHALAZION · ENUCLEATION

FOREIGN BODY INSTRUMENTS

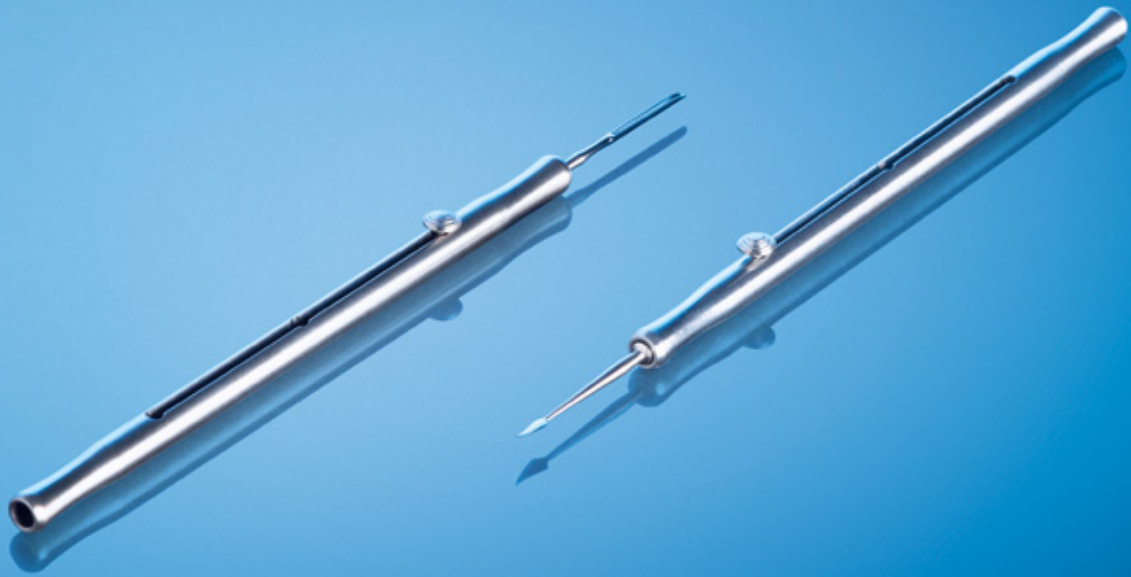



G-14550 **FOREIGN BODY INSTRUMENT**
double-ended with sliding handle
2.2 mm wide curved needle
1 mm wide *PLANGE* spud
overall length 95 mm



G-14540 **FOREIGN BODY INSTRUMENT**
double ended with sliding handle
2.2 mm wide curved needle
1.4 mm wide gouge
overall length 95 mm



G-14530 **FOREIGN BODY INSTRUMENT**
double ended with sliding handle
2.2 mm wide curved needle
1.4 mm wide spud
overall length 95 mm

G-14490

FOREIGN BODY NEEDLE

straight
4.5 mm long triangular tip
2.4 mm wide
overall length 120 mm



G-14500

FOREIGN BODY NEEDLE

curved
4.5 mm long triangular tip
2.4 mm wide
overall length 120 mm



G-14570

PLANGE
FOREIGN BODY SPUD

curved and rounded
1 mm wide spud
overall length 125 mm



G-14480

FOREIGN BODY GOUGE

straight
1.4 mm wide gouge
overall length 116 mm



KNIVES DIAMOND KNIVES



PARACENTESIS · SIDEPORT · UNIVERSAL	59
TRIFACET · CLEAR CORNEA	60
CRESCENT · STEP TRIFACET · LRI	61
MICROMETER · VISCOCANALOSTOMY · RETINAL SURGERY	62
KERATOME · CHALAZION · SCLERAL	63
CORNEAL SCARIFIER · DMEK SCRAPER	64
SATO	65
MICRO · CRVO	66



G-38475 **DIACLEAN DIAMOND KNIFE**
for paracentesis
1 mm wide spear
titanium handle
width 1.0 mm
length 4.0 mm
thickness 0.2 mm

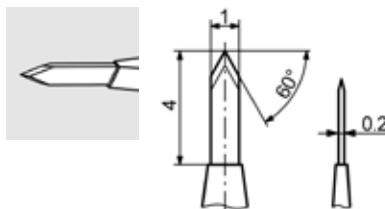

G-38344 **DIACLEAN DIAMOND KNIFE**
1 mm wide, 45° diamond blade
titanium handle
width 1.0 mm
length 3.0 mm
thickness 0.2 mm

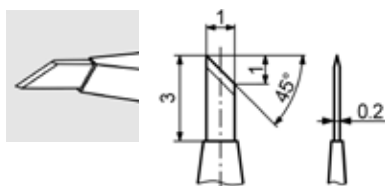

G-38341 **DIACLEAN DIAMOND KNIFE**
60° spear diamond blade
titanium handle
width 1.4 mm
length 3.0 mm
thickness 0.2 mm

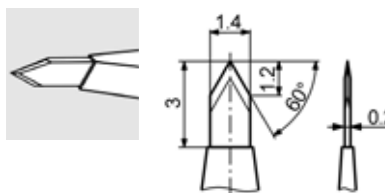

G-38343 **DIACLEAN DIAMOND KNIFE**
45° spear diamond blade
titanium handle
width 1.4 mm
length 3.0 mm
thickness 0.2 mm

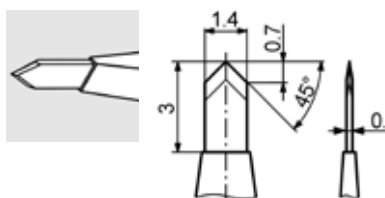



G-38342 DIACLEAN TRI-FACET DIAMOND KNIFE

1 mm wide tri-facet diamond blade
titanium handle
width 1.0 mm
length 3.0 mm
thickness 0.2 mm

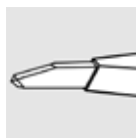
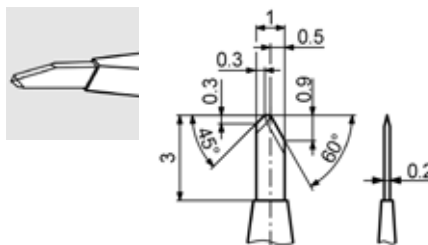

06



G-38473 PHAM DIACLEAN TRI-FACET DIAMOND KNIFE

titanium handle
width 1.5 mm
length 3.0 mm
thickness 0.2 mm

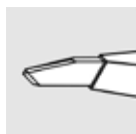
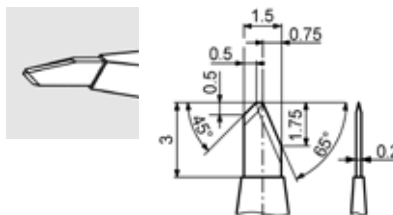

DIAMOND KNIVES: TRI-FACET · CLEAR CORNEA · TRAPEZOID · PHACO



G-38448 DIACLEAN CLEAR-CORNEA-INCISION DIAMOND KNIFE, 1.5/2.0 mm

MICS trapezoid blade, 35° angled
4 cutting edges
titanium handle
width 1.5 / 2.0 mm
length 5.0 mm
thickness 0.2 mm

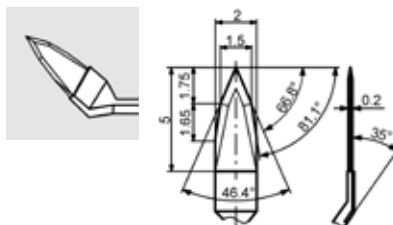

G-38444 DIACLEAN CLEAR-CORNEA-INCISION DIAMOND KNIFE, 2.2 MM

4 cutting edges, 35° angled
titanium handle
width 2.2 mm
length 5.0 mm
thickness 0.2 mm

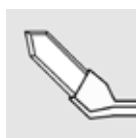
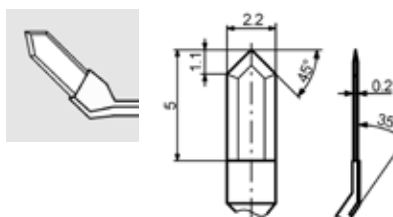



**G-38453 DIACLEAN CLEAR-CORNEA-INCISION
DIAMOND KNIFE, 2.85 MM**

4 cutting edges, 35° angled
titanium handle
width 2.85 mm
length 5.0 mm
thickness 0.2 mm

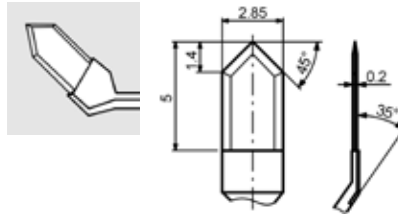

**G-38466 DIACLEAN DIAMOND
CRESCENT KNIFE, 2.0 MM**

round spatula shape, 40° angled
titanium handle
width 2.0 mm
length 4.0 mm
thickness 0.2 mm

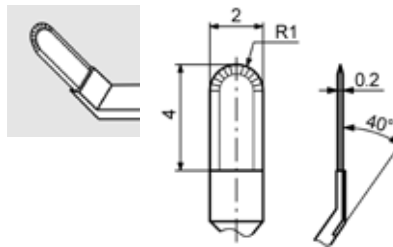

G-31470 TRI-FACET DIAMOND STEP KNIFE

single footplate, titanium handle
stepwise adjustable
in sterilizing case
width 1.0 mm
length 3.0 mm
thickness 0.2 mm

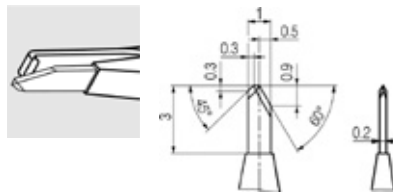

**G-31468 LIMBAL RELAXING INCISION
DIAMOND KNIFE**

LRI knife with 0.6 mm precalibrated depth
single footplate, titanium handle
width 1.0 mm
length 3.0 mm
thickness 0.2 mm

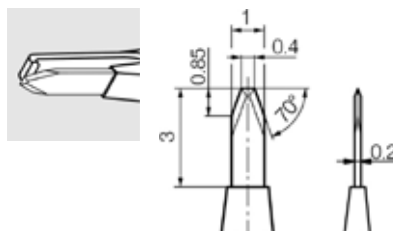

G-31480

DIAMOND MICROMETER KNIFE

tri-facet for keratotomy
vertical and 15° cutting edges with
0.2 mm flat base cutting edge
double footplate, titanium handle
width 0.6 mm
length 3.0 mm
thickness 0.1 mm

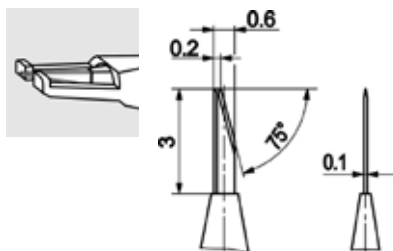

G-19345

DIAMOND MICROMETER KNIFE

for keratotomy
single 45° cutting edge
double footplate, titanium handle
width 1.0 mm
length 3.0 mm
thickness 0.2 mm

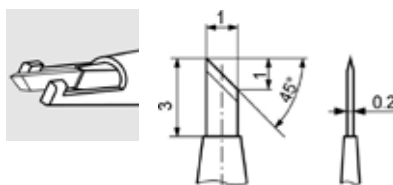

G-31487

DIAMOND KNIFE

for viscocanalostomy
0.5 mm wide, 70° diamond blade
width 0.5 mm
length 4.0 mm
thickness 0.2 mm

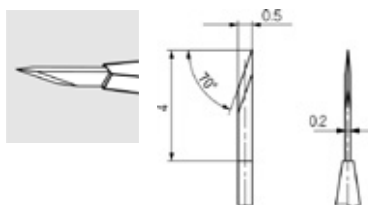

G-31477

RETINA DIAMOND KNIFE

45° cutting edge
20 gauge / 0.9 mm
titanium handle
width 0.9 mm
length 3.0 mm
thickness 0.2 mm

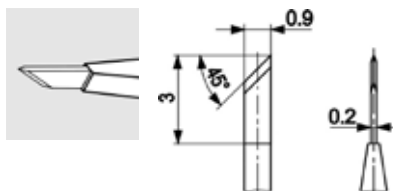



G-14420 *HAMBURG MODEL*
KERATOME
angled at 14 mm from tip
10 mm cutting surface
1.1 mm wide
overall length 120 mm



G-14000 **CHALAZION KNIFE**
straight, delicate
10 mm cutting surface
1.8 mm wide
overall length 120 mm



G-14105 **MICRO ROUND KNIFE**
for viscocanalostomy
0.8 mm diameter disc-shaped blade
overall length 112 mm



G-14180 *BONN MODEL*
SCLERAL KNIFE
7 mm blade, rounded tip
overall length 126 mm



G-14185 *BONN MODEL*
SCLERAL KNIFE
4 mm blade, rounded tip
overall length 126 mm



KUHNT
CORNEAL SCARIFIER

rounded tip
overall length 123 mm
fig. 1, 5.5 mm x 2.5 mm blade
fig. 2, 4.5 mm x 2.0 mm blade

G-14010
G-14020



G-38621

SZURMAN
DMEK PREPARATION SCRAPER
4.0 mm lower blade, blunt
1.5 mm rounded tip, sharp
for removal of Descemet's membrane from graft
overall length 117 mm



G-14200

PAUFIQUE
KERATOPLASTY KNIFE
2 mm long cutting edge
1.7 mm wide semi-circular tip
overall length 105 mm



G-33670

LOHMANN
LASEK EPI PEELER
"Hockey" knife with
5 mm bottom blade and 2 mm front blade
overall length 123 mm



STILETTO
45° lancet
overall length 53 mm
for instruments with

G-33022
G-33025
G-33026

23 gauge / 0.6 mm
20 gauge / 0.9 mm
19 gauge / 1.1 mm



G-14165 **SATO KNIFE**
1.5 mm cutting edge
pointed tip
overall length 123 mm



G-16200 *DARDENNE*
SATO KNIFE
1.2 mm cutting edge
pointed tip
overall length 123 mm



G-37555 *FOERSTER*
SATO KNIFE
conical shaft
front: 30 gauge / 0.3 mm
rear: 20 gauge / 0.9 mm
overall length 125 mm



G-14162 *HANSEN*
SATO KNIFE
double edge,
for arteriovenous dissection
20 gauge / 0.9 mm
overall length 130 mm





HANSEN
MICRO KNIFE
 for paravasal retinal incision
 during arteriovenous dissection
 20 gauge / 0.9 mm

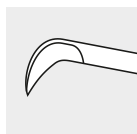

angled blade, 1.0 mm
G-12230

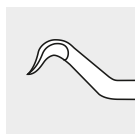

angled blade, 1.2 mm
G-12233



angled blade, 1.5 mm
G-12235

06

MICRO · CRVO



G-12200 **CRVO KNIFE**
 for Radial Opticus Neurotomy (RON)
 with Central Retinal Vein Occlusion (CRVO),
 20 gauge / 0.9 mm
 overall length 120 mm



G-12220 *DITHMAR*
CRVO KNIFE
 with preset incision depths at 1.5 mm,
 for radial opticus neurotomy (RON)
 with Central Retinal Vein Occlusion (CRVO),
 20 gauge / 0.9 mm
 overall length 129 mm

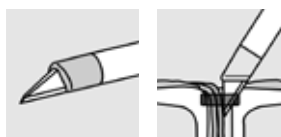

TREPHINES



BEST
TREPHINE
overall length 58 mm



G-31815	1.0 mm
G-31820	1.2 mm
G-31825	1.3 mm
G-31830	1.4 mm

G-31835	1.5 mm
G-31840	1.6 mm
G-31845	1.7 mm
G-31850	1.8 mm

G-31860	2.0 mm
G-31865	2.5 mm

SCHMIDT-MUMM
DUCT TREPHINE
overall length 38 mm



G-20610	1.0 mm
G-20611	1.1 mm
G-20612	1.2 mm

G-20613	1.3 mm
G-20614	1.4 mm
G-20615	1.5 mm

G-20616	1.6 mm
G-20617	1.7 mm
G-20618	1.8 mm

HAMBURG MODEL
KERATOPLASTY TREPHINE
overall length 40 mm



G-20040	4.0 mm
G-20050	5.0 mm
G-20054	5.4 mm
G-20055	5.5 mm

G-20060	6.0 mm
G-20065	6.5 mm
G-20070	7.0 mm
G-20080	8.0 mm

G-20090	9.0 mm
G-20100	10.0 mm
G-20110	11.0 mm
G-20112	12.0 mm

G-20113	13.0 mm
G-20114	14.0 mm
G-20115	15.0 mm
G-20116	16.0 mm

BEST
KERATOPLASTY TREPHINE
overall length 75 mm



G-20450	5.0 mm
G-20455	5.5 mm
G-20460	6.0 mm
G-20465	6.5 mm

G-20470	7.0 mm
G-20480	8.0 mm
G-20490	9.0 mm
G-20500	10.0 mm

G-20510	11.0 mm
G-20520	12.0 mm
G-20530	13.0 mm
G-20540	14.0 mm

G-20550	15.0 mm
G-20560	16.0 mm

FRANCESCHETTI
KERATOPLASTY TREPHINE
overall length 75 mm



G-17250	5.0 mm
G-17260	6.0 mm
G-17261	6.1 mm

G-17270	7.0 mm
G-17271	7.1 mm
G-17280	8.0 mm
G-17281	8.1 mm

G-17290	9.0 mm
G-17291	9.1 mm
G-17300	10.0 mm

MANY TREPHINES ALSO AVAILABLE IN MINUS, INTERMEDIATE AND PLUS SIZES

G-31870

THOMAS NEUHANN

CORNEAL PUNCH

for keratoplasty trephines with thread from G-33870 to G-33899, with silicone block for donor cornea



07

TREPHINES · PUNCH

KERATOPLASTY TREPHINE

with thread, for *NEUHANN* corneal punch G-31870 overall length 40 mm



G-33870	7.0 mm	G-33880	8.0 mm	G-33890	9.0 mm
G-33872	7.2 mm	G-33882	8.2 mm	G-33895	9.5 mm
G-33873	7.3 mm	G-33884	8.4 mm	G-33897	9.7 mm
G-33874	7.4 mm	G-33885	8.5 mm	G-33899	9.9 mm
G-33875	7.5 mm	G-33886	8.6 mm		
G-33876	7.6 mm	G-33887	8.7 mm		
G-33877	7.7 mm				
G-33878	7.8 mm				
G-33879	7.9 mm				

G-32671 *ÖRK LINZ MODEL*
SILICONE BLOCK FOR DMEK
for donor cornea
white-colored
outside diameter 30 mm
height 19 mm
only for single use, not sterile



G-32672 **SILICONE BLOCK**
for donor cornea
blue-colored
outside diameter 30 mm
height 19 mm
only for single use, not sterile

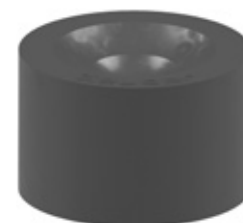

G-32674 **SILICONE BLOCK WITH CENTER POINT**
for donor cornea
blue-colored
outside diameter 20 mm
height 10 mm
only for single use, not sterile



G-38620 *SZURMAN*
DMEK GRAFT RETAINER
for preparation of DMEK graft
white-colored
outside diameter 35 mm
height 10 mm
Teflon, for multiple use



07

SILICONE BLOCKS

GLAUCOMA PUNCHES RONGEURS

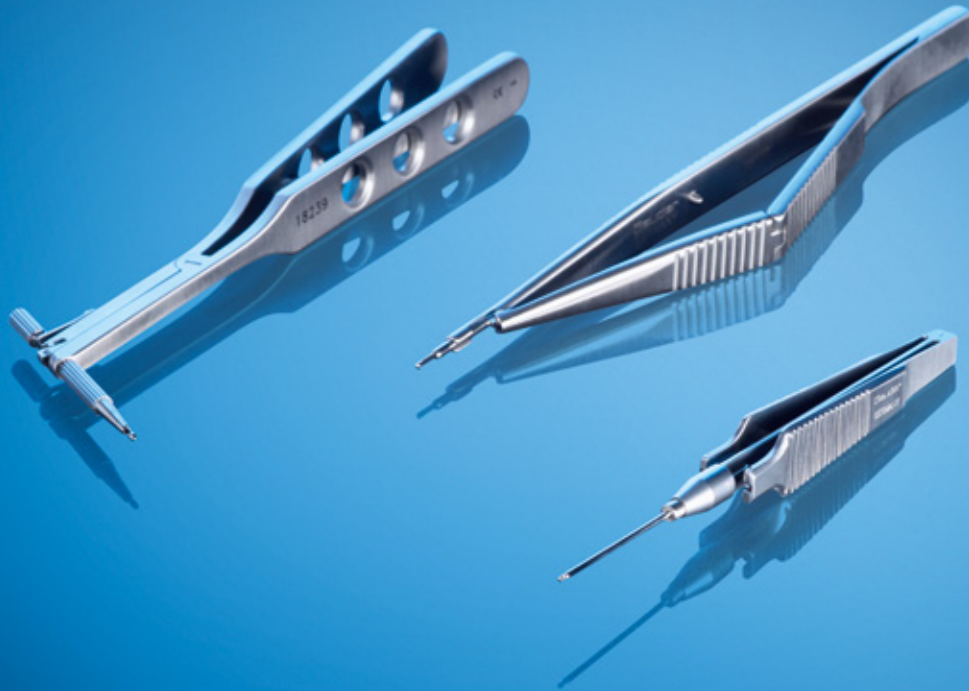

G-18210

CITELLI

BONE NIBBLING RONGEUR

3 mm x 4.5 mm bite
overall length 150 mm



scale 2:5



G-18220

BEYER

BONE NIBBLING RONGEUR

2 mm x 3 mm bite
overall length 140 mm

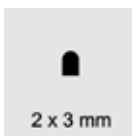

scale 2:5



G-18225

KERRISON

BONE NIBBLING RONGEUR

5 mm x 3.5 mm bite
overall length 160 mm



scale 2:5



08

RONGEURS



G-18238 *KELLY*
DESCEMET'S MEMBRANE PUNCH
 for Glaucoma
 19 gauge / 1.0 mm
 0.9 mm x 0.45 mm bite
 overall length 122 mm

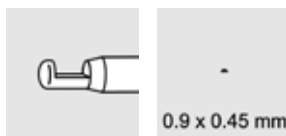

08

GLAUCOMA PUNCHES



G-18239 *LUNTZ-DODICK*
TRABECULECTOMY PUNCH
 for Glaucoma
 with 360° rotatable cutting head
 1 mm x 0.5 mm bite
 overall length 115 mm



G-18235 *GREHN*
MICRO TRABECULECTOMY PUNCH
 for Glaucoma
 20 gauge / 0.9 mm
 0.7 mm x 0.3 mm bite
 overall length 90 mm

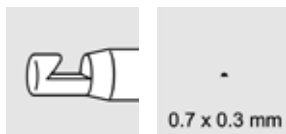



G-18237 *GASS*
CORNEOSCLERAL PUNCH
for Glaucoma
with 360° rotatable cutting head
1.5 mm x 0.6 mm bite
overall length 85 mm



G-18232 *MOHR*
GLAUCOMA PUNCH
1 mm circular bite
overall length 78 mm

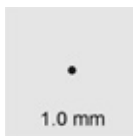

SCISSORS



CORNEAL	81
CORNEAL · STITCH	82
SYNECHIA · TRABECULUM · CAPSULE	83
CAPSULE · IRIS	86
IRIS · IOL	87
TENOTOMY	89
TENOTOMY · STRABISMUS	90
MISCELLANEOUS · RING HANDLE	91
ENUCLEATION	94
VITREORETINAL	95

TROUTMAN

CORNEAL SCISSORS

7 mm blades
9.5 mm from tip to pivot
overall length 100 mm
right, curved blades, blunt tips
left, curved blades, blunt tips

G-19710
G-19715



CASTROVIEJO

CORNEAL SCISSORS

lower blade 9.5 mm
upper blade 9.0 mm
overall length 105 mm
right, curved blades, blunt tips
left, curved blades, blunt tips

G-19690
G-19695



KATZIN

KERATOPLASTY SCISSORS

6 mm blades
8 mm from tip to pivot
overall length 100 mm
right, curved blades, blunt tips
left, curved blades, blunt tips

G-19720
G-19725



G-19718

SAUTTER

CORNEAL SCISSORS

light curve, fine blunt tips
10 mm blades
14 mm from tip to pivot
overall length 100 mm



G-19780

CASTROVIEJO

CORNEAL SCISSORS

strong curve, blunt tips
12 mm blades
15 mm from tip to pivot
overall length 103 mm



G-19790

CASTROVIEJO

CORNEAL SCISSORS

angled to side, blunt tips
12 mm blades
overall length 110 mm



CORNEAL SCISSORS

light curve
8 mm blades
overall length 105 mm
sharp tips
blunt tips

G-19600
G-19605



CORNEAL SCISSORS

strong curve, blunt tips
6 mm blades, overall length 105 mm
11 mm blades, overall length 110 mm

G-19607
G-19615



G-19727

MACKENSEN
KERATOPLASTY SCISSORS
strong curve, blunt tips
overall length 85 mm



G-19585

CORNEAL SECTION SCISSORS
angled up, 8 mm blades
blunt tips
overall length 100 mm



G-19570

MICRO STITCH SCISSORS
straight, 8 mm blades
sharp tips
overall length 105 mm



G-19580

FINE
STITCH SCISSORS
straight, 14 mm blades
sharp tips
overall length 110 mm



09

CORNEAL · CORNEAL SECTION · STITCH

G-19590 *CASTROVIEJO*
ANTERIOR SYNECHIA SCISSORS
angled up
9 mm vaulted blades, blunt tips
overall length 105 mm



G-19740 *CASTROVIEJO*
ANTERIOR SYNECHIA SCISSORS
angled up
15 mm vaulted blades, blunt tips
overall length 115 mm



TRABECULUM SCISSORS
sharp tips
8.5 mm blades
1.5 mm pivot width
overall length 80 mm
G-19745 straight
G-19747 curved



CAPSULOTOMY SCISSORS
angled up, sharp tips
2 mm pivot width
overall length 80 mm
G-19776 9 mm blades
G-19777 11 mm blades



G-32100 **CAPSULOTOMY SCISSORS**
angled, lightly curved tips
13 mm blades
2 mm pivot width
overall length 80 mm



G-32101 **CAPSULOTOMY SCISSORS**
angled, strongly curved tips
13 mm blades
2 mm pivot width
overall length 80 mm



G-32105 **CAPSULOTOMY SCISSORS**
lightly curved, sharp tips
11 mm blades
1.8 mm pivot width
overall length 88 mm



G-32023 **CAPSULOTOMY SCISSORS**
 curved, sharp tips
 7 mm blades
 1.8 mm pivot width
 overall length 80 mm



G-19620 *TUEBINGEN MODEL*
CAPSULOTOMY SCISSORS
 straight, sharp tips
 9 mm blades
 1.8 mm pivot width
 overall length 88 mm



G-19630 *TUEBINGEN MODEL*
CAPSULOTOMY SCISSORS
 curved, sharp tips
 9 mm blades
 1.8 mm pivot width
 overall length 88 mm



G-19760 *VANNAS*
CAPSULOTOMY SCISSORS
 extra delicate, straight
 6 mm blades, sharp tips
 1.7 mm pivot width
 overall length 80 mm



G-19765 *VANNAS*
CAPSULOTOMY SCISSORS
 extra delicate, curved
 6 mm blades, sharp tips
 1.7 mm pivot width
 overall length 80 mm



G-19770 *VANNAS*
CAPSULOTOMY SCISSORS
 extra delicate, angled to side
 7 mm blades, sharp tips
 overall length 80 mm



09

CAPSULOTOMY · CAPSULE

G-19775 *VANNAS*
CAPSULOTOMY SCISSORS
extra delicate, angled up
7 mm blades, sharp tips
overall length 80 mm



G-32940 *H.-R. KOCH*
CAPSULE SCISSORS
horizontal, 45° angled
2.5 mm blades, 360° rotatable head
22 gauge / 0.7 mm straight shaft
overall length 107 mm



G-32942 *BRAUWEILER*
CAPSULE SCISSORS
vertical, 1.25 mm blades
22 gauge / 0.7 mm curved shaft
overall length 100 mm



G-38246 *YAE*
CAPSULE SCISSORS
interchangeable, titanium, gold-colored
3 mm straight micro blades
23 gauge / 0.6 mm curved shaft
for cutting synechia, iridotomies,
and to rescue the rhexis during MICS
overall length 42 mm
for use with handle G-38240



G-38240 *JAPAN MODEL*
HANDLE
for capsule scissors and forceps
6 mm, titanium
overall length 90 mm



09

CAPSULOTOMY · ROTATABLE · INTERCHANGEABLE



OSHER
CAPSULE SCISSORS
 360° rotatable and interchangeable tips
 22 gauge / 0.7 mm
 overall length 45 mm
 to use with handpiece
 G-38215



OSHER
CAPSULE SCISSORS
 horizontal, 45° angled
 G-38236



OSHER
CAPSULE SCISSORS
 horizontal, 90° angled
 G-38238

OSHER
HANDPIECE FOR CAPSULE SCISSORS
 8 mm titanium handpiece, gold-colored
 G-38215



09

CAPSULE (INTERCHANGEABLE AND ROTATABLE) · IRIS

G-32948 *HATTENBACH*
HYBRID SCISSORS
 to cut sutures during iris and dislocated IOL fixation
 1.25 mm blades
 25 gauge / 0.5 mm angled shaft



NOYES
IRIS SCISSORS
 straight
 18 mm blades
 overall length 120 mm
G-19540 sharp tips
G-19545 sharp-blunt
G-19550 blunt tips



WECKER
IRIS SCISSORS
 11 mm blades
 overall length 110 mm
G-19640 sharp tips
G-19655 blunt tips



WECKER
IRIS SCISSORS
7 mm blades
overall length 110 mm
sharp tips
blunt tips

G-19660
G-19675



G-19680 *BARRAQUER*
IRIS SCISSORS
7 mm blades
blunt tips
overall length 56 mm



G-32945 *STEINMETZ*
IOL SCISSORS
6.5 mm upper blade
serrated lower tip with groove
overall length 92 mm
For cutting acrylic and silicone foldable IOLs

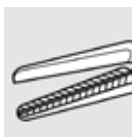

G-32946 *STEINMETZ*
IOL SCISSORS
for small incision technique
6.5 mm upper blade
serrated lower tip with groove
overall length 92 mm
For cutting acrylic and silicone foldable IOLs



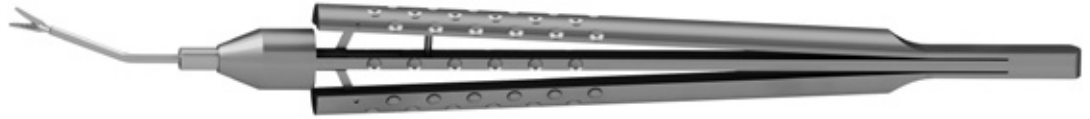

SNYDER-OSHER

IOL SCISSORS

For cutting acrylic and silicone foldable IOLs
 lower notched blade to create IOL traction
 18 gauge / 1.2 mm shaft
 overall length 150 mm

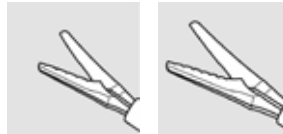

- G-32998** short model, 3.5 mm blades
- G-32996** long model, 4.5 mm blades



G-32800

H.-R. KOCH

SILICONE LENS BI-SECTOR

for dividing implanted silicone lenses
 overall length without wire loop 130 mm
 5 wire loops included (G-32811)

09

WIRE LOOP

for *H.-R. KOCH* silicone lens bi-sector
 (G-32800)
 overall length 65 mm (loop 12 mm)



- G-32810** 1 piece
- G-32811** 5 pieces



**COMBINED
 NEEDLE HOLDER / SCISSORS**

curved 12 mm blades with
 3 mm needle holder and tying platform
 used to hold, place, and cut fine suture material
 overall length 125 mm



- G-17440** without lock
- G-17441** with lock

G-19750 *WESTCOTT*
SCISSORS
blunt tips
curved, standard blades
overall length 120 mm



G-19751 *WESTCOTT*
SCISSORS
pointed tips
curved, standard blades
overall length 120 mm



G-32250 *WESTCOTT*
SCISSORS
blunt tips
curved, delicate blades
overall length 100 mm



STEVENS
TENOTOMY SCISSORS
short blades, blunt tips
22 mm from tip to pivot
overall length 105 mm
G-19470 straight
G-19475 curved



STEVENS
TENOTOMY SCISSORS
long blades, blunt tips
28 mm from tip to pivot
overall length 110 mm
G-19480 straight
G-19485 curved



G-32614

BONN MODEL

TENOTOMY SCISSORS

curved blades, blunt tips
24 mm from tip to pivot
overall length 90 mm



G-19430

BONN MODEL

STRABISMUS SCISSORS

blunt tips
24 mm from tip to pivot
overall length 90 mm

G-19435

straight
curved



G-19420

STRABISMUS SCISSORS

long blade
28 mm from tip to pivot
overall length 105 mm

G-19425

straight
curved



09

TENOTOMY · STRABISMUS · RING HANDLE

STRABISMUS SCISSORS

short blade
28 mm from tip to pivot
overall length 110 mm

G-19460

straight

G-19465

curved



EYE SCISSORS

straight, sharp tips

overall length: tip to pivot:

G-19350

90 mm

27 mm

G-19355

100 mm

29 mm

G-19360

115 mm

30 mm

G-19365

120 mm

36 mm



EYE SCISSORS

curved, sharp tips

overall length: tip to pivot:

G-19370

90 mm

27 mm

G-19375

100 mm

28 mm

G-19380

110 mm

29 mm

G-19385

120 mm

34 mm



EYE SCISSORS

delicate, sharp tips
31 mm from tip to pivot
overall length 105 mm

G-19390

straight

G-19395

curved



BONN MODEL
EYE SCISSORS

extra delicate
sharp tips
19 mm from tip to pivot
overall length 90 mm

G-19400

curved

G-19405

straight



G-19410

SPENCER
STITCH SCISSORS

20 mm straight blades
with hook to lift and
secure sutures before cutting
overall length 90 mm



09

UTILITY · STITCH · RING HANDLE

G-19450 *GRAEFE*
EYE SCISSORS
angled up
blunt tips
overall length 90 mm



G-19505 **EYE SCISSORS**
angled to side, probe tip
sharp-blunt
overall length 115 mm



G-19510 **EYE SCISSORS**
angled to side, probe tips
blunt tips
overall length 115 mm



G-31315

OPERATING SCISSORS

straight blades
sharp-blunt
overall length 145 mm



ENUCLEATION SCISSORS

curved blades, blunt
40 mm from tip to pivot
overall length 135 mm

G-19520

G-19525

G-19530

strong curve
medium curve
light curve



09

UTILITY · ENUCLEATION · RING HANDLE

20 GAUGE

VITREORETINAL SCISSORS

20 gauge / 0.9 mm
titanium handle
gold-colored
overall length 155 mm

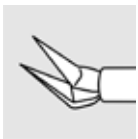
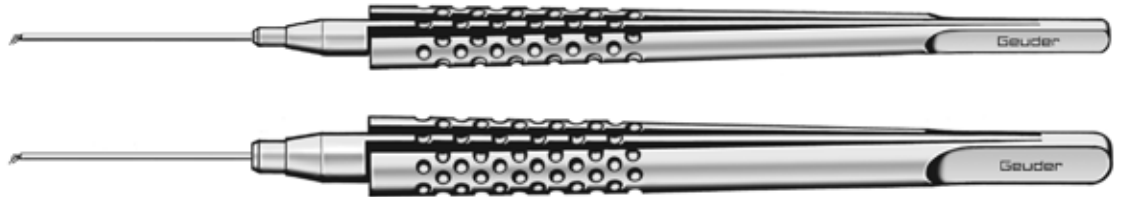

45° angle
horizontal
G-36502 6 mm handle
G-36504 8 mm handle



curved
with membrane peeler
G-36506 6 mm handle



curved
G-36512 6 mm handle
G-36514 8 mm handle



KROLL
angled, with membrane peeler
G-36516 6 mm handle
G-36518 8 mm handle

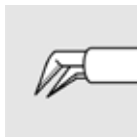

HEIMANN
angled
G-36526 6 mm handle
G-36528 8 mm handle



60° angled
G-36546 6 mm handle

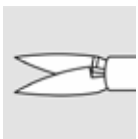

HEIMANN
straight
G-36532 6 mm handle
G-36534 8 mm handle

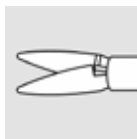

HEIMANN
straight, blunt tips
G-36536 6 mm handle
G-36538 8 mm handle



curved
horizontal
G-36552 6 mm handle
G-36554 8 mm handle



NAITO
long blade 3.5 mm
curved, tapered tip
G-36556 6 mm handle
G-36558 8 mm handle



ROIDER
for RPE transplantation, vitrectomies
and retinectomies
G-36572 6 mm handle
G-36574 8 mm handle

23 GAUGE

VITREORETINAL SCISSORS

23 gauge / 0.6 mm
titanium handle
gold-colored
overall length 155 mm

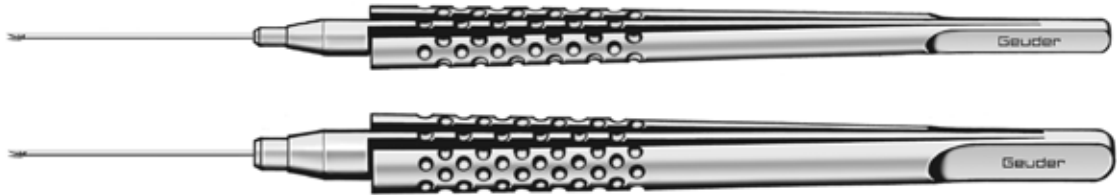

curved
G-36566 6 mm handle
G-36568 8 mm handle

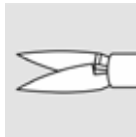

HEIMANN
straight
G-36576 6 mm handle
G-36578 8 mm handle

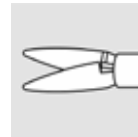

HEIMANN
straight, blunt tips
G-36582 6 mm handle



HEIMANN
for use with 23 gauge trocar system
angled, sharp tips
G-36540 6 mm handle
G-36541 8 mm handle

VITREORETINAL 23 & 25 GAUGE

25 GAUGE

VITREORETINAL SCISSORS

25 gauge / 0.5 mm
titanium handle
gold-colored



curved
G-36562 6 mm handle
G-36564 8 mm handle

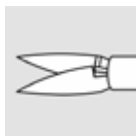

HEIMANN
straight
G-36586 6 mm handle
G-36588 8 mm handle

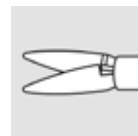

HEIMANN
straight, blunt tips
G-36592 6 mm handle

ERGOLINE

ERGOLINE SCISSORS

360° rotatable and interchangeable tips
for Ergoline handles 6 and 8 mm diameter
overall length 55 mm

ERGOLINE HANDPIECE

for Ergoline scissors
gold-colored
overall length 105 mm

G-36900 6 mm titanium handpiece

G-36901 8 mm titanium handpiece

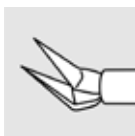

ERGOLINE SCISSORS

45° angled
horizontal
20 gauge / 0.9 mm
G-36902



KROLL

ERGOLINE SCISSORS

angled, with membrane peeler
20 gauge / 0.9 mm
G-36915



HEIMANN

ERGOLINE SCISSORS

angled
20 gauge / 0.9 mm
G-36925

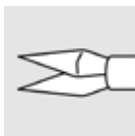

HEIMANN

ERGOLINE SCISSORS

straight
G-36930 20 gauge / 0.9 mm



NAITO

ERGOLINE SCISSORS

long blade 3.5 mm, curved
tip tapered to 0.75 mm
20 gauge / 0.9 mm
G-36955 20 gauge / 0.9 mm



CLEANING ADAPTER

for rotatable and
interchangeable tips
G-36604

SINGLE-USE
INTERCHANGEABLE SCISSORS
AVAILABLE ON P. 221





CILIA · FOREIGN BODY	101
CONJUNCTIVA	102
SUTURING	103
SUTURING · COLIBRI STYLE · CORNEA	104
CORNEA · SUTURING · TYING	105
IRIS	110
CAPSULORHEXIS	113
NUCLEUS · SPREADING	120
IOL	121
MUSCLE	126
VITREORETINAL	128
CHALAZION · PTOSIS	134
MOSQUITO · HEMOSTAT	135
TOWEL CLAMPS · SERREFINES	136

G-18720 *HENRY*
CILIA FORCEPS
straight jaws
smooth, blunt, squared tips
overall length 100 mm



G-18730 *GRADLE*
CILIA FORCEPS
curved jaws
smooth, blunt, squared tips
overall length 98 mm



G-18750 *BARRAQUER*
CILIA FORCEPS
lightly angled
6.5 mm platform
overall length 109 mm



G-18740 *BEER*
CILIA FORCEPS
3 mm platform
rounded tips 4.5 mm wide
overall length 78 mm



G-18850 *SHAAF*
CILIA AND FOREIGN BODY FORCEPS
grooved tips
curved and pointed
finger grip handle
overall length 96 mm



G-31620 *BARRAQUER*
CILIA AND SUTURE FORCEPS
grooved tips, 7.0 mm platform
curved and pointed
finger grip handle
overall length 112 mm



G-32740 *HAMBURG MODEL*
CILIA AND FOREIGN BODY FORCEPS
tapered fine tips
overall length 90 mm



G-31230 *KREFELD MODEL*
CONJUNCTIVA FORCEPS
 standard
 1 x 2 teeth
 overall length 100 mm

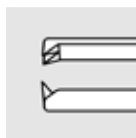

G-31235 *FREIBURG MODEL*
CONJUNCTIVA FORCEPS
 delicate
 1 x 2 teeth
 overall length 90 mm

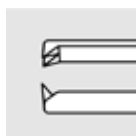

G-18847 *KAUFMANN*
CONJUNCTIVA FORCEPS
 standard
 1 x 2 teeth
 5 mm tying platform
 overall length 75mm

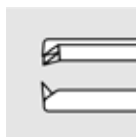

G-18810 *DRAEGER*
CONJUNCTIVA FORCEPS
 1.2 mm wide
 2 atraumatic fixation knobs
 overall length 97 mm

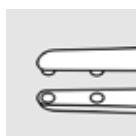

G-18848 *FOERSTER*
CONJUNCTIVA FORCEPS
 delicate
 1 x 2 teeth
 finger grip handle
 overall length 95 mm

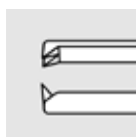



CASTROVIEJO
SUTURING FORCEPS
1 x 2 teeth
6 mm tying platform
overall length 100 mm

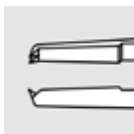

- G-19001** 0.28 mm, teeth 0.12 mm
- G-19005** 0.3 mm
- G-19010** 0.6 mm
- G-19015** 0.9 mm
- G-19020** 1.2 mm



CASTROVIEJO
SUTURING FORCEPS
new model
1 x 2 teeth
6 mm tying platform
overall length 109 mm

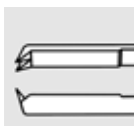

- G-19022** 0.25 mm, teeth 0.12 mm
- G-19023** 0.3 mm
- G-19024** 0.5 mm
- G-19025** 0.9 mm
- G-19026** 1.2 mm



G-19008 *MUNICH MODEL*
SUTURING FORCEPS
1 x 2 teeth, 0.35 mm
5.5 mm tapered tying platform
overall length 100 mm

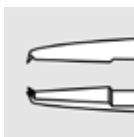

ZUERICH MODEL
SUTURING FORCEPS

delicate
1 x 2 teeth, 0.12 mm
5 mm tying platform
overall length 75 mm

G-18965

G-18966

straight

angled



G-18950

COLIBRI FORCEPS

1 x 2 teeth, 0.12 mm
5 mm tying platform
overall length 75 mm



G-18960

MICRO COLIBRI FORCEPS

delicate
1 x 2 teeth, 0.12 mm
5 mm tying platform
overall length 77 mm



G-15134

MICRO COLIBRI FORCEPS

extra delicate
1 x 2 teeth, 0.12 mm
4 mm tying platform
overall length 76 mm



G-18975

BARRAQUER
SUTURE REMOVING FORCEPS

very fine pointed tips
4 mm tying platform
overall length 77 mm



G-18972

THOMAS NEUHANN
KERATOPLASTY FORCEPS

for corneal suturing and fixation
two prongs with 1 x 2 teeth
0.8 mm prong spread
overall length 80mm



G-18970

REMKY

KERATOPLASTY FORCEPS

two prongs with 1 x 1 teeth, angled
1.7 mm prong spread
for corneal suturing and fixation
overall length 80 mm



G-38623

REMKY

DMEK KERATOPLASTY FORCEPS

modified by *SZURMAN*
two prongs with 1 x 1 teeth, straight
1.7 mm prong spread
33 mm shafts
to hold graft during preparation
overall length 89 mm

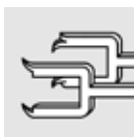

G-18940

G-18945

PAUFIQUE

UNIVERSAL SUTURING FORCEPS

1 x 2 teeth
6 mm tying platform
overall length 88 mm
standard
delicate

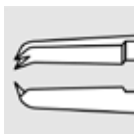

G-19045

G-19046

PAUFIQUE

TYING FORCEPS

with platform
overall length 88 mm
standard, 6 mm platform
delicate, 5 mm platform

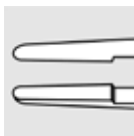

G-19030

TUEBINGEN MODEL

TYING FORCEPS

straight, smooth jaws

6 mm tying platform

overall length 101 mm

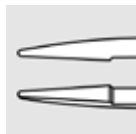

G-19040

TUEBINGEN MODEL

TYING FORCEPS

curved, smooth jaws

6 mm tying platform

overall length 99 mm



G-19035

TUEBINGEN MODEL

TYING FORCEPS

delicate, smooth jaws

4 mm tying platform

overall length 84mm

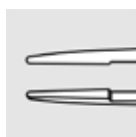

G-19034

BONN MODEL

TYING FORCEPS

extra delicate, smooth jaws

3 mm tying platform

overall length 73 mm

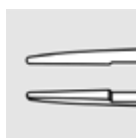

10

TYING

G-19032 **TYING FORCEPS**
angled, 7.5 mm
6 mm tying platform
overall length 99 mm

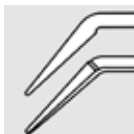

G-31625 *DARDENNE*
TYING FORCEPS
angled, 6.5 mm
6 mm tying platform
round handle with guide pin
overall length 102 mm

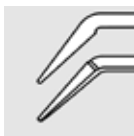

G-19038 *BANGERTER*
TYING FORCEPS
9.5 mm platform
longitudinal v-shape groove
overall length 100 mm



G-19048 **TYING FORCEPS**
utility serrated jaws
1 mm wide
overall length 106 mm



10
TYING

G-32947

HATTENBACH
HYBRID TYING FORCEPS
 angled, for the anterior chamber
 intraocular 1.5 mm micro tying tips
 25 gauge / 0.5 mm
 overall length 98 mm

for use in combination with
 hybrid needle holder G-32949



G-31623

KELMAN-MCPHERSON
FRAGMENT FORCEPS
 angled, smooth jaws
 7.5 mm platform
 overall length 100 mm



G-33941

KELMAN-MCPHERSON
FRAGMENT FORCEPS
 angled, fine grooved jaws,
 for femto-LASIK to retrieve lenticule
 during SMILE procedures
 7.5 mm platform
 overall length 100 mm



G-31622

GASKIN
FRAGMENT FORCEPS
 angled
 with tying platform
 9 mm platform, overall length 107 mm

G-31624

11 mm platform, overall length 100 mm



G-37700 **JEWELERS TYPE FORCEPS**
standard, straight
overall length 120 mm



G-37705 **JEWELERS TYPE FORCEPS**
delicate, straight
overall length 115 mm



G-37710 **JEWELERS TYPE FORCEPS**
extra delicate, straight
overall length 115 mm



G-19080 *BARRAQUER*
FIXATION FORCEPS
3 sets of 1 x 2 teeth
11 mm fixation platform
overall length 100 mm



GRAEFE
FIXATION FORCEPS
4.5 mm wide
8 interlocking teeth
overall length 110 mm
G-19050 without lock
G-19055 with lock

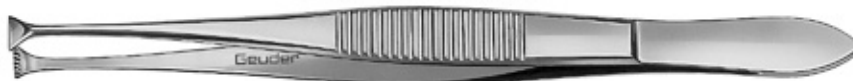

G-19060 *HEIDELBERG MODEL*
FIXATION FORCEPS
3.5 mm wide
6 interlocking teeth
overall length 110 mm

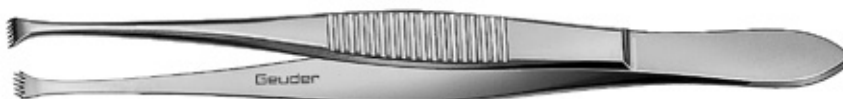

DRESSING FORCEPS

serrated jaws
overall length 100 mm

- G-18780 0.5 mm
- G-18781 0.7 mm
- G-18782 1.0 mm
- G-18783 1.2 mm
- G-18784 1.4 mm

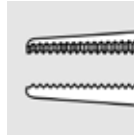

TISSUE FORCEPS

1 x 2 teeth
overall length 100 mm

- G-18790 0.5 mm
- G-18791 0.7 mm
- G-18792 1.0 mm
- G-18793 1.2 mm
- G-18794 1.4 mm

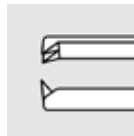

IRIS FORCEPS

serrated, delicate
overall length 73 mm
straight
curved

- G-18855 straight
- G-18856 curved

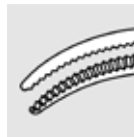

BONN MODEL
IRIS FORCEPS

serrated, extra delicate
overall length 73 mm
straight
angled at 6 mm
angled at 8 mm

- G-18908 straight
- G-18906 angled at 6 mm
- G-18911 angled at 8 mm

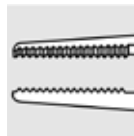

BONN MODEL
IRIS FORCEPS

1 x 2 teeth, 0.12 mm
extra delicate
overall length 73mm
straight
angled at 6 mm
angled at 8 mm

- G-18900 straight
- G-18905 angled at 6 mm
- G-18910 angled at 8 mm

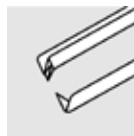

BONN MODEL

IRIS FORCEPS

long, straight
1 x 2 teeth, 0.12 mm
overall length 102 mm

G-18845

extra delicate

G-18890

delicate, with 4.5 mm tying platform

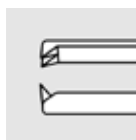

G-18840

SWISS MODEL

IRIS FORCEPS

curved, 1 x 2 teeth
overall length 100 mm

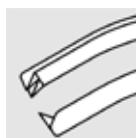

G-18860

HEIDELBERG MODEL

IRIS FORCEPS

light curve, 1 x 2 teeth
overall length 72 mm

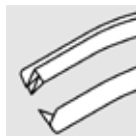

G-18870

HEIDELBERG MODEL

IRIS FORCEPS

strong curve, 1 x 2 teeth
overall length 70 mm



G-18857

IRIS FORCEPS

straight, delicate
1 x 2 teeth
overall length 72 mm

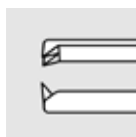

G-31953

IRIS FORCEPS

straight, strong
1 x 2 teeth
overall length 72 mm

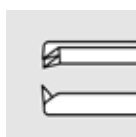

G-18846

HAMBURG MODEL

IRIS FORCEPS

straight, delicate

1 x 2 teeth

overall length 103 mm

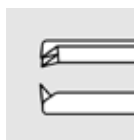

G-32240

SWISS MODEL

IRIS FORCEPS

straight, extra delicate

1 x 2 teeth

overall length 70 mm

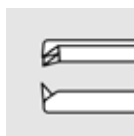

G-18880

HESS-ENGELKING

IRIS FORCEPS

1 x 2 teeth

overall length 72 mm

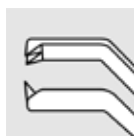

10

IRIS FIXATION

G-18897

ELZE

IRIS FORCEPS

extra delicate

1 x 2 teeth

overall length 78 mm



G-18913

THOMAS NEUHANN

IRIS FORCEPS

curved shaft

1 x 2 teeth

23 gauge / 0.6 mm

overall length 95 mm

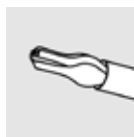

G-31307

UTRATA

CAPSULORHEXIS FORCEPS

strong, with heel stop to protect the iris
interlocking micro serrated tips
12 mm straight shafts
overall length 103 mm

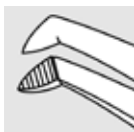

G-31308

CAPSULORHEXIS FORCEPS

round handle with guide pin
extra delicate with
interlocking micro serrated tips
13 mm curved shafts
overall length 105 mm



G-31300

MASKET

CAPSULORHEXIS FORCEPS

delicate, with heel stop to protect the iris
interlocking micro serrated tips
12 mm curved shafts
overall length 103 mm



G-31304

CAPSULORHEXIS FORCEPS

new model, with guide pin
extra delicate with
interlocking micro serrated tips
13 mm curved shafts
overall length 103 mm



G-31301

CAPSULORHEXIS FORCEPS

extra delicate
with smooth triangular grasping tips
13 mm curved shafts
overall length 98 mm



G-31305

CAPSULORHEXIS FORCEPS

extra delicate with
interlocking micro serrated tips
13 mm curved shafts
overall length 98 mm



G-31303

H.-R. KOCH
CAPSULORHEXIS FORCEPS

extra delicate with
interlocking micro serrated tips
13 mm curved shafts
1 mm marks from tip to bent
overall length 98 mm

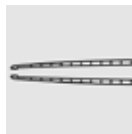

G-31299

CAPSULORHEXIS FORCEPS

short handle, extra delicate
cross serrated grasping tips
12 mm straight shafts
overall length 83 mm

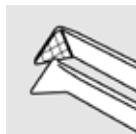

10

CAPSULORHEXIS

G-32926

AUFFARTH

MICS DOUBLE CROSS ACTION CAPSULORHEXIS FORCEPS

interlocking micro serrated tips
12 mm curved shafts, angled 130°
with overlap system
prevents inadvertent iris capture
for 1.6 mm incisions
overall length 100 mm



G-32928

INAMURA

MICS CAPSULORHEXIS FORCEPS

cross action
interlocking micro serrated tips
10.5 mm curved shafts tip to pivot
angled 130°
overall length 103 mm



G-31306

KAMPIK

MICS CAPSULORHEXIS FORCEPS

22 gauge / 0.7 mm curved shaft
90° cystotome tips, reverse action
overall length 93 mm

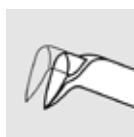

G-32935

H.-R. KOCH

MICS CAPSULE FORCEPS

short handle
22 gauge / 0.7 mm curved shaft with
micro grasping tips
overall length 98 mm



G-19150 *ARRUGA*
CAPSULE FORCEPS
 calibrated, delicate



G-32938 *H.-R. KOCH*
MICS CAPSULE FORCEPS
 22 gauge / 0.7 mm curved shaft with
 micro grasping tips
 6 mm titanium handle, blue-colored
 overall length 144 mm

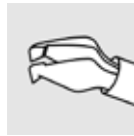

G-32936 *TOBIAS NEUHANN*
MICRO FORCEPS
 multifunction asymmetrical tips with
 grasping platform
 23 gauge / 0.6 mm straight shaft
 6 mm titanium handle, blue-colored
 overall length 155 mm

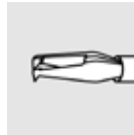

G-32937 *IKEDA*
MICS CAPSULORHEXIS FORCEPS
 23 gauge / 0.6 mm curved shaft with
 micro grasping tips
 6 mm titanium handle, blue-colored
 overall length 144 mm



IKEDA
CAPSULORHEXIS FORCEPS
 interchangeable tips
 23 gauge / 0.6 mm curved shaft
 overall length 40 mm
G-38244 textured, micrograsping tips "BEAK"
G-38242 textured, micrograsping tips



G-38244
 "beak"

G-38242



for use with handle G-38240

10

CAPSULORHEXIS · MICRO INCISION · INTERCHANGEABLE

G-38240 *JAPAN MODEL*
HANDLE
for capsule scissors and forceps
interchangeable tips
6 mm, titanium
overall length 90 mm



G-32944 *HATTENBACH*
CAPSULORHEXIS FORCEPS
25 gauge / 0.5 mm angled shaft with
micro grasping tips
overall length 88 mm

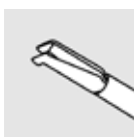

G-18805 *TOBIAS NEUHANN*
DESCEMET MEMBRANE FORCEPS
delicate blunt grasping tips
with platform
overall length 75 mm

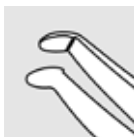

G-38624 *SZURMAN*
DMEK PREPARATION FORCEPS
for removal of Descemet layer
with smooth round tips to prevent tearing
the donor endothelium
overall length 75 mm

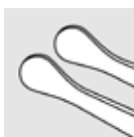

G-38628 *YÖRÜK*
DMEK TRANSPLANT FORCEPS
atraumatic grasping and removal of
Descemet's membrane
grasping area 6 mm
overall length 77 mm

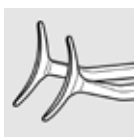



G-38634 *GERTEN*
DSAEK/DMEK RHEXIS FORCEPS
 for Descemetorhexis
 reversed triangular tips to
 score and remove the DM from the host cornea
 23 gauge / 0.6 mm curved shaft
 overall length 142 mm



G-38603 **DSAEK IMPLANTATION FORCEPS**
 13 mm curved shafts with limited closing
 to avoid injury of endothelial transplant
 1.5 mm serrated platform
 overall length 107 mm

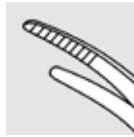

G-38606 *THOMAS NEUHANN*
DSAEK FORCEPS
 1 x 2 teeth, 0.12 mm
 21 gauge / 0.8 mm curved shaft
 for endothelial transplant procedures
 overall length 97 mm



G-33428 *PFAEFFL*
FLAPORHEXIS FORCEPS
 2.5 mm x 1.5 mm cross serrated tips, oval
 to lift femto-LASIK flaps
 overall length 103 mm

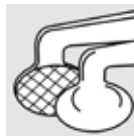

G-33429

KNORZ

FEMTO-LASIK FLAP FORCEPS

curved 3.25 mm T-bar
textured
to grasp and lift LASIK flaps
overall length 102 mm



G-31899

LASIK CORNEAL FLAP FORCEPS

angled shafts, 9 mm
highly polished round and smooth shafts
overall length 108 mm

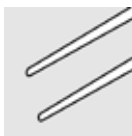

G-18914

BURATTO

LASIK CORNEAL FLAP FORCEPS

curved shafts
cross serrated tips, 0.8 mm diameter
overall length 100 mm

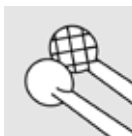

G-33960

RUPAL SHAH

LENTICULE FORCEPS

3.5 mm serrated tips
20 gauge / 0.9 mm curved shaft
to retrieve lenticule during SMILE procedures
6 mm titanium handle, blue-colored
overall length 144 mm



G-33961

LENTICULE FORCEPS

7.5 mm shafts
with fine grooves
angled to side
to retrieve lenticule during SMILE procedures
overall length 99 mm

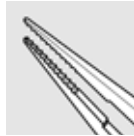

G-31518

NUCLEUS SPREADING FORCEPS

cross-action
3.0 mm textured paddle tips
for cracking the nucleus
overall length 112 mm

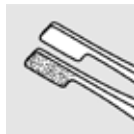

G-31519

AKAHOSHI

NUCLEUS SPREADING FORCEPS

phaco prechopper
4.5 mm delicate sharp tips, 1 mm profile
2.0 mm cross-action
for cracking, dividing, and rotating the nucleus
overall length 105 mm



G-31720

AKAHOSHI

PRECHOPPER

for micro-incisions, straight shafts, cross action
round handle
overall length 125 mm

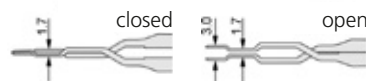



G-31722 *AKAHOSHI*
HYBRID COMBO PRECHOPPER
for micro-incisions, cross action, straight
round handle
length of tip 5.3 mm
overall length 120 mm



G-31724 *AKAHOSHI*
UNIVERSAL PRECHOPPER
for micro-incisions, cross action, straight
round handle
overall length 120 mm



G-33440 *VON BARSEWISCH*
ANTERIOR CHAMBER FORCEPS
extra delicate
8.5 mm angled shafts
1.5 mm platform
overall length 72 mm



G-32165 *FECHNER*
IMPLANTATION FORCEPS
smooth curved shafts
overall length 80 mm

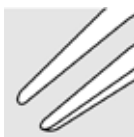

G-18935

DODEN
IMPLANTATION FORCEPS
 curved
 delicate lens holding shafts
 overall length 110 mm



G-18930

SHEPARD
IMPLANTATION FORCEPS
 curved, 1.4 mm disc-shaped tips
 delicate lens holding shafts
 overall length 120 mm



G-31962

KOHLEN
IMPLANTATION FORCEPS
 silicone tube coated
 10 mm angled shafts
 overall length 107 mm

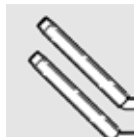

G-18918

DICK
FIXATION AND HOLDING FORCEPS
 for Artisan/Verisyse IOL
 with guide mark for lens maximum hold
 and stability
 18 gauge / 1.2 mm curved shaft
 overall length 143



10

IOL IMPLANTATION · SILICONE COATED

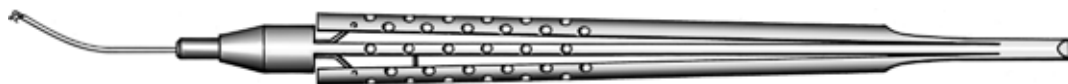

G-18919 *DICK*
IOL HAPTIC EXPANDER
for enclavation of iris-fixated IOLs
21 gauge / 0.8 mm curved shaft
overall length 140 mm



G-18944 *TOBIAS NEUHANN*
IMPLANTATION FORCEPS
for retropupillary implantation of Iris-Claw-IOL
0.9 mm wide holding surface
20 gauge / 0.9 mm curved shaft
overall length 143 mm

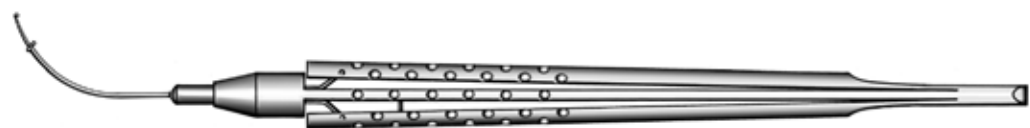

G-18928 *SEKUNDO*
IMPLANTATION FORCEPS
for retropupillary implantation of Iris-Claw-IOL
20 gauge / 0.9 mm curved shaft with
lens holding plate, three-point fixation
and IOL centration guide mark
6 mm titanium handle, blue-colored
overall length 143 mm



G-31902 **FOLDER**
foldable IOL insertion forceps
cross action
6.5 mm concave jaws
overall length 103 mm



G-31903

SPALECK
FOLDER

foldable IOL insertion forceps
for silicone and acrylic IOLs
angled shafts, concave jaws
overall length 102 mm



G-31908

FOLDER

IOL folding forceps
for easy pickup and folding acrylic IOLs
overall length 105 mm

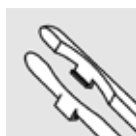

G-31994

H.-R. KOCH
PREFOLDER

for foldable silicone, hydrogel or acrylic IOLs
overall length 135 mm



G-31905

H.-R. KOCH
FOLDER

for foldable 3-piece IOLs
6.0 mm concave jaws
overall length 92 mm



G-31901 **HOLDING FORCEPS**
for foldable IOLs
highly polished round and smooth shafts
overall length 108 mm

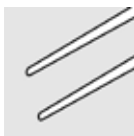

G-18941 *STROBEL*
HOLDING FORCEPS
for Pharmacia CeeOn Edge IOL
overall length 110 mm



G-32823 **EXPLANTATION FORCEPS**
for soft IOLs
2.0 mm x 1.4 mm paddle tip with
interlocking serrations and guide pin
overall length 108 mm

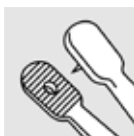

G-32997 *SNYDER-OSHER*
IOL FORCEPS
to hold the IOL while cutting it inside
the capsular bag
2 mm long jaws with 0.5 mm serrated tips
22 gauge / 0.7 mm lightly curved shaft
overall length 99 mm

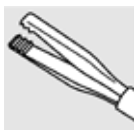

G-18820

REMKY
SUPERIOR RECTUS FORCEPS
 angled
 1 x 2 teeth
 overall length 109 mm

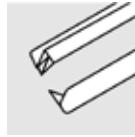

G-18800

ELSCHNIG
SUPERIOR RECTUS FORCEPS
 standard, straight
 1 x 2 teeth
 overall length 110 mm

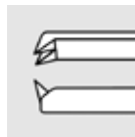

G-18795

ELSCHNIG
SUPERIOR RECTUS FORCEPS
 delicate, straight
 1 x 2 teeth
 overall length 100 mm

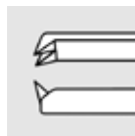

G-19105

LEYDHECKER
SUPERIOR RECTUS FORCEPS
 curved, tip width 0.8 mm
 1 x 2 teeth, 1.1 mm
 overall length 110 mm

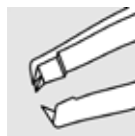

G-32335 *CASTROVIEJO*
SUPERIOR RECTUS FORCEPS
angled with tying platform
1 x 2 teeth, 0.9 mm
overall length 100 mm

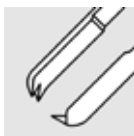

G-19112 *BANGERTER*
MUSCLE FORCEPS
10 teeth
self retaining
overall length 100 mm



G-19120 *SATTLER*
MUSCLE FORCEPS
with slide lock
overall length 100 mm
G-19125 3 teeth, bulbous tip, right
3 teeth, bulbous tip, left



G-32350 *TROELTSCH*
NASAL FORCEPS
serrated tips
for packing and dressing during ENT procedures
overall length 150 mm



G-19107 *ESSEN MODEL*
CERCLAGE FORCEPS
strongly curved
3 mm platform with dual grooves
overall length 104 mm





G-33434 *PFENNIGWERTH*
HOLDING FORCEPS
for vitreoretinal lenses
curved with concave lens holding tips
overall length 110 mm



G-33438 **FORCEPS**
for *HEIMANN* retinal tacks
overall length 100 mm

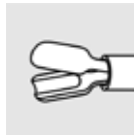

G-33439 **SCLERAL PLUG FORCEPS**
cross action handle, angled jaws
to securely hold plugs during insertion
and removal
overall length 105 mm

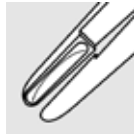

G-31570 **SCLERAL PLUG FORCEPS**
to securely hold plugs during insertion
and removal
overall length 100 mm

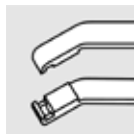

G-33432
SCLERAL PLUG
serrated,
20 gauge / 0.9 mm

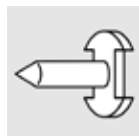

G-33436
SCLERAL PLUG
to suture onto sclera
20 gauge / 0.9 mm



G-33435
SCLERAL PLUG
20 gauge / 0.9 mm



G-33441
SCLERAL PLUG
23 gauge / 0.6 mm

G-33752 *WATZKE*
SPREADING FORCEPS
to stretch silicone sleeves
cross action handle and
serrated tips
overall length 115 mm



G-33032 *HOERAUF*
SPREADING FORCEPS
for silicone oil removal



G-37420 *BARTZ-SCHMIDT*
TROCAR CLOSURE FORCEPS
with function for bulbus fixation
overall length 72 mm



G-37430 **TROCAR FORCEPS**
for trocar systems with groove
overall length 110 mm



G-33831 *REIMANN*
VITREORETINAL FORCEPS
for foreign body removal
with retractable magnet and 3-prongs
14 gauge / 2.1 mm straight shaft
shaft length 35 mm
overall length 138 mm

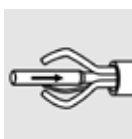

20 GAUGE

VITREORETINAL FORCEPS

20 gauge / 0.9 mm
6 mm and 8 mm diameter handles
titanium, blue-colored
overall length 155 mm

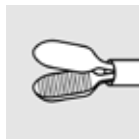
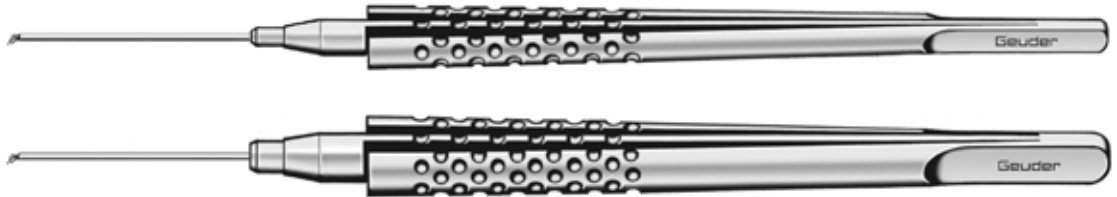

straight
serrated tips
G-36202 6 mm handle
G-36204 8 mm handle

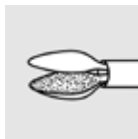

straight
textured tips
G-36206 6 mm handle
G-36208 8 mm handle

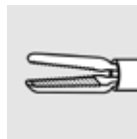

straight
serrated "crocodile" tips
G-36256 6 mm handle
G-36258 8 mm handle

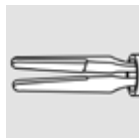

straight
silicone coated
G-36212 6 mm handle
G-36214 8 mm handle

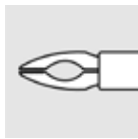

TANO
straight, serrated tips
G-36356 6 mm handle
G-36358 8 mm handle

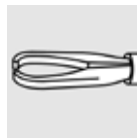

A. MUELLER
for retinal vessels / sheatotomy
G-36334 8 mm handle

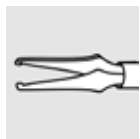

straight
grip tips
G-36216 6 mm handle
G-36218 8 mm handle



90° angle
pointed tips
G-36278 8 mm handle

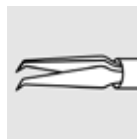

NAITO
ILM
G-36316 6 mm handle
G-36318 8 mm handle

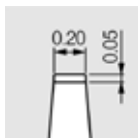
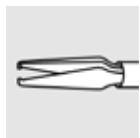

straight
endgripping, extra delicate
0.2 mm x 0.05 mm
G-36292 6 mm handle
G-36294 8 mm handle

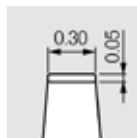
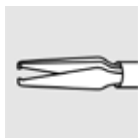

straight
endgripping, extra delicate
0.3 mm x 0.05 mm
G-36296 6 mm handle
G-36298 8 mm handle

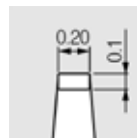
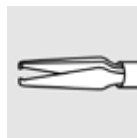

straight
endgripping, delicate
0.2 mm x 0.1 mm
G-36302 6 mm handle

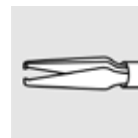

straight
endgripping
0.3 mm x 0.1 mm
G-36306 6 mm handle

10
VITREORETINAL 20 GAUGE

20 GAUGE

VITREORETINAL FORCEPS

20 gauge / 0.9 mm
6 mm and 8 mm diameter handles
titanium, blue-colored
overall length 155 mm

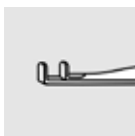

90° angle
membrane peeler
G-36228 8 mm handle



45° angle
membrane peeler
G-36232 6 mm handle



45° angle
G-36222 6 mm handle



membrane peeler tips
G-36252 6 mm handle
G-36254 8 mm handle



curved
membrane dissector
G-36266 6 mm handle



45° angle
membrane dissector
G-36272 6 mm handle
G-36274 8 mm handle

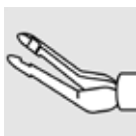

45° angle
horizontal subretinal
G-36236 6 mm handle
G-36238 8 mm handle



45° angle, vertical tips
subretinal
G-36246 6 mm handle
G-36248 8 mm handle



angled, extra delicate
3.0 mm tips
G-36336 6 mm handle

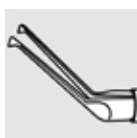

angled, extra delicate
4.5 mm tips
G-36326 6 mm handle
G-36328 8 mm handle

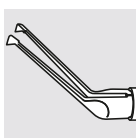

KIRCHHOF
angled, extra delicate
4.5 mm tips with hooks
for RPE translocation
G-36352 6 mm handle

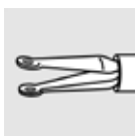

straight
circular tips
G-36242 6 mm handle

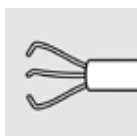

foreign body forceps
G-36262 6 mm handle
G-36264 8 mm handle

23 GAUGE

VITREORETINAL FORCEPS

23 gauge / 0.6 mm
 6 mm and 8 mm diameter handles
 titanium, blue-colored
 overall length 155 mm

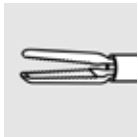
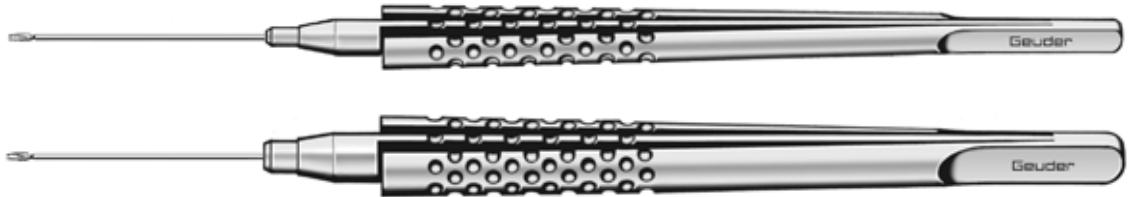

straight
 serrated "crocodile" tips

G-36342 6 mm handle
G-36344 8 mm handle

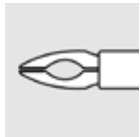

TANO
 straight, serrated tips

G-36362 6 mm handle
G-36364 8 mm handle

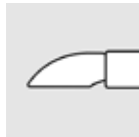

straight
 endgripping, extra delicate
 0.2 mm x 0.05 mm

G-36282 6 mm handle
G-36284 8 mm handle

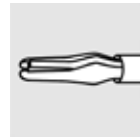
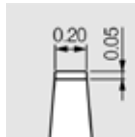

straight
 grip tips

G-36286 6 mm handle
G-36288 8 mm handle

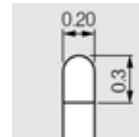

25 GAUGE

VITREORETINAL FORCEPS

25 gauge / 0.5 mm
 6 mm and 8 mm diameter handles
 titanium, blue-colored
 overall length 155 mm

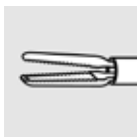

straight
 serrated "crocodile" tips

G-36322 6 mm handle
G-36324 8 mm handle

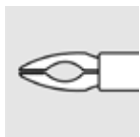

TANO
 straight, serrated tips

G-36366 6 mm handle
G-36368 8 mm handle

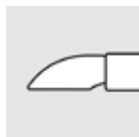

straight
 endgripping, extra delicate
 0.2 mm x 0.05 mm

G-36312 6 mm handle
G-36314 8 mm handle

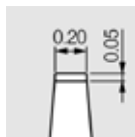

ERGOLINE

ERGOLINE FORCEPS

360° rotatable and interchangeable tips
overall length 55 mm
for Ergoline handpieces 6 mm and 8 mm diameters

ERGOLINE HANDPIECE

for Ergoline forceps
blue-colored
G-36600 6 mm titanium handpiece
G-36601 8 mm titanium handpiece

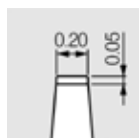
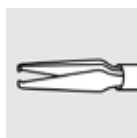
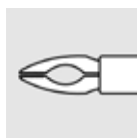

TANO

ERGOLINE FORCEPS

straight, serrated tips
G-36755 20 gauge / 0.9 mm
G-36765 23 gauge / 0.6 mm

ERGOLINE FORCEPS

endgripping
extra delicate 0.2 mm x 0.05 mm
G-36690 20 gauge / 0.9 mm
G-36680 23 gauge / 0.6 mm
G-36710 25 gauge / 0.5 mm

SINGLE-USE
INTERCHANGEABLE FORCEPS
AVAILABLE ON P. 222



G-18680 *LAMBERT*
CHALAZION FORCEPS
 round, 9 mm inside diameter
 solid and fenestrated plates
 overall length 92 mm



G-18670 *AYER*
CHALAZION FORCEPS
 round, 8 mm inside diameter
 interlacing tips
 solid and fenestrated plates
 overall length 90 mm



DESMARRES
CHALAZION FORCEPS
 oval
 solid and fenestrated plates
G-18685 20 mm, overall length 88 mm
G-18690 25 mm, overall length 90 mm
G-18695 31 mm, overall length 95 mm



G-18700 *CAUER*
CHALAZION FORCEPS
 oval, 13 mm x 11 mm inside diameter
 interlacing serrated tips
 solid and fenestrated plates
 overall length 99 mm



G-18710 *LORDAN*
CHALAZION FORCEPS
 triangular, 13 mm x 8 mm inside diameter
 solid and fenestrated plates
 overall length 95 mm



G-18715 *BERKE*
PTOSIS FORCEPS
 22 mm long serrated tips
 slide lock mechanism
 overall length 110 mm



HARTMANN
MOSQUITO FORCEPS
serrated
18 mm jaws
overall length 100 mm
straight
curved

G-18170
G-18171



HALSTEAD
MOSQUITO FORCEPS
serrated
25 mm jaws
overall length 125 mm
straight
curved

G-18180
G-18181

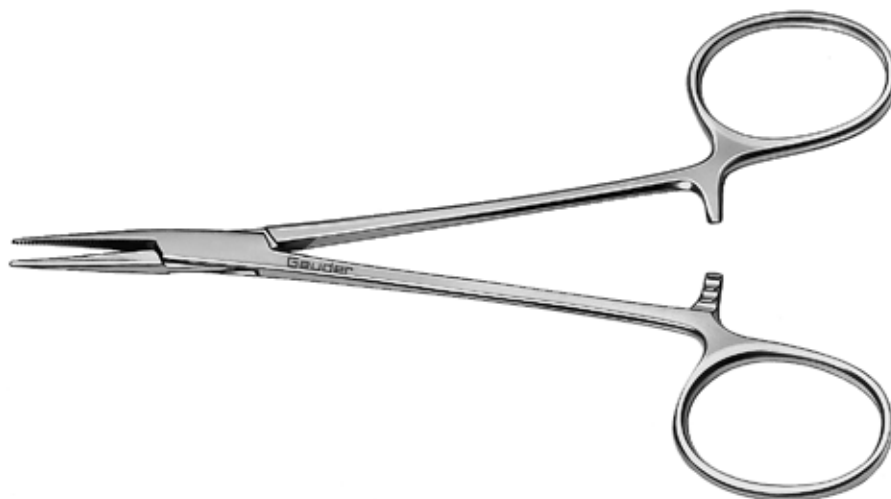

HALSTEAD
MOSQUITO FORCEPS
1 x 2 teeth
serrated
25 mm jaws
overall length 125 mm
straight
curved

G-18185
G-18182



G-18160 *BACKHAUS*
TOWEL FORCEPS
overall length 90 mm



G-33200 *SCHAEDEL*
TOWEL FORCEPS
overall length 90 mm



G-18190 *DIEFFENBACH*
SERREFINE
straight, overall length 35 mm



G-18195 *DIEFFENBACH*
SERREFINE
curved, overall length 35 mm



G-31420 *DIEFFENBACH*
SERREFINE
straight, overall length 50 mm



G-31415 *DIEFFENBACH*
SERREFINE
curved, overall length 50 mm



G-18197 **SERREFINE**
extra delicate, overall length 30 mm



NEEDLE HOLDERS



BARRAQUER

NEEDLE HOLDER

10 mm delicate jaws
0.8 x 0.55 mm tip
overall length 120 mm
curved, without lock
curved, with lock

G-17500
G-17501



BARRAQUER

NEEDLE HOLDER

10 mm delicate jaws
0.8 x 0.45 mm tip
overall length 120 mm
curved, without lock
curved, with lock

G-17505
G-17506



JACOBI

NEEDLE HOLDER

5 mm extra delicate jaws
1.0 x 0.5 mm tips
overall length 115 mm
straight, without lock
straight, with lock

G-17451
G-17453



JACOBI

NEEDLE HOLDER

5 mm extra delicate jaws
1.0 x 0.5 mm tips
overall length 115 mm
curved, without lock
curved, with lock

G-17450
G-17452



BARRAQUER

NEEDLE HOLDER

7.5 mm extra delicate jaws
0.6 x 0.3 mm tip
overall length 105 mm
straight, without lock
straight, with lock

G-17461
G-17463



BARRAQUER

NEEDLE HOLDER

7.5 mm extra delicate jaws
0.6 x 0.3 mm tip
overall length 105 mm
curved, without lock
curved, with lock

G-17460
G-17462



BARRAQUER-TROUTMAN
NEEDLE HOLDER

10 mm extra delicate jaws
0.8 x 0.6 mm tip
handle diameter 6 mm
overall length 100 mm
straight, without lock
straight, with lock

G-32260

G-32261



BARRAQUER-TROUTMAN
NEEDLE HOLDER

10 mm extra delicate jaws
0.8 x 0.6 mm tip
handle diameter 6 mm
overall length 100 mm
curved, without lock
curved, with lock

G-17535

G-17530



BARRAQUER
NEEDLE HOLDER

11 mm delicate jaws
0.9 x 0.8 mm tips
handle diameter 8 mm
overall length 140 mm
curved, without lock
curved, with lock

G-17510

G-17511



BARRAQUER
NEEDLE HOLDER

11 mm extra delicate jaws
0.9 x 0.55 mm tips
handle diameter 8 mm
overall length 140 mm
curved, without lock
curved, with lock

G-17515

G-17516





BARRAQUER
NEEDLE HOLDER
11 mm delicate jaws
1.1 x 0.75 mm tips
handle diameter 10 mm
overall length 140 mm
curved, without lock
curved, with lock

G-17520
G-17525



BARRAQUER
NEEDLE HOLDER
curved, without lock
8 mm standard jaws
1.2 x 0.8 mm tips
original model with longitudinal groove
handle diameter 10 mm
overall length 130 mm



G-32315



BARRAQUER
NEEDLE HOLDER
12 mm standard jaws
1.6 x 1.0 mm tips
handle diameter 10 mm
overall length 140 mm
curved, without lock
curved, with lock

G-32320
G-32321

CASTROVIEJO
NEEDLE HOLDER

short model
9 mm extra delicate jaws
0.9 x 0.55 mm tips
overall length 90 mm
straight, without lock
straight, with lock

G-17545
G-17540



CASTROVIEJO
NEEDLE HOLDER

10.5 mm delicate jaws
1.5 x 0.8 mm tips
overall length 140 mm
straight, without lock
straight, with lock

G-17560
G-17565



CASTROVIEJO
NEEDLE HOLDER

10.5 mm delicate jaws
1.5 x 0.8 mm tips
overall length 140 mm
curved, without lock
curved, with lock

G-17570
G-17575



COMBINED NEEDLE HOLDER / SCISSORS
curved 12 mm blades with
3 mm needle holder and tying platform
used to hold, place and cut fine suture material
overall length 125 mm



G-17440

without lock

G-17441

with lock



G-32949

HATTENBACH

HYBRID NEEDLE HOLDER

angled, for the anterior chamber
25 gauge / 0.5 mm
overall length 90 mm



for use in combination with
hybrid tying forceps G-32947



KALT
NEEDLE HOLDER

standard jaws
serrated, with longitudinal groove
thumb rest and catch
overall length 135 mm

G-17610

straight, cross serrated jaws

G-17615

curved, cross serrated jaws

*ARRUGA***NEEDLE HOLDER**

14 mm heavy jaws
thumb rest and catch
overall length 140 mm
straight, smooth jaws
curved, smooth jaws

G-17640**G-17645****G-17660***HEIDELBERG MODEL***NEEDLE HOLDER**

straight
14 mm heavy jaws
with ratchet lock
overall length 125 mm

*BOYNTON***NEEDLE HOLDER**

straight
with ratchet lock
overall length 120 mm

G-17650**G-17665***ROHRSCHEIDER***NEEDLE HOLDER**

straight
13 mm heavy jaws
1.3 x 1.5 mm tips
overall length 100 mm

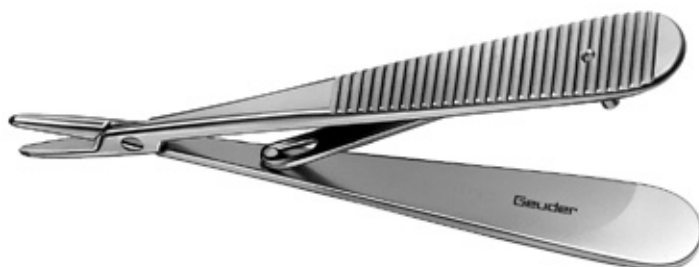

- G-19270** *BARRAQUER*
RAZOR BLADE HOLDER
flat handle
overall length 110 mm



- G-19320** *CASTROVIEJO*
RAZOR BLADE HOLDER
6 mm round handle
overall length 120 mm



- G-19330** *TROUTMAN*
RAZOR BLADE HOLDER
straight
6 mm round handle
overall length 95 mm



- G-18150** **HOLDER FOR ABSORBENT STRIPS**
serrated
to secure sterile absorbent swabs (G-18127)
overall length 175 mm

MANIPULATORS CHOPPERS, FIXATION RINGS HOOKS, SPATULAS LENS LOOPS



FIXATION RINGS	149
FIXATION RINGS · NUCLEUS CHOPPERS	151
NUCLEUS AND LENS MANIPULATORS	155
LENS MANIPULATORS · POSITION HOOKS · IRIS HOOK	157
NUCLEUS SPATULAS	158
CAPSULE POLISHERS	160
LENS LOOPS	161
ORBITAL SPATULAS	163
KERATOPLASTY · SYNECHIAE SPATULAS	164
CYCLODIALYSIS SPATULAS	165
IRIS SPATULAS	166
ENUCLEATION · LASIK SPATULAS	168
DMEK HOOKS · DSAEK GLIDE	169
FEMTOSECOND LASIK MANIPULATORS	170
STRABISMUS HOOKS	174
MEMBRANE SPATULAS AND PEELERS	176

G-37440

HATTENBACH
GLOBE FIXATION RING
for transconjunctival PPV
12 mm inside diameter



G-33755

THORNTON
FIXATION RING
16 mm inside diameter
12 atraumatic teeth



G-31490

FINE-THORNTON
FIXATION RING
for clear cornea and refractive procedures
16 mm inside diameter, 10 mm opening
12 atraumatic teeth



G-31491

FINE-THORNTON
FIXATION RING
for clear cornea and refractive procedures
13 mm inside diameter, 10 mm opening
9 atraumatic teeth





G-33757 *FINE-THORNTON*
FIXATION RING
for clear cornea and refractive procedures
swivel handle
16 mm inside diameter, 10 mm opening
12 atraumatic teeth



G-33758 *FINE-THORNTON*
FIXATION RING
for clear cornea and refractive procedures
swivel handle
13 mm inside diameter, 10 mm opening
9 atraumatic teeth



G-33759 *FINE-THORNTON*
FIXATION RING
for clear cornea and refractive procedures
swivel handle
13 mm inside diameter, 10 mm opening
9 atraumatic teeth, blunt



blunt



G-37425 **FIXATION, HOLDING AND MEASURING INSTRUMENT**
for trocar system, radius 3.5 mm



G-33708 *FOERSTER*
FIXATION RING WITH SCLERAL DEPRESSOR
inside diameter 6.5 mm



YAMANE

DOUBLE NEEDLE STABILIZER

Fixation ring for intrascleral IOL fixation
with double needle technique
overall length 110 mm



G-31496

for 30 gauge needles

G-31497

for 27 gauge needles

FLIERINGA

SCLERAL FIXATION RING

G-15065

15 mm

G-15070

16 mm

G-15075

17 mm

G-15080

18 mm

G-15085

19 mm

G-15090

20 mm



G-32505

THOMAS NEUHANN

NUCLEUS DIVIDING HOOK

for vertical chopping techniques

0.5 mm wide fine tip

overall length 108 mm



MIYOSHI

NUCLEUS DIVIDING HOOK

1 mm tip, 0.6 mm inner edge

overall length 104 mm

G-31500

universal

G-31501

for use in left hand

G-31502

for use in right hand

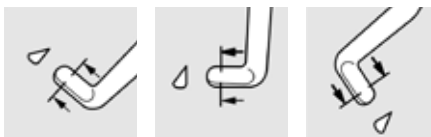

universal
G-31500

left hand
G-31501

right hand
G-31502

G-31504

VÖLCKER
NUCLEUS DIVIDING HOOK
for narrow pupils
with outer notch to push iris aside
1.5 mm inner edge
overall length 104 mm



G-31503

ZIRM
NUCLEUS DIVIDING HOOK
1.5 mm inner edge
overall length 104 mm

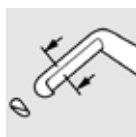

G-31509

JACOBOVITZ
MULTIFUNCTIONAL CHOPPER
cleaver-shaped tip
with distal nucleus chopper
and proximal retractor to manipulate,
divide and crack the nucleus
tip height 1.20 mm
tip width 0.13 mm

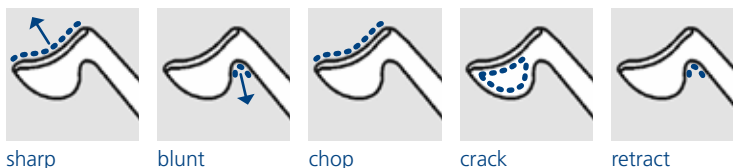

G-32500

TOBIAS NEUHANN
CHOPPER
paddle shape nucleus divider
0.5 mm wide tip
overall length 108 mm

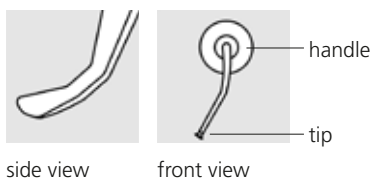

NUCLEUS CHOPPERS

12

G-32282

AGARWAL
KARATE PHACO CHOPPER
0.9 mm long tip
0.6 mm inner edge
overall length 104 mm



G-31505

HAEFLIGER
NUCLEUS DIVIDING HOOK
to crack, chop and manipulate lenses
1.0 mm triangular tip
0.7 mm inner sharp hook
overall length 104 mm



G-31506

for use in right hand
for use in left hand

G-31507

NAGAHARA
NUCLEUS DIVIDING HOOK
for horizontal chopping techniques
1.5 mm long tip
0.9 mm inner edge
overall length 98 mm



G-32501

THOMAS NEUHANN
NUCLEUS ROTATOR and
TOBIAS NEUHANN
CHOPPER
combination of
horizontal Y-shaped nucleus rotator and
paddle shaped nucleus divider
overall length 119 mm

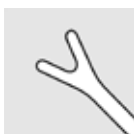

like G-32160



like G-32500

G-32168

THOMAS NEUHANN
SPATULA and
NAGAHARA
NUCLEUS DIVIDING HOOK

combination of
0.5 mm wide phaco spatula and
horizontal phaco chopper
overall length 116 mm



like G-16189



like G-31507

G-32161

THOMAS NEUHANN
NUCLEUS ROTATOR AND DIVIDING HOOK

combination of
horizontal Y-shaped nucleus rotator and
vertical phaco chopper
overall length 117 mm

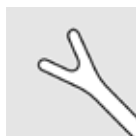

like G-32160



like G-32505

G-32164

THOMAS NEUHANN
SPATULA AND NUCLEUS DIVIDING HOOK

combination of
0.5 mm wide phaco spatula and
vertical phaco chopper
overall length 125 mm



like G-16189



like G-32505

G-32162

THOMAS NEUHANN
IRIS HOOK AND NUCLEUS DIVIDING HOOK

combination of push-pull iris hook and
NEUHANN vertical chopper
overall length 120 mm



like G-16175



like G-32505



G-32169

KOHNEN

IRIS HOOK AND NUCLEUS DIVIDING HOOK

combination of push-pull iris hook and
NAGAHARA horizontal chopper
overall length 114 mm



like G-16175



like G-31507



LIEBERMAN

MICROFINGER

Nucleus Manipulator
1.5 mm curved microfinger
overall length 103 mm

G-16181

for use in right hand

G-16182

for use in left hand



G-31727

AKAHOSHI

NUCLEUS SUSTAINER

to manipulate and sustain nucleus
used in combination with prechopper
0.5 mm ball tip
1.8 mm angled
overall length 100 mm



G-16185

DRYSDALE

**NUCLEUS MANIPULATOR AND
ANTERIOR CAPSULE POLISHER**

to manipulate, rotate, and divide the nucleus
1.0 mm x 1.5 mm paddle shaped tip
overall length 100 mm



G-32160

THOMAS NEUHANN
NUCLEUS ROTATOR

horizontal Y-shaped rotator and manipulator
0.15 mm diameter tip
overall length 104 mm

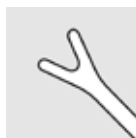

G-32034

HENNIG / FRIEDRICH
LENS EXTRACTION HOOK

(Hefri Hook)
overall length 105 mm



G-32550

MAINZ MODEL
LENS MANIPULATOR

straight
0.15 mm diameter tip
overall length 114 mm



G-32556

MAINZ MODEL
MANIPULATOR

vaulted
0.15 mm diameter tip
overall length 109 mm



G-16160

JACOBI
LENS MANIPULATOR

vaulted
overall length 99 mm
for 0.3 mm IOL hole

G-16161

for 0.2 mm IOL hole



G-16166

SINSKEY

MARKING HOOK

diameter 0.2 mm, round tip
flat handle



G-16167

SINSKEY

LENS MANIPULATION HOOK

for 0.2 mm IOL hole
10 mm angled shaft
overall length 103 mm
round handle



G-32557

BREMEN MODEL

LENS MANIPULATOR

vertical Y-hook
0.15 mm diameter tip
overall length 116 mm



G-32555

RENTSCH

LENS MANIPULATOR AND HOOK

straight
0.18 mm diameter boat hook
overall length 137 mm



G-32530

FRANKFURT MODEL

MANIPULATOR

straight
0.18 mm diameter lens hook
overall length 137 mm



G-32275

ZIRM
LENS LOOP MANIPULATOR
vertical Y-hook
0.15 mm diameter tip
overall length 108 mm



G-32276

LESTER
LENS LOOP MANIPULATOR
vaulted
0.25 mm diameter tip
overall length 102 mm



G-16169

TAN DOGAN
EXPLANTATION HOOK
for IOL
0.2 mm diameter tip
overall length 103 mm



G-16210

HIRSCHMANN
LENS SPATULA
0.6 mm wide spatula with
0.2 mm notches
overall length 104 mm



G-16175

DARDENNE
IRIS HOOK AND LENS MANIPULATOR
push-pull tip
overall length 105 mm



G-32227

LUND

IRIS HOOK

0.8 mm collar button
overall length 105 mm

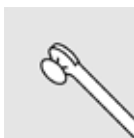

G-16205

BONN MODEL

IRIS HOOK

extra delicate
0.15 mm diameter hook
overall length 111 mm



G-31911

FRANKFURT MODEL

IRIS HOOK AND LENS MANIPULATOR

0.65 mm collar button
overall length 135 mm



G-16191

STEINMETZ

SPATULA

for manual lens fragmentation
1 mm wide nucleus bisector
for use in left hand
overall length 110 mm



G-16193

SPIRIG

SPATULA

for manual lens fragmentation
0.5 mm wide nucleus bisector
overall length 110 mm



G-32728

RENTSCH
SPATULA

12 mm long spatula
tapered from 0.6 mm to 0.3 mm
overall length 118 mm



G-32005

ENGELS
PHACO SPOON

0.6 mm wide round spatula
overall length 86 mm



G-32007

D. D. KOCH
PHACO SPATULA

curved with notches
duckbill 0.5mm wide tip
overall length 105 mm

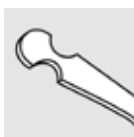

G-32523

AMON
PHACO SPATULA

paddle-shaped tip
0.8 mm wide x 1.6 mm long
0.2 mm thick
overall length 103 mm



G-16189

SPATULA

12 mm spatula
angled, 45°
overall length 108 mm

G-16190

0.5 mm wide x 0.25 mm thick
1.0 mm wide x 0.25 mm thick



G-32724

SEKUNDO
ENCLAVATION SPATULA
for retropupillary implantation of
Iris-Claw IOL
14 mm long spatula
tapered from 0.75 mm to 0.3 mm
overall length 118 mm



G-31378

ANIS
BALL CAPSULE POLISHER
1.5 mm diameter hemisphere tip
textured
overall length 113 mm



G-32563

RENTSCH
CAPSULE POLISHING CURETTE
angled 135°
1.5 mm diameter tip
anterior and posterior semi-sharp edges
overall length 108 mm



G-32564

RENTSCH
CAPSULE POLISHING CURETTE
angled 90°
1.5 mm diameter tip
anterior and posterior semi-sharp edges
overall length 110 mm



G-15620

ARLT
LENS LOOP
serrated, curved
3.5 mm wide
overall length 135 mm



G-15630

SNELLEN
LENS LOOP
smooth, curved
3.5 mm wide
overall length 135 mm



G-15640

WEBER
LENS LOOP
small
4 mm wide
overall length 130 mm



G-15645

WEBER
LENS LOOP
large
5 mm wide
overall length 135 mm



G-15635

SPIRIG
LENS LOOP
for manual lens fragmentation
serrated, curved
2.2 mm wide
overall length 135 mm





BANGERTER
SPATULA
lightly curved
overall length 139 mm
6 mm wide
10 mm wide
12 mm wide

G-15720
G-15725
G-15730



G-15731 *BEHRENS-BAUMANN*
ORBITAL SPATULA
with aspiration
10 mm wide, lightly curved
overall length 137 mm



SAUTTER
ORBITAL SPATULA
overall length 142 mm
22 x 13 mm curved plate
22 x 19 mm curved plate

G-15740
G-15750



G-32445 *HAMBURG MODEL*
ORBITAL SPATULA
18 x 12 mm curved plate
overall length 145 mm



G-32446 **ORBITAL SPATULA**
18 x 8 mm curved plate
overall length 145 mm



G-15758 **KERATOPLASTY SPATULA**
perforated



G-32727 *BINKHORST*
SYNECHIAE SPATULA
10 mm long, semi-sharp
extra delicate
overall length 129 mm



G-15477 *CASTROVIEJO*
SYNECHIAE SPATULA
7 mm long, semi-sharp
0.5 mm wide
overall length 86 mm

KERATOPLASTY · SYNECHIAE SPATULAS

12



G-15475 *CASTROVIEJO*
CYCLODIALYSIS SPATULA
double ended, blunt
10 and 15 mm long
overall length 134 mm



G-15470 *ELSCHMIG*
CYCLODIALYSIS SPATULA
10 mm long, blunt
1.2 mm wide
overall length 127 mm



G-15480 *CASTROVIEJO*
CYCLODIALYSIS SPATULA
10 mm long, blunt
0.7 mm wide
overall length 129 mm



G-15485 *CASTROVIEJO*
CYCLODIALYSIS SPATULA
15 mm long, blunt
0.7 mm wide
overall length 129 mm

G-15400

WECKER
IRIS SPATULA

slim
1.5 mm wide, lightly curved
overall length 129 mm



G-15405

WECKER
IRIS SPATULA

wide
2.5 mm wide, lightly curved
overall length 132 mm



G-31990

WECKER
IRIS SPATULA

conical
0.9 mm wide, lightly curved
overall length 134 mm



12

G-15390

FRANKFURT MODEL
IRIS SPATULA

0.9 mm wide, curved
overall length 125 mm



G-15391

FRANKFURT MODEL
IRIS SPATULA

extra delicate
0.25 mm wide, curved
overall length 125 mm



G-32729

IRIS SPATULA

extra delicate, conical
7 mm long spatula, angled
tapers from 0.5 mm to 0.3 mm
overall length 114 mm



G-31975

BANGERTER
IRIS SPATULA

round handle
8 mm long spatula, angled
overall length 118 mm

G-31980

1.0 mm wide

G-31985

1.5 mm wide

G-31985

2.0 mm wide



G-15360

BANGERTER
IRIS SPATULA

flat handle
8 mm long spatula, angled
overall length 125 mm

G-15365

1.0 mm wide

G-15370

1.5 mm wide

G-15370

2.0 mm wide



G-15755

ESSEN MODEL
SPATULA

10 mm wide
25 mm angled, flat
overall length 149 mm





G-15757 *GIESSEN MODEL*
SPATULA AND RETRACTOR
9 mm wide
angled, concave
overall length 162 mm



G-15780 *WELLS*
ENUCLEATION SPOON
overall length 147 mm



G-33912 *ZIRM*
LASIK CORNEAL PROTECTOR
7.0 x 2.5 mm corneal shield
overall length 120 mm



G-33930 *THOMAS NEUHANN*
LASIK SPATULA
with beveled blunt tip
rounded anterior and
flat posterior surface
for lifting the corneal flap
overall length 106 mm



G-33935

RAU

LASEK SPATULA

5.5 mm long spatula
for repositing and smoothing
the epithelial flap after laser ablation
overall length 116 mm



G-38607

DESCEMET INCISION HOOK

0.2 mm diameter blunt tip
for marking the area of Descemetorhexis
in recipient's eye
overall length 103 mm

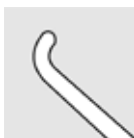

G-38608

DESCEMET SCRAPER

1 mm semi-circular tip
for scraping the recipient Descemet's
membrane
overall length 103 mm



G-38622

SZURMAN

DMEK PREPARATION SPATULA

disc-shaped spatula
2.5 mm diameter, blunt
for removal of Descemet's membrane from graft
overall length 121 mm

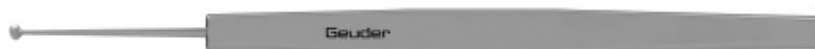

G-38604

THOMAS NEUHANN

ENDOTHELIAL INSERTION SPATULA

with teflon insert, angled 145°, 4 x 2 mm
for easy insertion of donor lamellar button
with notched tip for "pull-through" technique
overall length 104 mm
(used with G-38606)



G-33966

DICK

FEMTOCATARACT SPATULA

double ended with round semi-sharp tips
for easy opening of femto incisions
spatula 2.5 mm flattened, 0.65 mm wide
for main and sideport incisions
knife 90° angled, 0.9 mm wide
for arcuate incisions
overall length 100 mm



G-33967

BREYER

FEMTOCATARACT SPATULA

angled
1 mm blunt round tip
for opening femto incisions
overall length 100 mm

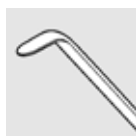

G-33968

HOFFMANN

**FEMTOCATARACT NUCLEUS ROTATOR
AND CHOPPER**

horizontal Y-shaped rotator, 0.75 mm wide
and 1 mm "Quick Chop" tip
overall length 120 mm



G-33950

CHANSUE

FEMTO DOUBLE INSTRUMENT

blunt spoon-shaped lenticule spatula
1.25 mm wide, vaulted and
hook, 2 mm long, angled
overall length 115 mm
to open the incision, delineate the edge
of the lenticules and separate the interfaces
during SMILE procedures

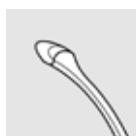

G-33952

CHANSUE

FEMTO DOUBLE INSTRUMENT

conical lenticule spatula, 9 mm long, vaulted
hook, 2 mm long, angled
overall length 115 mm

to open the incision, delineate the edge
of the lenticules and separate the interfaces
during SMILE procedures



G-33954

GUELL

FEMTO DOUBLE INSTRUMENT

1.25 mm wide spoon-shaped spatula,
lightly curved
2 mm long hook, angled
overall length 113 mm

to open the incision, delineate the edge
of the lenticules and separate the interfaces
during SMILE procedures

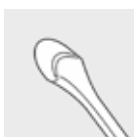
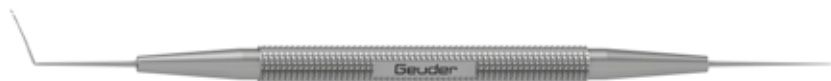

G-33940

BLUM

FEMTO-LASIK ROUND SPOON

spoon-shaped spatula, 1.25 mm wide
semi-sharp, bevel up, vaulted
overall length 105 mm

to undermine, lift and reposit LASIK flaps
created with a femtosecond laser



G-33942

BREYER

FEMTO-LASIK DOUBLE-ENDED INSTRUMENT

combination of
BLUM spoon-shaped spatula, semi-sharp
and hook with 1 mm inner edge
(one blunt and one slightly sharp edge)
overall length 115 mm



G-33427

PFAEFFL

FEMTO FLAP LIFTER

double ended, both ends blunt
10.5 mm conical v-shaped hook, curved and
1.5 mm modified *SINSKEY* hook
overall length 115 mm
for finding the flap edge, lifting, and retreating it



G-33943

PFAEFFL

FEMTO FLAP LIFTER

double ended
10.5 mm conical v-shaped hook, straight and
1.5 mm modified *SINSKEY* hook
overall length 115 mm
for finding the flap edge, lifting and retreating it



G-33958

PFAEFFL-BREYER

FEMTO FLAP LIFTER

double ended
10.5 mm conical v-shaped hook, curved
with double bevel tip and
1.5 mm modified *SINSKEY* hook
overall length 115 mm
for finding the flap edge, lifting and retreating it



G-33959

BREYER

FEMTO-LASIK HOOK INSTRUMENT

angled
1.3 mm wide scraper hook
to delineate and remove the lenticule
overall length 105 mm





G-33944

KOHNEN

FEMTO-LASIK DOUBLE-ENDED INSTRUMENT

11 mm long x 0.5 mm wide spatula and
2 mm modified *SINSKEY* hook, blunt tip
overall length 120 mm



G-19137

CUEPPERS

STRABISMUS MUSCLE TUCKER

15 mm scale, for muscle stretching
serrated J-shaped tendon hook to
prevent the muscle from slipping



G-32726

MUENSTER MODEL

SUTURE HOOK

hook 5 mm
overall length 149 mm



G-15799

GRAEFE
STRABISMUS HOOK
short, 5 mm
overall length 130 mm



G-15800

GRAEFE
STRABISMUS HOOK
small, 8 mm
overall length 131 mm



G-15805

GRAEFE
STRABISMUS HOOK
medium, 10 mm
overall length 133 mm



G-15810

GRAEFE
STRABISMUS HOOK
large, 12 mm
overall length 137 mm



G-32915

HAMBURG MODEL
STRABISMUS HOOK
10 mm long
slim 1 mm diameter hook
overall length 135 mm



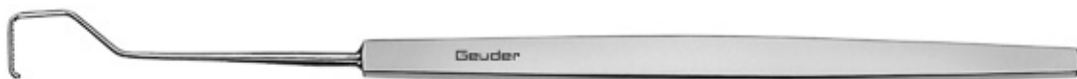

G-15830 *MALBRAN*
STRABISMUS HOOK
9.5 mm serrated hook with right-angle knob
to prevent muscle slippage
overall length 140 mm



G-15820 *BONN MODEL*
STRABISMUS HOOK
11 mm
overall length 143 mm



G-15821 *BONN MODEL*
STRABISMUS HOOK
11 mm retinal detachment hook
with 1.0 mm hole
overall length 143 mm



G-32905 *BONN MODEL*
STRABISMUS HOOK
curved, tenotomy hook
overall length 145 mm



G-32920 *JAMESON*
STRABISMUS HOOK
11 mm, with bulbous tip
overall length 125 mm



G-37435

HATTENBACH
HORSESHOE-HOOK
to pull the trocars off the lance
and to remove the trocars from the sclera
overall length 98 mm

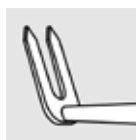

G-37551

BARTZ-SCHMIDT
ILM-SCRAPER
20 gauge / 0.9 mm
diamond dusted tip

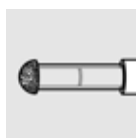

MEMBRANE SPATULAS

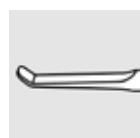

angled at 1.5 mm
G-37530 20 gauge / 0.9 mm

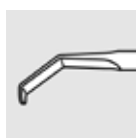

angled at 2 mm and 4 mm
G-37535 20 gauge / 0.9 mm



subretinal pick, angled at 4 mm
G-37545 20 gauge / 0.9 mm



LUCKE
curved
G-37515 20 gauge / 0.9 mm

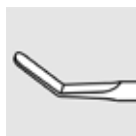

2.5 mm angled
G-37525 20 gauge / 0.9 mm



angled at 1 mm, long rakes
G-37570 20 gauge / 0.9 mm



with ball tip
angled at 2.0 mm
G-37550 20 gauge / 0.9 mm

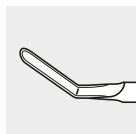

SPATULA KNIFE
all edges sharp
5.0 mm, angled
G-37560 20 gauge / 0.9 mm

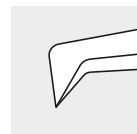

ZENONI
with pointed tip
G-37558 25 gauge / 0.5 mm

MEMBRANE SPATULAS

12



MEMBRANE PEELERS



1.0 mm angled
G-37500 20 gauge / 0.9 mm
G-37503 23 gauge / 0.6 mm



MORRIS-KROLL
1.5 angled
G-37505 20 gauge / 0.9 mm

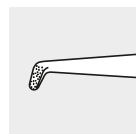

for MIS
textured, angled
G-37501 20 gauge / 0.9 mm



0.65 mm angled
black chromium
G-37506 20 gauge / 0.9 mm



0.4 mm, recessed, angled
black chromium
G-37511 20 gauge / 0.9 mm
G-37512 23 gauge / 0.6 mm
G-37513 25 gauge / 0.5 mm

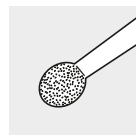

HEM-STOPPER
G-37549 20 gauge / 0.9 mm



G-37580

HANSEN
MICRO HOOK

to pass under retinal vessels
during arteriovenous dissection
20 gauge / 0.9 mm

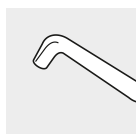

SCLERAL DEPRESSORS LOCALIZERS





G-32152 *LAQUA*
SCLERAL DEPRESSOR
with pocket clip
3 x 1.8 mm teardrop-shaped tip
overall length 128 mm



G-32150 *LAQUA*
SCLERAL DEPRESSOR
double-ended with pocket clip
3 x 1.8 mm teardrop-shaped tip
2 mm diameter scleral marker
overall length 134 mm



G-32153 *LUCKE*
SCLERAL DEPRESSOR
with pocket clip
3.8 x 2.0 mm teardrop-shaped tip
overall length 128 mm



G-32027 *KREISSIG*
SCLERAL DEPRESSOR
double-ended with pocket clip
conical tip with 2.4 mm diameter
and 6.0 mm bar
overall length 128 mm



G-15710 *MEYER-SCHWICKERATH*
LOCALIZER AND SCLERAL DEPRESSOR
 for fixation and rotation



G-32715 *SCHOCKET*
SCLERAL DEPRESSOR
 double-ended with pocket clip
 3 x 2 mm teardrop tip and
 6.0 mm bar
 overall length 132 mm



G-32714 **SCLERAL DEPRESSOR**
 double-ended
 2 mm and 4 mm diameter
 diamond dusted tips
 overall length 120 mm

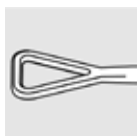

G-37445 *HATTENBACH*
TRIANGLE SCLERAL DEPRESSOR
 for gentle buckling and firm grip without the risk of rupture
 overall length 133 mm



G-33708 *FOERSTER*
FIXATION RING WITH SCLERAL DEPRESSOR
 inside diameter 6.5 mm

PROBES DILATORS



G-150301 *WILDER*
LACRIMAL PROBE
delicate, long taper
0.45 mm tip diameter
overall length 104 mm



G-150302 *WILDER*
LACRIMAL PROBE
medium, medium taper
0.50 mm tip diameter
overall length 104 mm



G-150303 *WILDER*
LACRIMAL PROBE
strong, short taper
0.55 mm tip diameter
overall length 104 mm



G-150401 *WILDER*
LACRIMAL PROBE
slim
delicate, long taper
0.30 mm tip diameter
overall length 95 mm



G-150402 *WILDER*
LACRIMAL PROBE
slim
medium, medium taper
0.35 mm tip diameter
overall length 95 mm



G-150403 *WILDER*
LACRIMAL PROBE
slim
strong, short taper
0.40 mm tip diameter
overall length 95 mm



G-15020 *GIESSEN MODEL*
LACRIMAL PROBE
11 mm tapered shaft, angled
0.4 mm tip width
overall length 77 mm



KELLNAR

RETROGRADE PROBE

for canalicular repair
0.5 mm suture hole
overall length 95 mm

G-15050

right

G-15055

left



G-15095

PIGTAIL PROBE

double-ended
for canalicular repair
with 0.4 mm suture holes
overall length 140 mm



G-15096

PIGTAIL PROBE

double-ended
for canalicular repair
with 1.0 mm suture hooks
overall length 140 mm



LACRIMAL PROBES · CORNEAL IMPLANT PROBES

14

G-37602

PROBE FOR STROMAL CHANNEL

for corneal implants in patients with
keratoconus
overall length 115 mm

G-37604

bent to the left

bent to the right





BOWMAN
LACRIMAL PROBE
cylindrical, silver
overall length 130 mm
size 0000/000
size 00/0
size 1/2
size 3/4
size 5/6

- G-150001**
- G-150002**
- G-150003**
- G-150004**
- G-150005**



BOWMAN
LACRIMAL PROBE
cylindrical, stainless steel
overall length 130 mm
size 0000/000
size 00/0
size 1/2
size 3/4
size 5/6

- G-150101**
- G-150102**
- G-150103**
- G-150104**
- G-150105**



BOWMAN
LACRIMAL PROBE
bulbous tips, silver
overall length 130 mm
size 0000/000
size 00/0
size 1/2
size 3/4
size 5/6

- G-150051**
- G-150052**
- G-150053**
- G-150054**
- G-150055**



BOWMAN
LACRIMAL PROBE
bulbous tips, stainless steel
overall length 130 mm
size 0000/000
size 00/0
size 1/2
size 3/4
size 5/6

- G-150151**
- G-150152**
- G-150153**
- G-150154**
- G-150155**

JUENEMANN

LACRIMAL PROBE

with 72 mm probe and 18 mm grip plate
to insert suture material
provided with cleaning adaptor G-31022

G-33193

0.6 mm diameter

G-33194

0.8 mm diameter

G-33195

1.0 mm diameter

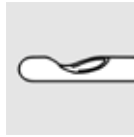

G-15315

KRUMEICH

DALK PROBE

for deep lamellar keratoplasty

12 mm tapered probe

overall length 73 mm



MACKENSEN

TRABECULAR PROBE

7 mm curved probe

overall length 92 mm

G-15105

right

G-15110

left



HARMS

TRABECULAR PROBE

dual 9.5 mm curved probes

3 mm spread

overall length 46 mm

G-15125

right

G-15130

left



THOMAS NEUHANN

U-SHAPED PROBE

with holding plate

dual 9 mm curved probes

3 mm spread

overall length 12 mm

G-15136

0.30 mm probe diameter

G-15138

0.25 mm probe diameter



G-15137

THOMAS NEUHANN

HOLDER

with lock

for U-shaped probes G-15136 and G-15138

overall length 92 mm



TRABECULAR PROBES · U-SHAPED PROBE · LACRIMAL PROBES



CANNULAS I/A INSTRUMENTS



LACRIMAL.....	191
ANTERIOR CHAMBER MAINTAINERS.....	193
HYDRODISSECTION · CYCLODIALYSIS.....	194
IRRIGATION VECTIS.....	195
VISCOELASTIC · IRRIGATION/ASPIRATION.....	196
IRRIGATION/ASPIRATION · CAPSULE POLISHERS.....	197
CAPSULER POLISHERS · LASIK.....	198
BIMANUAL IRRIGATION/ASPIRATION.....	200
COAXIAL IRRIGATION/ASPIRATION · DMEK IRRIGATION.....	205
RETINAL · BACKFLUSH.....	208
RETINAL · INFUSION · INJECTION · ASPIRATION.....	211
MISCELLANEOUS.....	214

LACRIMAL CANNULA
conical, straight
tapers from 19 to 25 gauge
25 mm shaft
silver
stainless steel

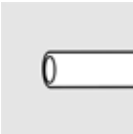
G-33140
G-33135

LACRIMAL CANNULA
conical, strongly curved
tapers from 19 to 25 gauge
25 mm shaft
silver
stainless steel

G-15140
G-15141



LACRIMAL CANNULA
conical, angled at 10 mm
tapers from 19 to 25 gauge
25 mm shaft
silver
stainless steel

G-15150
G-15151





LACRIMAL CANNULA
conical, angled at 18 mm
tapers from 19 to 25 gauge
25 mm shaft
silver
stainless steel

G-15160
G-15161



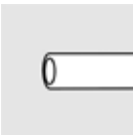

ANEL
LACRIMAL CANNULA
straight
15 mm shaft
23 gauge / 0.64 mm

G-15190



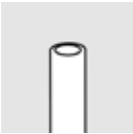

ANEL
LACRIMAL CANNULA
strongly curved
16 mm shaft
23 gauge / 0.64 mm

G-15195

- LACRIMAL CANNULA**
 cylindrical, straight
- G-33160** 20 gauge / 0.9 x 35 mm
 - G-33170** no. 12, 0.72 x 32 mm
 - G-33175** no. 14, 0.67 x 30 mm
 - G-33180** no. 16, 0.60 x 22 mm
 - G-33185** no. 18, 0.45 x 22 mm
 - G-33190** no. 20, 0.42 x 22 mm

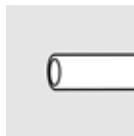

- G-15170** *BONN MODEL*
LACRIMAL CANNULA
 with probe tip
 1.15 mm diameter olive tip

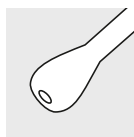

- BANGERTER*
LACRIMAL PROBE CANNULA
 straight, 0.6 mm side port
- G-15271** 23 gauge / 0.64 x 60 mm
 - G-15272** 21 gauge / 0.80 x 40 mm
 - G-15273** 23 gauge / 0.64 x 40 mm

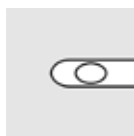

- G-33197** *JUENEMANN*
LACRIMAL PROBE CANNULA
 to insert suture material
 21 gauge / 0.8 x 35 mm





- G-33198** *JUENEMANN*
LACRIMAL PROBE CANNULA
 with grip plate
 65 mm probe
 to insert suture material
 21 gauge / 0.8 x 65 mm



G-15375 **RETROBULBAR INJECTION CANNULA**
G-32605 24 gauge / 0.6 x 60 mm
G-32600 24 gauge / 0.6 x 35 mm
G-15376 25 gauge / 0.5 x 35 mm
G-15377 25 gauge / 0.5 x 50 mm

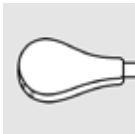

G-15200 *CRANZ*
EYE DOUCHE
 irrigation through five front ports
 silver

G-33416 *BOPP*
ANTERIOR CHAMBER INFUSION CANNULA
 anterior chamber maintainer with
 threaded tip for better fixation
 and silicone tube
 20 gauge / 0.9 mm





G-33422 *BONN MODEL*
ANTERIOR CHAMBER INFUSION CANNULA
 self-retaining textured tip
 dual 0.35 mm side ports
 silicone tube 15 cm
 23 gauge / 0.6 mm



G-16105 **IRRIGATION CYSTOTOME CANNULA**
 26 gauge / 0.45 mm

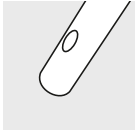

G-15220 **ENZYME CANNULA**
 24 gauge / 0.6 mm

RETROBULBAR · EYE DOUCHE · A.C. MAINTAINERS · CYSTOTOMES · ENZYME

G-15275 CYCLODIALYSIS SPATULA CANNULA

12 mm long spatula
anterior 0.2 mm port
26 gauge / 0.45 mm



G-31355 BUSSE CYCLODIALYSIS SPATULA CANNULA

12 mm long spatula
dual 0.2 mm port
26 gauge / 0.45 mm



G-15250 G-32166 G-32167 SAUTTER HYDRODISSECTION CANNULA

front opening
flattened tip
vertical, 27 gauge / 0.4 mm
vertical, 26 gauge / 0.45 mm
horizontal, 27 gauge / 0.4 mm

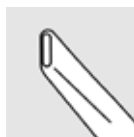

vertical
G-15250
G-32166

horizontal
G-32167



G-32155 TUEBINGEN MODEL HYDRODISSECTION CANNULA

30 gauge / 0.3 mm



G-15185 FRANKFURT MODEL HYDRODISSECTION CANNULA

27 gauge / 0.4 mm

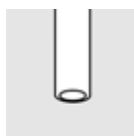

G-31895 HYDRODISSECTION CANNULA

vertically flattened tip
front opening
24 gauge / 0.6 x 20 mm



G-15252 G-15253 SPIRIG HYDRODISSECTION CANNULA

for manual lens fragmentation
right
left



HYDRODISSECTION · CYCLODIALYSIS

G-16115 IRRIGATION VECTIS CANNULA

4 front ports
5 mm wide lens loop
curved

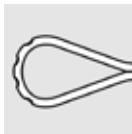

G-32759 IRRIGATION VECTIS CANNULA

small model
4 front ports
4 mm wide lens loop
curved

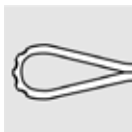

G-31510 KLÖCKNER EXPRESSOR CANNULA

8 mm wide lens loop
4 front ports
lightly curved



G-31807 HEALON - VISCOELASTIC CANNULA

flattened tip, angled at 6 mm
30 mm shaft
21 gauge / 0.8 mm



G-22619 PH. JACOBI TRABECULAR ASPIRATION CANNULA

angled at 13 mm
24 gauge / 0.6 mm



G-15188 G-15189 BURK IRRIGATION TRABECULOTOMY CANNULA

8 mm curved irrigation probe
30 gauge / 0.3 mm
angled right
angled left



G-33199 NAGATA SUB-TENON INJECTION CANNULA

for atraumatic penetration and
injection of anesthetic agent
24 gauge / 0.6 mm



G-15180 **IRRIGATION CANNULA**
 bulbous tip, 0.75 mm diameter tip
 extra delicate
 26 gauge / 0.45 mm



G-15230 *BONN MODEL*
IRRIGATION CANNULA
 flattened tip, front opening
 delicate, 0.5 x 1.5 mm
G-15240 medium, 0.6 x 1.9 mm



G-16135 *BINKHORST*
IRRIGATION CANNULA
 U-shaped
 22 gauge / 0.7 mm x 36 mm
 angled right
G-16136 angled left



G-32760 *MUELLER*
IRRIGATION CANNULA
 J-shaped with probe tip
 26 gauge / 0.45 x 19 mm
 angled left
G-32765 angled right









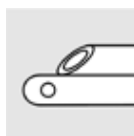

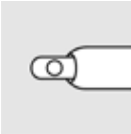

G-16138 *RENTSCH*
IRRIGATION CANNULA
 J-shaped
 angled at 10 mm
 26 gauge / 0.45 x 24 mm



G-16106 *SIMCOE*
IRRIGATION / ASPIRATION CANNULA
 dual shaft
 0.3 mm diameter aspiration port
 front opening irrigation port
 23 gauge / 0.64 mm
 with silicone tube and Luer-Lock hub



G-16120	<p>IRRIGATION / ASPIRATION CANNULA COAXIAL straight aspiration port 0.4 mm infusion tube 18 gauge / 1.2 mm</p>		
G-15225 G-15226	<p>ASPIRATION CANNULA lightly curved, front opening delicate, 19 gauge / 1.1 mm standard, 17 gauge / 1.5 mm</p>		
G-16125	<p><i>KRATZ</i> CAPSULE POLISHING CANNULA angled at 2 mm half-textured tip 23 gauge / 0.64 mm</p>		
G-16133	<p><i>TEPING</i> ASPIRATION POLISHING CANNULA 0.3 mm posterior port half-textured tip, curved 23 gauge / 0.64 mm</p>		
G-16130	<p>CAPSULE POLISHING CANNULA with half-textured ball tip 18 gauge / 1.2 mm</p>		
G-16132	<p><i>PAPST</i> CAPSULE POLISHING CANNULA 0.75 mm hemisphere textured tip 25 gauge / 0.5 mm</p>		
G-32529 G-32527	<p><i>KYU</i> CAPSULE POLISHING CANNULA 2 mm disc-shaped tip textured 22 gauge / 0.7 mm 23 gauge / 0.64 mm</p>		

G-32528

GREITE
CAPSULE POLISHING CANNULA
 curette tip
 textured
 22 gauge / 0.7 mm



G-32774

BRAUWEILER
ASPIRATION CANNULA
 angled at 13 mm
 textured polisher tip
 0.3 mm beveled port
 21 gauge / 0.8 mm



G-32769

H.-R. KOCH
ASPIRATION CANNULA
 angled at 14 mm
 0.3 mm anterior port
 half-textured, spatulated tip
 21 gauge / 0.8 mm



G-32776

BRAUWEILER
IRRIGATION CANNULA
 angled at 12 mm
 front opening
 21 gauge / 0.8 mm



G-32772

BRAUWEILER
IRRIGATION CANNULA
 angled at 13 mm
 textured 0.8 mm iris retractor and
 capsule polisher
 21 gauge / 0.8 mm



G-33909

W. BAUER
LASIK CANNULA
 double-armed
 6 ports
 for irrigation of the flap and stromal bed
 25 gauge / 0.5 mm

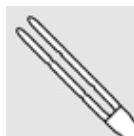

CAPSULER POLISHERS · LASIK

15

G-33910 *ZIRM*
LASIK DISSECTOR CANNULA
flattened
front opening
25 gauge / 0.5 mm



G-33911 *ZIRM*
LASIK IRRIGATION CANNULA
flattened and textured tip
with 5 irrigation ports
20 gauge / 0.9 mm



G-15310 *KRUMEICH*
CORNEAL IRRIGATION CANNULA
for big bubble technique during DALK
semi-sharp dissector tip
0.2 mm posterior port
27 gauge / 0.4 mm



G-15312 *KRUMEICH*
CORNEAL IRRIGATION CANNULA
for big bubble technique during DALK
angled at 12 mm
0.4 mm anterior port
23 gauge / 0.6 mm



G-22550 **IRRIGATION CANNULA HANDPIECE**
overall length 115 mm



G-32015 **IRRIGATION CANNULA HANDPIECE**
male / female connectors
overall length 112 mm

G-32771 *BRAUWEILER*
IRRIGATION CANNULA HANDPIECE
 male / female connectors
 78 mm



G-32773 *BRAUWEILER*
ASPIRATION CANNULA HANDPIECE
 male / male connectors
 80 mm



G-32778 *KEERL*
IRRIGATION CANNULA HANDPIECE
 with silicone tube



G-32010 **IRRIGATION CANNULA HANDPIECE**
 with silicone tube



SCHMACK
 21 gauge / 0.8 mm



G-22632 **IRRIGATION HANDPIECE**
 0.5 mm port

G-22633 **ASPIRATION HANDPIECE**
 0.3 mm port



D.D. KOCH - KOHNEN
ASPIRATION HANDPIECE
 0.3 mm aspiration port
 textured tip



G-22100 22 gauge / 0.7 mm
G-22102 23 gauge / 0.6 mm

G-22101

D.D. KOCH - KOHNEN
IRRIGATION HANDPIECE
front opening
22 gauge / 0.7 mm



G-22105
G-22106

ASPIRATION HANDPIECE
0.25 mm aspiration port
conical tip
oval tube 0.95 x 0.55 mm
smooth
textured

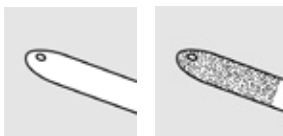

G-22107

IRRIGATION HANDPIECE
0.5 mm irrigation port
conical tip
oval tube 0.95 x 0.55 mm

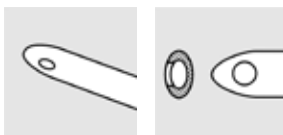

G-22637

SCHMACK
ASPIRATION HANDPIECE
4 x 0.15 mm posterior ports
textured tip
23 gauge / 0.6 mm



G-32011 ASPIRATION HANDPIECE

0.3 mm aspiration port
textured, conical tip
21 gauge / 0.8 mm



G-32012 IRRIGATION HANDPIECE

dual 0.5 mm irrigation ports
textured, conical tip
21 gauge / 0.8 mm



G-32018 BRAUWEILER ASPIRATION HANDPIECE

angled at 13 mm
0.3 mm beveled port
textured tip
21 gauge / 0.8 mm



G-32019 H.-R. KOCH ASPIRATION HANDPIECE

angled at 14 mm
0.3 mm anterior port
half-textured, spatulated tip
21 gauge / 0.8 mm



G-32016 *BRAUWEILER*
IRRIGATION HANDPIECE
angled at 12 mm
front opening
21 gauge / 0.8 mm



G-32017 *BRAUWEILER*
IRRIGATION HANDPIECE
angled at 13 mm
textured 0.8 mm iris retractor and
capsule polisher
21 gauge / 0.8 mm



G-32026 *R. KOCH*
ASPIRATION HANDPIECE
0.3 mm aspiration port
textured tip
19 gauge / 1.1 mm



G-32028 *R. KOCH*
IRRIGATION HANDPIECE
angled
dual 0.75 mm side ports
19 gauge / 1.1 mm



G-32014

R. KOCH

IRRIGATION CHOPPER

angled
dual 0.75 mm side ports
1 mm angled chopper tip
19 gauge / 1.1 mm



G-32059

DICK

IRRIGATION CHOPPER

angled
dual 0.75 mm side ports
1 mm curved chopper tip
19 gauge / 1.1 mm



G-38601

ALTHAUS / CARTSBURG

IRRIGATION DESCMET HOOK

hook diameter: 0.25 mm
hook length: 0.6 mm
for Descemetorhexis
rhombic 0.9 x 0.6 mm irrigation tube
overall length 98 mm



G-38602

THOMAS NEUHANN

IRRIGATION DESCMET SCRAPER

scraper width: 0.8 mm
scraper length: 0.6 mm
rhombic 0.9 x 0.6 mm irrigation tube
for peripheral scraping of the recipient bed
overall length 94 mm



G-38631

SZURMAN
DMEK IRRIGATION HANDPIECE
curved, closed tip
side port 0.3 mm
tube 23 gauge / 0.6 mm



G-38632

SZURMAN
DMEK IRRIGATION HANDPIECE
curved, front opening
tube 23 gauge / 0.6 mm

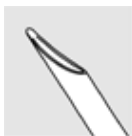

PEP 2.2 MM I/A HANDPIECE
Pure Efficiency Phaco
for 2.2 mm incisions
0.3 mm aspiration port
coaxial I/A straight tip
G-24318
G-24418
coaxial I/A 30° angled tip

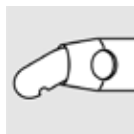
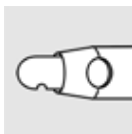

straight
G-24318

angled
G-24418

with G-24311 PEP infusion sleeve

G-24311

PEP 2.2 MM INFUSION SLEEVE
Pure Efficiency Phaco
for 2.2 mm incisions
purple translucent silicone

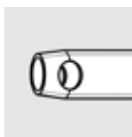



PEP 2.4 MM I/A HANDPIECE

Pure Efficiency Phaco
for 2.4 mm incisions
0.3 mm aspiration port
coaxial I/A straight tip
coaxial I/A 30° angled tip

G-24332
G-24432

with G-24314 PEP infusion sleeve

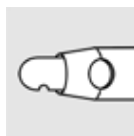

straight
G-24332

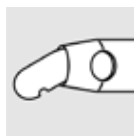

angled
G-24432

G-24314

PEP 2.4 MM INFUSION SLEEVE

Pure Efficiency Phaco
for 2.4 mm incisions
green translucent silicone

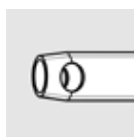

G-24330

I/A HANDPIECE

coaxial straight tip
0.3 mm aspiration port
with G-24100 infusion sleeve

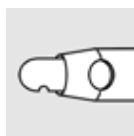

G-24430
G-24435
G-24440

I/A HANDPIECE

coaxial 30° angled tip
0.3 mm aspiration port
0.35 mm aspiration port
0.4 mm aspiration port

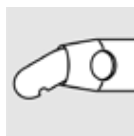

with G-24100 infusion sleeve



COAXIAL IRRIGATION/ASPIRATION

G-24100 **INFUSION SLEEVE**
blue silicone
for I/A handpieces

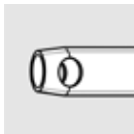

G-22525
G-22527
G-22540
G-22542

PAPST
I/A HANDPIECE
coaxial
infusion tube 16 gauge / 1.6 mm
aspiration port 0.3 mm, straight
aspiration port 0.4 mm, straight
aspiration port 0.3 mm, angled 30°
aspiration port 0.4 mm, angled 30°

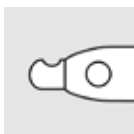

straight
G-22525
G-22527

angled
G-22540
G-22542



G-22615

PAPST
I/A HANDPIECE
coaxial 30° angled tip
aspiration port 0.3 mm
infusion tube 18 gauge / 1.3 mm



G-22556

HUNOLD
I/A HANDPIECE
coaxial, curved
aspiration port 0.3 mm
infusion tube 18 gauge / 1.3 mm



G-33045 BACKFLUSH HANDPIECE

with Luer cone
overall length 110 mm



G-31805 BACKFLUSH HANDPIECE

with silicone chamber and Luer cone
overall length 110 mm



G-37002 BACKFLUSH HANDPIECE

with silicone chamber and Luer-Lock connector
overall length 115 mm



G-37000 BACKFLUSH HANDPIECE

with silicone chamber and chuck
overall length 110 mm



for backflush tips G-37010 up to G-37080

SILICONE CHAMBER

for backflush handpieces
G-31805, G-37000, G-37002



G-31806

reusable

G-34806

single use, 10 pcs. per box, sterile

G-37005 BACKFLUSH HANDPIECE

with large silicone chamber
rotatable chuck





for backflush cannulas G-37010 up to G-37080



G-37006 SILICONE CHAMBER

large, for backflush handpiece G-37005

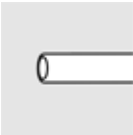

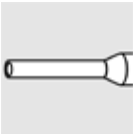

RETINAL · BACKFLUSH HANDPIECES

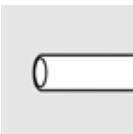

<p>G-33050 G-33054 G-33053</p>	<p>BACKFLUSH CANNULA 35 mm shaft 20 gauge / 0.9 mm 23 gauge / 0.6 mm 25 gauge / 0.5 mm</p>		
---	---	---	---

<p>G-33070</p>	<p>BACKFLUSH CANNULA 35 mm shaft 20 gauge / 0.9 mm shaft 25 gauge / 0.5 mm tip 3.5 mm tapered tip</p>		
-----------------------	--	---	---

<p>G-33071</p>	<p>BACKFLUSH CANNULA 35 mm shaft 0.5 mm side port 20 gauge / 0.9 mm</p>		
-----------------------	--	---	---

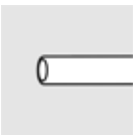
<p>G-33072</p>	<p><i>LAQUA</i> BACKFLUSH CANNULA 35 mm shaft inside diameter: 21 gauge / 0.8 mm outside diameter: 19 gauge / 1.1 mm</p>		
-----------------------	---	---	---

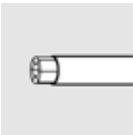
<p>G-33073</p>	<p><i>KAMPIK</i> BACKFLUSH CANNULA 35 mm shaft inside diameter: 22 gauge / 0.7 mm outside diameter: 20 gauge / 0.9 mm</p>		
-----------------------	--	---	---

<p>G-33075</p>	<p>BACKFLUSH CANNULA 35 mm shaft 0.8 mm silicone brush 20 gauge / 0.9 mm</p>		
-----------------------	---	---	---

<p>G-33077</p>	<p>BACKFLUSH CANNULA 20 gauge / 0.9 mm shaft 24 gauge / 0.55 mm tip 7 mm tapered tip, angled at 3.5 mm</p>		
-----------------------	---	---	---

G-37010 **BACKFLUSH TIP**
 35 mm shaft
 20 gauge / 0.9 mm

G-37011
 23 gauge / 0.6 mm

G-37012
 25 gauge / 0.5 mm



G-37015 **BACKFLUSH TIP**
 35 mm shaft
 angled at 3 mm
 20 gauge / 0.9 mm



G-37020 **BACKFLUSH TIP**
 35 mm shaft
 0.8 mm silicone brush
 20 gauge / 0.9 mm

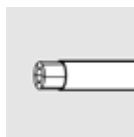

G-37025 **BACKFLUSH TIP**
 35 mm shaft
 angled at 6 mm
 0.8 mm silicone brush
 20 gauge / 0.9 mm

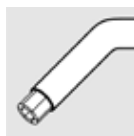

G-37035 **BACKFLUSH TIP**
 35 mm shaft
 0.8 mm silicone tip
 20 gauge / 0.9 mm

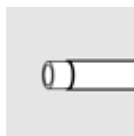

G-37046 *KLEIN*
BACKFLUSH TIP
 20 gauge / 0.9 mm shaft
 26 gauge / 0.45 mm tip
 2 mm tapered tip
 overall length 35 mm

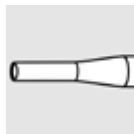

G-37065 **BACKFLUSH TIP**
 35 mm shaft
 20 gauge / 0.9 mm shaft
 30 gauge / 0.3 mm tip
 tapered tip, angled at 5 mm
 oval aspiration port



G-37080

BACKFLUSH TIP

35 mm shaft
20 gauge / 0.9 mm shaft
23 gauge / 0.6 mm tip
2 mm tapered tip
overall length 35 mm

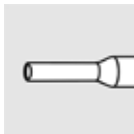

G-33420

INFUSION CANNULA

silicone tube 40 cm
Luer-Lock metal adapter
20 gauge / 0.9 mm
beveled, 4.0 mm (single-use G-33463)
G-33425 beveled, 5.0 mm
G-33430 beveled, 6.0 mm
G-33433 beveled, 7.0 mm

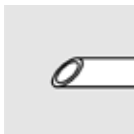

G-33450

INFUSION CANNULA

silicone tube 40 cm
Luer-Lock plastic adapter
20 gauge / 0.9 mm
beveled, 4.0 mm
G-33451 beveled, 5.0 mm
G-33452 beveled, 6.0 mm

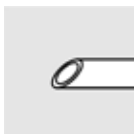

G-33484

INJECTION CANNULA

for viscous fluids, without silicone tube
for butterfly-19 cannula
20 gauge / 0.9 mm
beveled, 4.0 mm
G-33485 beveled, 5.0 mm
G-33486 beveled, 6.0 mm

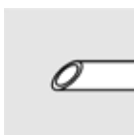

G-33494

INJECTION CANNULA

for viscous fluids, without silicone tube
for butterfly-21 cannula
20 gauge / 0.9 mm
beveled, 4.0 mm
G-33495 beveled, 5.0 mm

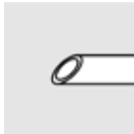

G-32180

DUISBURG MODEL
INJECTION CANNULA

for viscous fluids
25 cm silicone tube with 2 metal sleeves
and Luer-Lock adapter
20 gauge / 0.9 mm
beveled, 4.0 mm
G-32181 beveled, 5.0 mm
G-32182 beveled, 6.0 mm

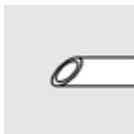

HAMBURG MODEL

INJECTION CANNULA

for viscous fluids
25 cm silicone tube with metal sleeve
and Luer-Lock adapter
3 spare silicone tubes

- G-33470** 20 gauge / 0.9 mm, beveled, 4.0 mm
- G-33471** 20 gauge / 0.9 mm, beveled, 5.0 mm
- G-33472** 20 gauge / 0.9 mm, beveled, 6.0 mm
- G-33473** 23 gauge / 0.6 mm, beveled, 4.0 mm
- G-33474** 23 gauge / 0.6 mm, beveled, 6.0 mm

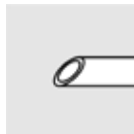

G-33475 SPARE SILICONE TUBE

for injection cannulas
25 cm
3 pcs. per box



WEBER

ASPIRATION CANNULA

for viscous fluids
inside diameter: 22 gauge / 0.7 mm
outside diameter: 20 gauge / 0.9 mm

- G-33051** 5 mm shaft
- G-33052** 10 mm shaft

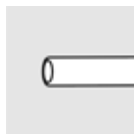

G-37390 ASPIRATION CANNULA

23 gauge / 0.6 mm
10 mm shaft

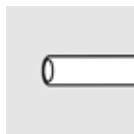

G-33056 ROIDER ASPIRATION CANNULA

for viscous fluids
0.7 mm side port
19 gauge / 1.0 mm



G-33055 PFCL CANNULA

with dual shaft
24 gauge / 0.55 mm
25 gauge / 0.5 mm, lateral tube

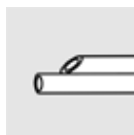

G-33057 CHANG PFCL CANNULA

for injection of heavy fluids
dual bore, coaxial
25 gauge / 0.5 mm tip
20 gauge / 0.9 mm shaft

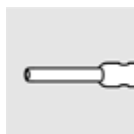

HEIDELBERG MODEL

CANNULA

for injection or aspiration of viscous fluids and Densiron[®] 68, bevel 30°

G-32699

19 gauge / 1.1 mm

G-32698

18 gauge / 1.2 mm

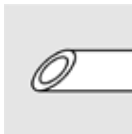

G-33059

BARTZ-SCHMIDT

CANNULA

for retinal detachment, coaxial, probe tip 0.9 mm, outside diameter of inner tube: 25 gauge / 0.5 mm, 20 gauge / 0.9 mm

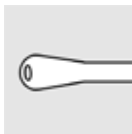

STOPPER

for viscous fluid aspiration with tube connection for single-use syringe

G-33060

for 5 ml syringe

G-33065

for 10 ml syringe

G-33066

for 20 ml syringe



G-32697

PRESSURE TUBE

for injection of viscous fluids Luer-Lock female / male reusable



G-32696

SINGLE-USE PRESSURE TUBE

for injection of viscous fluid, Luer-Lock female / male 10 pcs. per box, sterile



G-30745

PRESSURE CONNECTION TUBE

for MEGATRON S3 / S4 HPS for holder G-28750 and G-28764 for pneumatic silicone oil injection length 2 m

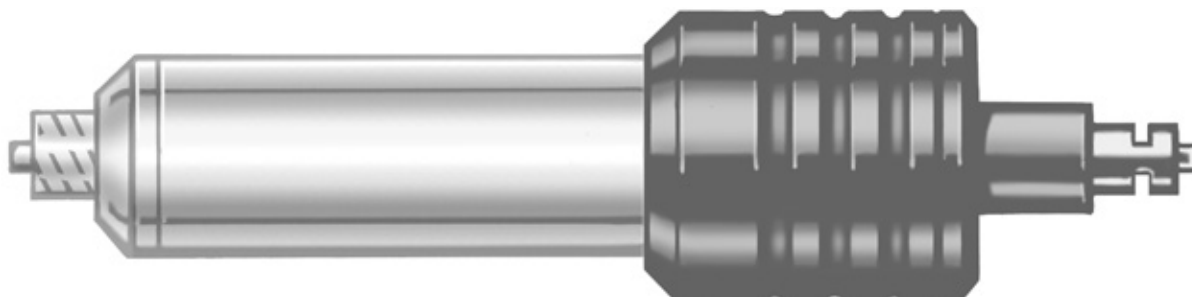

G-28764 ADAPTER
with protective cover for glass syringes
to inject viscous fluid pneumatically

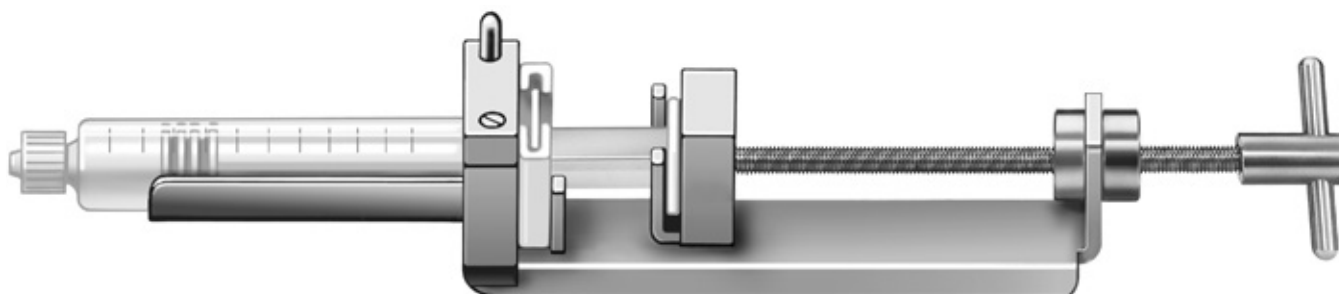

G-28752 SYRINGE HOLDER
for manual injection of
viscous fluids in glass syringes,
with clamp and retraction mechanism

SYRINGE CLIP
customized labeling

- G-19960** for 2 ml syringes
- G-19961** for 5 ml syringes



SILICONE BULB
with Luer cone

- G-32665** 20 ml
- G-32670** 60 ml



MISCELLANEOUS

15

SINGLE USE INSTRUMENTS



NANOEDGE TREPHINES AND PUNCHES.....	217
NANOEDGE SURGICAL KNIVES.....	219
UNO COLORLINE (SCISSORS · FORCEPS · PROBES · TROCARS · FIBER OPTICS · VITREOUS CUTTERS).....	221
DMEK CARTRIDGE · IRIS RETRACTORS · LACRIMAL INTUBATION.....	227
CANNULAS (LACRIMAL, RETROBULBAR, CYSTOTOME, A.C. MAINTAINER).....	228
BIMANUAL I/A HANDPIECE · BACKFLUSH.....	231
CANNULAS (INFUSION, INJECTION).....	232
INJECTION SYRINGES · OIL INJECTION.....	234
CAUTERY · ABSORBENT SWABS · MARKING PEN.....	236
SILICONE IMPLANTS FOR SCLERAL BUCKLING.....	237
IVOM INJECTION SET.....	243

NANOEDGE TREPHINES

length 16 mm
sterile, single-use

G-520400	4.00 mm	G-520825	8.25 mm	G-521350	13.50 mm
G-520500	5.00 mm	G-520850	8.50 mm	G-521400	14.00 mm
G-520550	5.50 mm	G-520875	8.75 mm	G-521450	14.50 mm
G-520600	6.00 mm	G-520900	9.00 mm	G-521500	15.00 mm
G-520625	6.25 mm	G-520950	9.50 mm	G-521550	15.50 mm
G-520650	6.50 mm	G-521000	10.00 mm	G-521600	16.00 mm
G-520675	6.75 mm	G-521050	10.50 mm	G-521650	16.50 mm
G-520700	7.00 mm	G-521100	11.00 mm	G-521700	17.00 mm
G-520725	7.25 mm	G-521150	11.50 mm	G-521800	18.00 mm
G-520750	7.50 mm	G-521200	12.00 mm		
G-520775	7.75 mm	G-521250	12.50 mm		
G-520800	8.00 mm	G-521300	13.00 mm		



G-500001 NANOEDGE SINGLE-USE CORNEAL CUTTING BLOCK

Teflon, sterile
white-colored
outside diameter 18.8 mm
height 9.5 mm



NANOEDGE TREPHINE PUNCHES

sterile, single-use

G-540600	6.00 mm	G-540725	7.25 mm	G-540850	8.50 mm
G-540625	6.25 mm	G-540750	7.50 mm	G-540875	8.75 mm
G-540650	6.50 mm	G-540775	7.75 mm	G-540900	9.00 mm
G-540675	6.75 mm	G-540800	8.00 mm	G-540925	9.25 mm
G-540700	7.00 mm	G-540825	8.25 mm	G-540950	9.50 mm

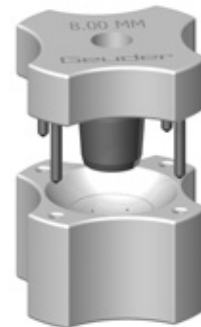

NANOEDGE VACUUM TREPHINE PUNCHES

sterile, single-use

G-560600	6.00 mm	G-560725	7.25 mm	G-560850	8.50 mm
G-560625	6.25 mm	G-560750	7.50 mm	G-560875	8.75 mm
G-560650	6.50 mm	G-560775	7.75 mm	G-560900	9.00 mm
G-560675	6.75 mm	G-560800	8.00 mm	G-560925	9.25 mm
G-560700	7.00 mm	G-560825	8.25 mm	G-560950	9.50 mm

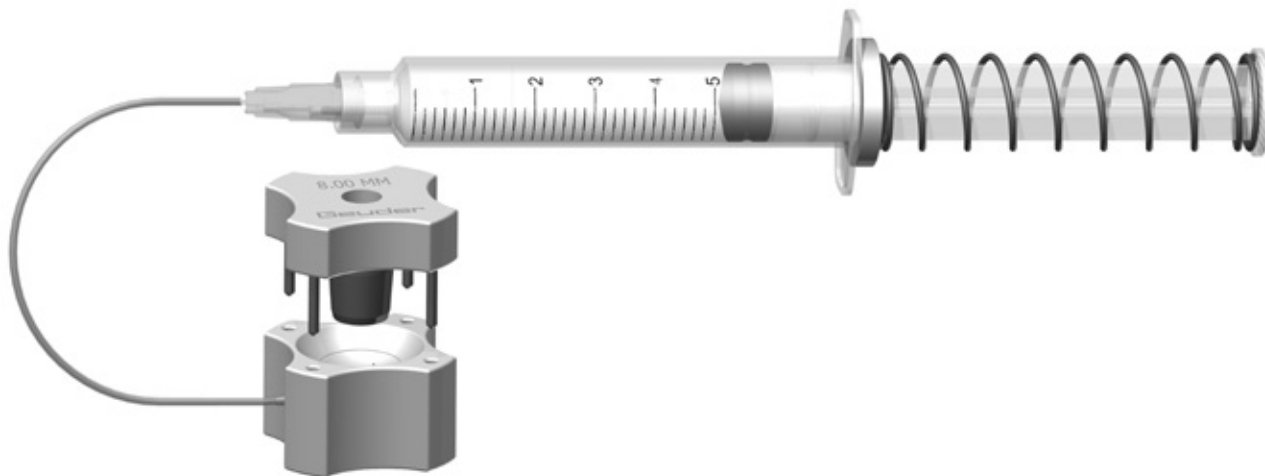

NANOEDGE VACUUM TREPHINE radial

sterile, single-use

G-570600	6.00 mm	G-570750	7.50 mm	G-570850	8.50 mm
G-570650	6.50 mm	G-570775	7.75 mm	G-570875	8.75 mm
G-570700	7.00 mm	G-570800	8.00 mm	G-570900	9.00 mm
G-570725	7.25 mm	G-570825	8.25 mm		

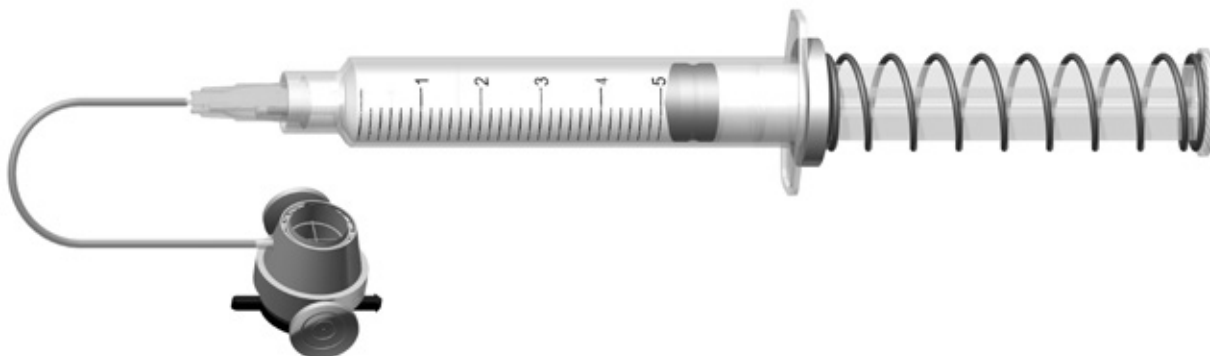

SINGLE-USE KNIVES FOR OPHTHALMIC SURGERY

6 pcs. per box
sterile

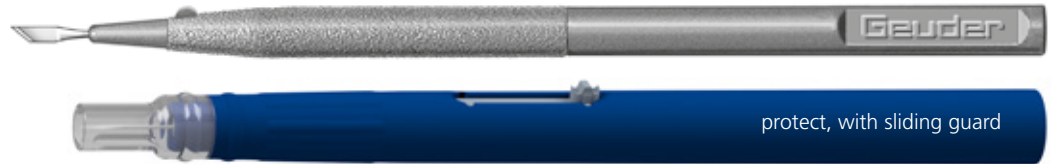

NANOEDGE PARACENTESIS KNIFE



G-34026 15°, straight
G-34064 15° protect



G-34031 22,5°, straight



G-34036 30°, straight
G-34065 30° protect

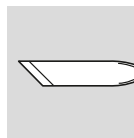

G-34041 45°, straight



NANOEDGE STAB BLADE TIP straight
G-34042 15°
G-34043 30°
G-34044 45°

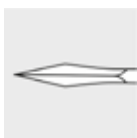

NANOEDGE MVR STILETTO
straight

diameter insertable instruments	incision / blade width
G-34176 19 gauge / 1.1 mm	1.4 mm
G-34181 20 gauge / 0.9 mm	1.2 mm
G-34192 23 gauge / 0.6 mm	0.8 mm
G-34198 25 gauge / 0.5 mm	0.7 mm



NANOEDGE CORNEAL SIDEPORT KNIFE
straight

incision / blade width
G-34070 1.0 mm
G-34071 1.2 mm



NANOEDGE MVR STILETTO
angled

diameter insertable instruments	incision / blade width
G-34177 19 gauge / 1.1 mm	1.4 mm
G-34063 19 gauge / 1.1 mm protect	1.4 mm
G-34191 20 gauge / 0.9 mm	1.2 mm
G-34196 23 gauge / 0.6 mm	0.8 mm
G-34197 25 gauge / 0.5 mm	0.7 mm

NANOEDGE CORNEAL SIDEPORT KNIFE
angled

incision / blade width
G-34072 1.0 mm
G-34073 1.2 mm



**NANOEDGE
PHACO SLIT KNIFE**

angled, double bevel

G-34050 1.80 mm

G-34092 2.20 mm

G-34060 2.20 mm, protect

G-34094 2.40 mm

G-34061 2.40 mm, protect

G-34053 2.50 mm

G-34054 2.75 mm

G-34055 2.85 mm

G-34062 2.85 mm, protect

G-34056 3.00 mm

G-34057 3.20 mm

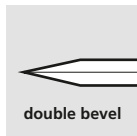

double bevel



**NANOEDGE
PHACO SLIT KNIFE**

angled, bevel up

G-34058 2.00 mm

G-34095 2.20 mm

G-34097 2.40 mm

G-34091 2.50 mm

G-34093 2.65 mm

G-34096 2.75 mm

G-34098 2.85 mm

G-34106 3.00 mm

G-34111 3.20 mm



bevel up



**NANOEDGE
CLEAR CORNEA KNIFE**

angled, double bevel

G-34066 1.30 mm,

with indicator

G-34067 2.40 mm,

with indicator

G-34120 2.65 mm

G-34122 2.75 mm

G-34124 2.85 mm

G-34126 3.00 mm

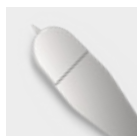

NANOEDGE PRECISION DEPTH KNIFE (LRI) straight

G-34076 300 µm

G-34077 350 µm

G-34078 500 µm

G-34079 600 µm



**NANOEDGE
CRESCENT KNIFE**

angled, bevel up

G-34081 2.0 mm



**NANOEDGE
CRESCENT BLADE TIP**

angled, bevel up

G-34045 2.0 mm

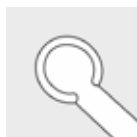

**NANOEDGE
SPOON KNIFE**

angled, double bevel

G-34086 2.2 mm



**NANOEDGE
SCLERAL BLADE**

straight

G-34074 3.5 – 4.0 mm



**NANOEDGE
LAMELLAR BLADE**

angled, bevel up

G-34075 2.3 mm

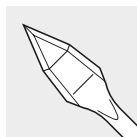

NANOEDGE TRAPEZOID CLEAR CORNEA IMPLANT KNIFE (CCI)

angled, with indicator

G-34152 1.5 – 2.0 mm

20G RED: 20 GAUGE / 0.9 MM

23G GREEN: 23 GAUGE / 0.6 MM

25G BLUE: 25 GAUGE / 0.5 MM

SCISSORS

SINGLE-USE VITREOUS SCISSORS UNO COLORLINE

straight, sterile

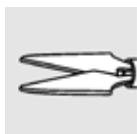

G-42061 20G, 1 pcs. per box

G-42361 23G, 1 pcs. per box

G-42561 25G, 1 pcs. per box



SINGLE-USE VITREOUS SCISSORS UNO COLORLINE

curved, sterile



G-42362 23G, 1 pcs. per box

G-46362 23G, 6 pcs. per box

G-42562 25G, 1 pcs. per box

G-46562 25G, 6 pcs. per box



HANDLES

HANDLE UNO COLORLINE 20G, 23G, 25G

titanium handle for UNO Colorline
single-use tips

G-40006 6 mm diameter

G-40008 8 mm diameter



20G RED: 20 GAUGE / 0.9 MM

23G GREEN: 23 GAUGE / 0.6 MM

25G BLUE: 25 GAUGE / 0.5 MM

FORCEPS

SINGLE-USE VITREOUS FORCEPS ENDGRIPPING UNO COLORLINE

straight, extra delicate,
endgripping, sterile



0.3 mm x 0.1 mm

G-42041 20G, 1 pcs. per box

G-46041 20G, 6 pcs. per box

0.2 mm x 0.05 mm

G-42341 23G, 1 pcs. per box

G-46341 23G, 6 pcs. per box

0.2 mm x 0.05 mm

G-42541 25G, 1 pcs. per box

G-46541 25G, 6 pcs. per box

HATTENBACH

SINGLE-USE VITREOUS FORCEPS WAVE DESIGN UNO COLORLINE

straight, wave design, sterile

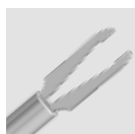

0.3 mm x 0.5 mm

G-42042 20G, 1 pcs. per box

G-46042 20G, 6 pcs. per box

0.2 mm x 0.5 mm

G-42342 23G, 1 pcs. per box

G-46342 23G, 6 pcs. per box

0.2 mm x 0.5 mm

G-42542 25G, 1 pcs. per box

G-46542 25G, 6 pcs. per box

SINGLE-USE VITREOUS FORCEPS CROCODILE DESIGN UNO COLORLINE

straight, crocodile design, sterile



0.3 mm x 2.5 mm

G-42043 20G, 1 pcs. per box

0.2 mm x 1.5 mm

G-42343 23G, 1 pcs. per box

G-46343 23G, 6 pcs. per box

SINGLE-USE TANO FORCEPS UNO COLORLINE

straight, sterile

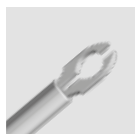

G-42044 20G, 1 pcs. per box

G-42344 23G, 1 pcs. per box

G-42544 25G, 1 pcs. per box

STRAIGHT LASER PROBES

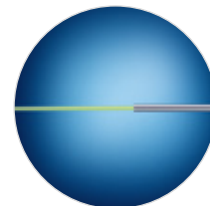

REF	SIZE	TYPE	LASER CONNECTOR
G-61508	20G	straight	Geuder, Zeiss, Alcon
G-61538	23G	straight	Geuder, Zeiss, Alcon
G-61558	25G	straight	Geuder, Zeiss, Alcon
G-61578	27G	straight	Geuder, Zeiss, Alcon
G-61601	20G	straight	Iridex
G-61631	23G	straight	Iridex
G-61651	25G	straight	Iridex
G-61671	27G	straight	Iridex

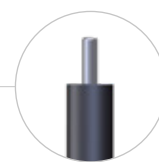

CURVED LASER PROBES

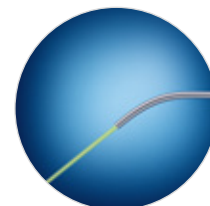

REF	SIZE	TYPE	LASER CONNECTOR
G-61509	20G	curved	Geuder, Zeiss, Alcon
G-61539	23G	curved	Geuder, Zeiss, Alcon
G-61559	25G	curved	Geuder, Zeiss, Alcon
G-61579	27G	curved	Geuder, Zeiss, Alcon
G-61603	20G	curved	Iridex
G-61633	23G	curved	Iridex
G-61653	25G	curved	Iridex
G-61673	27G	curved	Iridex

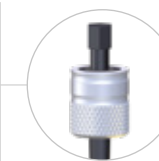
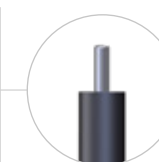

ENDO PROBES

BENDING LASER PROBES

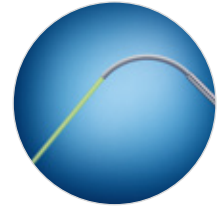

REF	SIZE	TYPE	LASER CONNECTOR
G-61501	20G	bending	Geuder, Zeiss, Alcon
G-61531	23G	bending	Geuder, Zeiss, Alcon
G-61551	25G	bending	Geuder, Zeiss, Alcon
G-61571	27G	bending	Geuder, Zeiss, Alcon
G-61503	20G	bending	Iridex
G-61533	23G	bending	Iridex
G-61553	25G	bending	Iridex
G-61573	27G	bending	Iridex

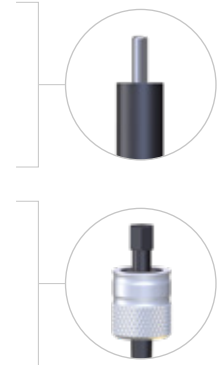

ILLUMINATED BENDING LASER PROBES

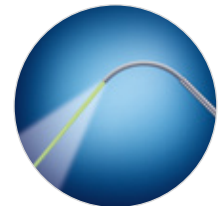

REF	SIZE	TYPE	LIGHT CONNECTOR	LASER CONNECTOR
G-61505	20G	illumin. bending	Geuder	Geuder, Zeiss, Alcon
G-61535	23G	illumin. bending	Geuder	Geuder, Zeiss, Alcon
G-61555	25G	illumin. bending	Geuder	Geuder, Zeiss, Alcon
G-61575	27G	illumin. bending	Geuder	Geuder, Zeiss, Alcon
G-61506	20G	illumin. bending	Alcon	Geuder, Zeiss, Alcon
G-61536	23G	illumin. bending	Alcon	Geuder, Zeiss, Alcon
G-61556	25G	illumin. bending	Alcon	Geuder, Zeiss, Alcon
G-61576	27G	illumin. bending	Alcon	Geuder, Zeiss, Alcon



ENDO PROBES

20G RED: 20 GAUGE / 0.9 MM

23G GREEN: 23 GAUGE / 0.6 MM

25G BLUE: 25 GAUGE / 0.5 MM

TROCAR SYSTEMS

HATTENBACH / NIKOLIC

SINGLE-USE TROCAR SYSTEM ONE-STEP UNO COLORLINE

3 ports for one-step technique, incl. infusion tubing, sterile

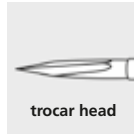
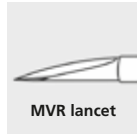

G-42311 23G, 1 set per box
G-46311 23G, 6 sets per box

G-42511 25G, 1 set per box
G-46511 25G, 6 sets per box

SINGLE-USE TROCAR PLUGS UNO COLORLINE



G-42319 23G, 1 set (3 pcs.) per box

FIBER OPTICS

SINGLE-USE FIBER OPTIC S UNO COLORLINE

spot, sterile

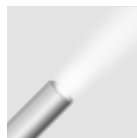

G-42021 20G, 1 pcs. per box
G-46021 20G, 6 pcs. per box

G-42321 23G, 1 pcs. per box
G-46321 23G, 6 pcs. per box

G-42521 25G, 1 pcs. per box
G-46521 25G, 6 pcs. per box

SINGLE-USE FIBER OPTIC W UNO COLORLINE

wide angle, sterile



G-42022 20G, 1 pcs. per box
G-46022 20G, 6 pcs. per box

G-42322 23G, 1 pcs. per box
G-46322 23G, 6 pcs. per box

G-42522 25G, 1 pcs. per box
G-46522 25G, 6 pcs. per box

TROCARS · FIBER OPTICS

20G RED: 20 GAUGE / 0.9 MM

23G GREEN: 23 GAUGE / 0.6 MM

25G BLUE: 25 GAUGE / 0.5 MM

SINGLE-USE FIBER OPTIC WS UNO COLORLINE

wide angle, shielded, sterile



G-42023 20G, 1 pcs. per box
G-46023 20G, 6 pcs. per box

G-42323 23G, 1 pcs. per box
G-46323 23G, 6 pcs. per box

G-42523 25G, 1 pcs. per box
G-46523 25G, 6 pcs. per box

VITREOUS CUTTERS

SINGLE-USE HIGH SPEED VITREOUS CUTTER UNO COLORLINE

pneumatic, with GEUDER safety-connector, sterile



G-42001 20G, 1 pcs. per box
G-46001 20G, 6 pcs. per box

G-42301 23G, 1 pcs. per box
G-46301 23G, 6 pcs. per box

G-42501 25G, 1 pcs. per box
G-46501 25G, 6 pcs. per box

SINGLE-USE HIGH SPEED VITREOUS CUTTER MACH 2 UNO COLORLINE

Doubleblade, pneumatic, with GEUDER safety-connector, sterile



G-42002 20G, 1 pcs. per box
G-46002 20G, 6 pcs. per box

G-42302 23G, 1 pcs. per box
G-46302 23G, 6 pcs. per box

G-42502 25G, 1 pcs. per box
G-46502 25G, 6 pcs. per box

FIBER OPTICS · VITREOUS CUTTERS · INFUSION TUBE

16

SINGLE-USE INFUSION TUBE 20G UNO COLORLINE

for 20 gauge GEUDER UNO Colorline vitreous cutters, sterile

G-42009 20G, 1 pcs. per box
G-46009 20G, 6 pcs. per box





SZURMAN

SINGLE-USE DMEK-CARTRIDGE

for Descemet Membrane Endothelial Keratoplasty
incl. tube connection for loading
the cartridge, sterile

G-38630

incision 2.8 to 3.0 mm, 14 gauge / 2.0 mm

G-38635

incision 2.4 to 2.75 mm, 16 gauge / 1.6 mm

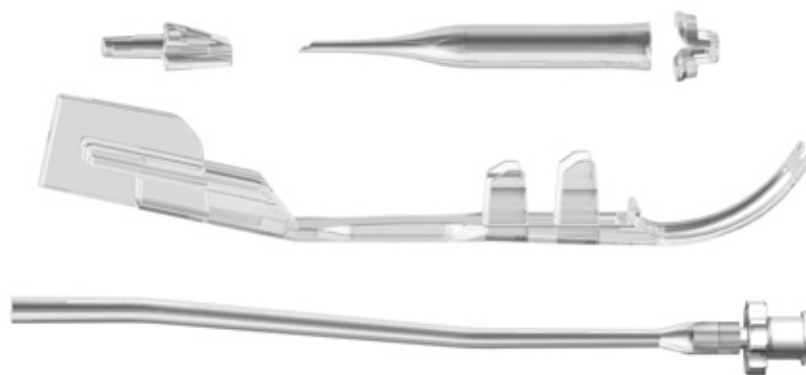

G-38626

SZURMAN

DMEK RAPID

Single-use DMEK transportation cartridge
for transportation of prepared
Descemet membrane for use in
Descemet membrane endothelial
keratoplasty (DMEK)
incl. cartridge, 2 plugs,
transportation holder for cartridge
and connection for loading the cartridge
6 sets per box, sterile

G-38611

**SINGLE-USE TUBING WITH
LUER CONNECTOR**

e.g. for rinsing and staining the
Descemet membrane
6 pcs. per box, sterile



G-34523-1

SINGLE-USE IRIS RETRACTOR

for mechanical dilation of the pupil, flexible
6 iris retractors per set, 5 sets per box, sterile



G-34810

LACRIMAL INTUBATION TUBING

silicone tubing 35 cm
OD 0.6 mm, ID 0.3 mm
10 pcs. per box, sterile



DMEK CARTRIDGE · IRIS RETRACTORS · LACRIMAL INTUBATION

G-34811 **LACRIMAL INTUBATION SET**
 suture with silicone tubing
 0.6 mm
 10 pcs. per box, sterile



G-34290 **SINGLE-USE LACRIMAL CANNULA**
 curved 26 gauge / 0.45 x 30 mm
 10 pcs. per box, sterile



G-34200 **SINGLE-USE RETROBULBAR CANNULA**
 10 pcs. per box, sterile
 25 gauge, 0.5 x 38 mm
G-34205
 26 gauge, 0.45 x 50 mm

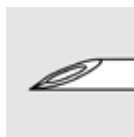

ATKINSON
G-34210 **SINGLE-USE RETROBULBAR CANNULA**
 10 per box, sterile
 25 gauge, 0.5 x 40 mm
G-34215
 23 gauge, 0.64 x 38 mm

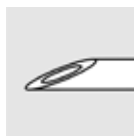

G-34220 **SINGLE-USE PERIBULBAR CANNULA**
 25 gauge, 0.5 x 32 mm
 10 pcs. per box, sterile

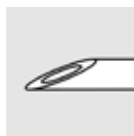

G-34225 **SINGLE-USE CYSTOTOME CANNULA**
 vaulted, 45°
 25 gauge / 0.5 mm
 10 pcs. per box, sterile
 12.5 mm long, side cutting
G-34230
 12.5 mm long



G-34261 *LEWICKY*
SINGLE-USE A. C. MAINTAINER
 20 gauge / 0.9 mm, tip 5 mm
 3 pcs. per box, sterile



INTUBATION SETS · CANNULAS (LACRIMAL, RETROBULBAR, CYSTOTOME, A.C. MAINTAINER)

G-34235 *RYCROFT*
SINGLE-USE A. C. CANNULA
angled at 7 mm, 45°
10 pcs. per box, sterile

G-34240
20 gauge, 0.9 x 5 + 17 mm
25 gauge, 0.5 x 25 mm



G-34245 *SAUTTER*
SINGLE-USE HYDRODISSECTION CANNULA
vertically flattened
27 gauge / 0.4 x 22 mm
10 pcs. per box, sterile



G-34270 *TUEBINGEN MODEL*
SINGLE-USE HYDRODISSECTION CANNULA
30 gauge / 0.3 x 19.5 mm
10 pcs. per box, sterile



G-34271 *FRANKFURT MODEL*
SINGLE-USE HYDRODISSECTION CANNULA
27 gauge / 0.4 mm x 15 mm
10 pcs. per box, sterile



G-34500 *SAAD*
SINGLE-USE UNFOLDING CANNULA
for unfolding Descemet membrane in DMEK
1 front port, 4 lateral ports
27 gauge / 0.4 mm
10 pcs. per box, sterile



G-34501 **SINGLE-USE DALK CANNULA**
for big-bubble technique of deep anterior lamellar keratoplasty (DALK)
27 gauge / 0.4 mm, curved, flattened tip
0.4 mm posterior port
10 pcs. per box, sterile

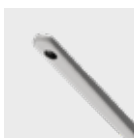

CANNULAS (A.C. MAINTAINER, RYCROFT, HYDRODISSECTION, UNFOLDING)

G-34265 **SINGLE-USE IRRIGATION VECTIS CANNULA**
 double port
 25 gauge / 0.5 mm
 10 pcs. per box, sterile

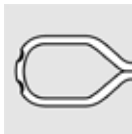

G-34255 *KRATZ*
SINGLE-USE CAPSULE POLISHING CANNULA
 angled at 9 mm, 45°
 closed tip with sideport, textured
 23 gauge / 0.6 mm
 10 pcs. per box, sterile



G-34280 *SIMCOE*
SINGLE-USE I/A CANNULA
 0.4 mm diameter aspiration port
 front opening irrigation port
 23 gauge / 0.64 mm
 10 pcs. per box, sterile

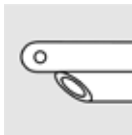

G-15197 **SINGLE-USE IRRIGATION CANNULA**
 for viscocanalostomy
 26 gauge / 0.45 mm shaft
 35 gauge / 0.21 mm angled tip
 5 mm tapered tube, curved
 5 pcs. per box, sterile



G-80975 **SINGLE-USE INJECTION CANNULA**
 for EasyGas®
 30 gauge / 0.3 x 12 mm
 100 pcs. per box, sterile

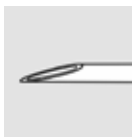



G-34400 SINGLE-USE BIMANUAL I/A HANDPIECE SET

consisting of:
 · Irrigation Handpiece, irrigation ports 2 x 0.6 mm
 · Aspiration Handpiece, aspiration port 0.4 mm
 · rough tip tube 21 gauge / 0.8 mm
 5 pcs. per box, sterile

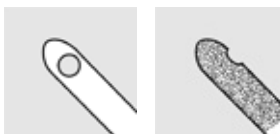

G-34289 SINGLE-USE BACKFLUSH HANDPIECE

with silicone chamber, Luer-Lock
 10 pcs. per box, sterile



G-34806 SINGLE-USE SILICONE CHAMBER

for backflush handpieces G-31805,
 G-37000 and G-37002
 10 pcs. per box, sterile



G-34275 SINGLE-USE BACKFLUSH CANNULA

inside diameter 25 gauge / 0.5 mm
 outside diameter 21 gauge / 0.8 x 35 mm
 10 pcs. per box, sterile



SINGLE-USE BACKFLUSH CANNULA

blunt tip
 10 pcs. per box, sterile

- G-34291** 20 gauge / 0.9 mm
- G-34296** 23 gauge / 0.6 mm
- G-34299** 25 gauge / 0.5 mm

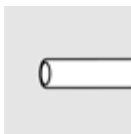

SINGLE-USE BACKFLUSH CANNULA

with silicone brush
 5 pcs. per box, sterile

- G-34293** 20 gauge / 0.9 mm
- G-34294** 23 gauge / 0.6 mm
- G-34297** 25 gauge / 0.5 mm

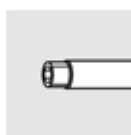

SINGLE-USE BACKFLUSH CANNULA

with silicone tip
5 pcs. per box, sterile
20 gauge / 0.9 mm
23 gauge / 0.6 mm
25 gauge / 0.5 mm

- G-34292
- G-34295
- G-34298

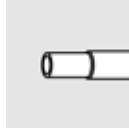

G-34285

SINGLE-USE PFCL CANNULA

for injection of heavy fluids
dual bore, coaxial
23 gauge / 0.64 mm
10 pcs. per box, sterile

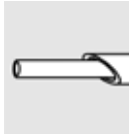

SINGLE-USE VFI CANNULA FOR OIL I/A

for silicone oil injection/aspiration
polyimide tip 6 mm, thin-walled
10 pcs. per box, sterile
20 gauge / 0.9 mm
23 gauge / 0.6 mm
25 gauge / 0.5 mm
27 gauge / 0.4 mm

- G-34493
- G-34494
- G-34495
- G-34496



SINGLE-USE CANNULA

to inject silicone oil
10 pcs. per box, sterile
20 gauge / 0.9 mm x 8 mm
23 gauge / 0.6 mm x 8 mm

- G-34497
- G-34498

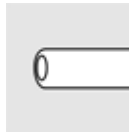

G-33482

SINGLE-USE INJECTION CANNULA

for viscous fluids, self-retaining, 4.0 mm tip
with 25 cm PVC tube
Luer-Lock plastic adapter
20 gauge / 0.9 mm
5 pcs. per box, sterile



G-33463

SINGLE-USE INFUSION CANNULA



self-retaining, 4.0 mm tip
with 25 cm silicone tube
Luer-Lock plastic adapter
20 gauge / 0.9 mm
5 pcs. per box, sterile





CANNULAS (BACKFLUSH WITH SILICONE TIP, PFCL, SILICONE OIL, INFUSION)

G-33468 **SINGLE-USE INFUSION CANNULA**
with 25 cm silicone tube
Luer-Lock plastic adapter
20 gauge / 0.9 mm
5 pcs. per box, sterile
beveled tip, 4.0 mm

G-33469
beveled tip, 6.0 mm



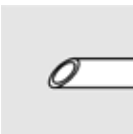

G-33462 **SINGLE-USE INFUSION CANNULA**
4.0 mm beveled tip
with 25 cm PVC tube
Luer-Lock plastic adapter
25 gauge / 0.5 mm
10 pcs. per box, sterile



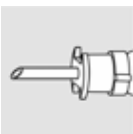

G-33488 **SINGLE-USE INJECTION CANNULA**
for viscous fluids
with 1 metal sleeve, Luer-Lock plastic adapter
and 25 cm PVC tube
20 gauge / 0.9 mm
5 pcs. per box, sterile
beveled tip, 4.0 mm

G-33489
beveled tip, 6.0 mm

G-34480 **SINGLE-USE INJECTION CANNULA**
for viscous fluids
4.0 mm beveled tip
with 2 metal sleeves, Luer-Lock plastic adapter
and 25 cm silicone tube
19 gauge / 1.1 mm
10 pcs. per box, sterile

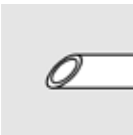
G-34492 *KIRCHHOF*
SINGLE-USE INJECTION CANNULA
for gas / viscous fluids
5.0 mm beveled tip with 4 infusion side ports
2 metal sleeves, Luer-Lock plastic adapter and
40 cm silicone tube
20 gauge / 0.9 mm
10 pcs. per box, sterile



G-32696 **SINGLE-USE PRESSURE TUBE**
for injection of viscous fluid, Luer-Lock female / male
10 pcs. per box, sterile



G-31891 **SINGLE-USE SYRINGE**
Luer-Lock, 10 ml, sterile



G-38610 **SINGLE-USE SYRINGE BD EMERALD™**
Luer slip, 5 ml, sterile
100 pcs. per box



G-31520 **SINGLE-USE MINI FILTER**
0.1 µm, sterile



G-23991 **SINGLE-USE THREE-WAY STOP COCK**
2x Luer-Lock female, 1x Luer-Lock male
plastic, sterile



G-30146 **SINGLE-USE AIR INJECTION TUBE**
for MEGATRON S3 / S4 HPS
incl. filter 0.1 µm and 2-way-stopcock
length 1.9 m
6 pcs. per box, sterile



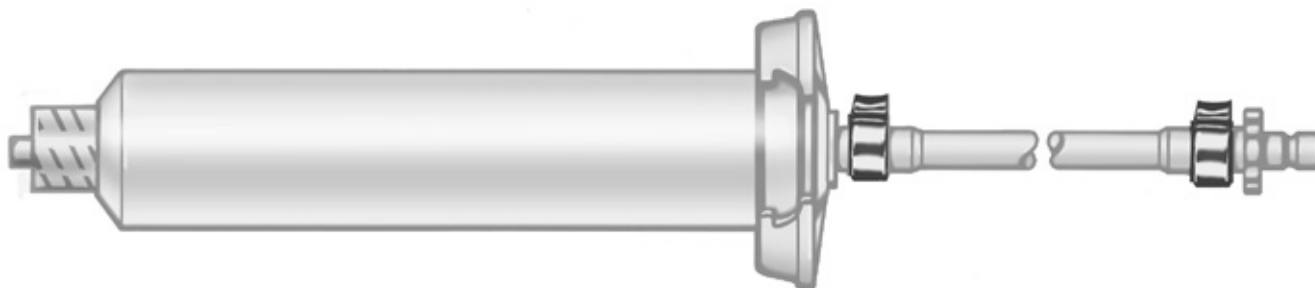

G-28766 **SINGLE-USE OIL INJECTION SYSTEM**
to inject silicone oil pneumatically,
with protective cover for glass syringe,
pressure tube fits megaTRON® S3 / S4 HPS and
Pentasy® 2, sterile

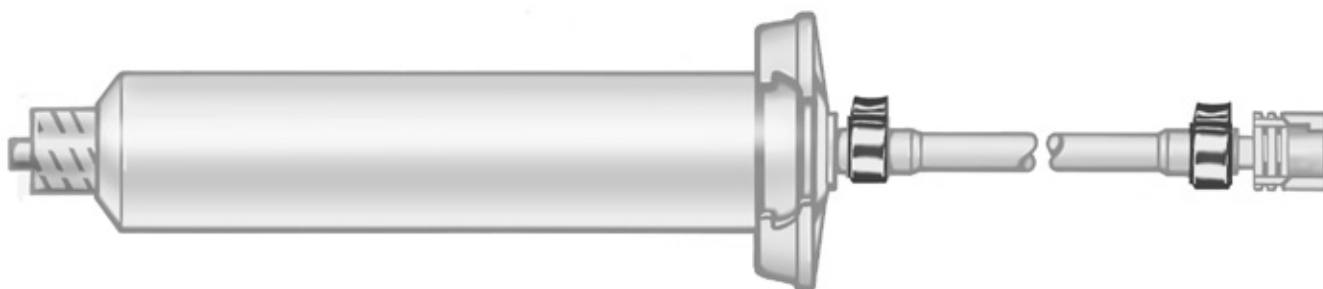

G-28767 **SINGLE-USE OIL INJECTION SYSTEM**
to inject silicone oil pneumatically,
with protective cover for glass syringe,
pressure tube fits megaTRON® and Accurus® ,sterile

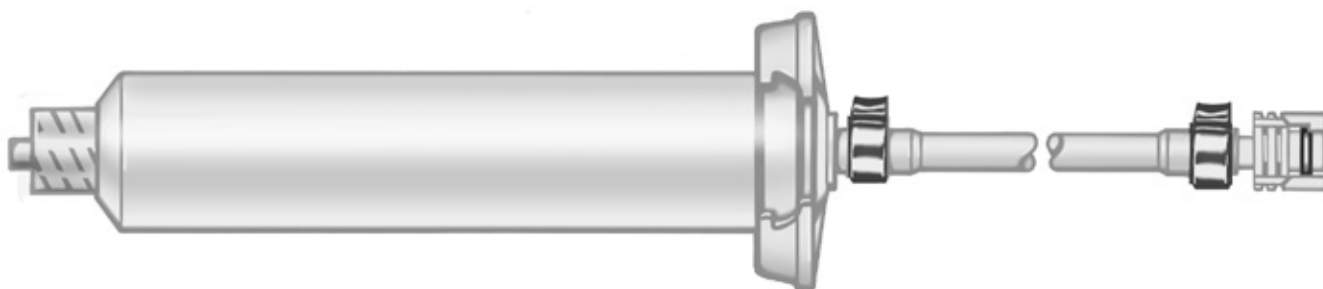

G-28768 **SINGLE-USE OIL INJECTION SYSTEM**
to inject silicone oil pneumatically,
with protective cover for glass syringe,
pressure tube fits Millennium® , sterile

G-19826 **SINGLE USE LOW TEMPERATURE BATTERY CAUTERY**
 fine tip, 427 °C - 482 °C
 10 pcs. per box, sterile



G-19827 **SINGLE USE HIGH TEMPERATURE BATTERY CAUTERY**
 fine tip, 704 °C - 1500 °C
 10 pcs. per box, sterile



G-32700 **SCALPEL HANDLE**



G-18127 **ABSORBENT SWABS**
 17 mm long
 box of 20 pouches
 10 swabs per pouch
 sterile

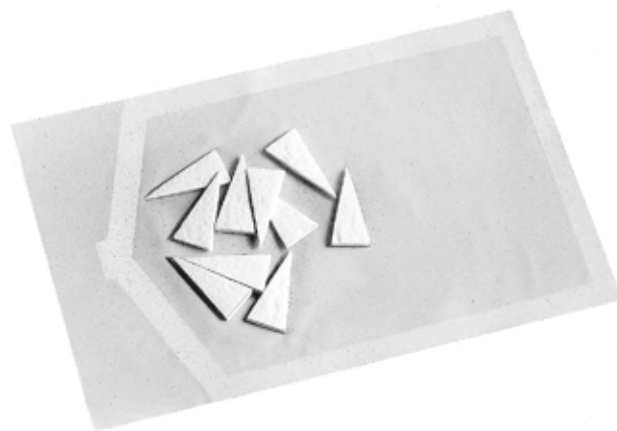

G-33786 **MARKING PEN**
 gentian violet
 dual tip, fine and broad
 to ink corneal instruments
 20 pcs. per box, sterile



BATTERY CAUTERY · SCALPEL HANDLE · ABSORBENT SWABS · MARKING PEN

G-34602 276 STYLE SILICONE TIRE, ASYMMETRICAL

7.0 mm wide
2.5 mm groove
5 pcs. per box, sterile



7.0
2.5

G-34606 280 STYLE SILICONE TIRE, ASYMMETRICAL

10.0 mm wide
2.5 mm groove
5 pcs. per box, sterile



10.0
2.5

G-34608 286 STYLE SILICONE TIRE, CONVEX

6.0 mm wide
2.5 mm groove
5 pcs. per box, sterile



6.0
2.5

G-34610 287 STYLE SILICONE TIRE, CONVEX

7.0 mm wide
2.5 mm groove
5 pcs. per box, sterile



7.0
2.5

G-34616 277 STYLE SILICONE TIRE, CONCAVE

7.0 mm wide
2.5 mm groove
5 pcs. per box, sterile



7.0
2.5

G-34618 279 STYLE SILICONE TIRE, CONCAVE

9.0 mm wide
2.5 mm groove
5 pcs. per box, sterile

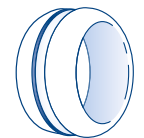

9.0
2.5

G-34620 40 STYLE SILICONE CIRCLING BAND

W 2.0 x H 0.75 x L 125 mm
5 pcs. per box, sterile

Suitable sleeves:

G-34642 (round)
G-34645 (oval)

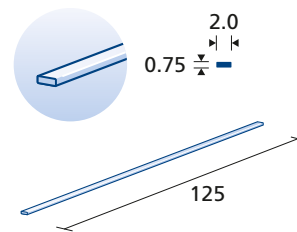

G-34622 240 STYLE SILICONE CIRCLING BAND

W 2.5 x H 0.6 x L 125 mm
5 pcs. per box, sterile

Suitable sleeves:

G-34645 (oval)
G-34646 (round)

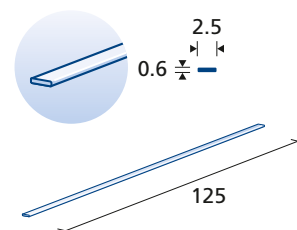

G-34624 41 STYLE SILICONE STRIP

W 3.5 x H 0.75 x L 125 mm
5 pcs. per box, sterile

Suitable sleeves:

G-34647 (oval) and G-34644 (round)

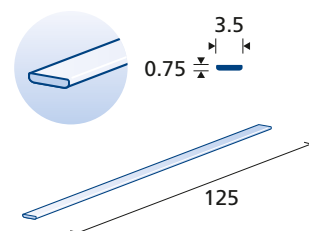

G-34626 42 STYLE SILICONE STRIP

W 4.0 x H 1.25 x L 125 mm
5 pcs. per box, sterile

Suitable sleeves:

G-34647 (oval) and G-34644 (round)

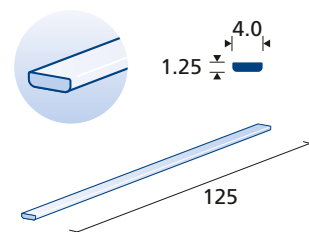

G-34628 4050 STYLE SILICONE STRIP

W 5.0 x H 1.0 x L 125 mm
5 pcs. per box, sterile

Suitable sleeves:

G-34647 (oval) and G-34644 (round)

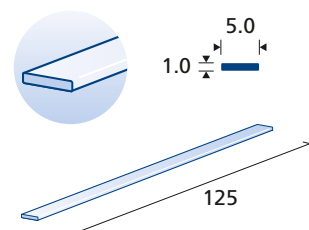

G-34636 219 STYLE GROOVED SILICONE STRIP

W 4.5 x H 1.25 x L 100 mm
2.5 mm groove
5 pcs. per box, sterile

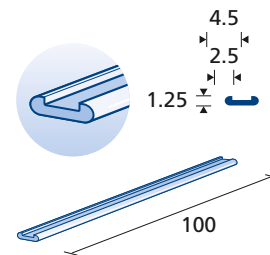

G-34638 220 STYLE GROOVED SILICONE STRIP

W 6.0 x H 1.5 x L 100 mm
2.5 mm groove
5 pcs. per box, sterile

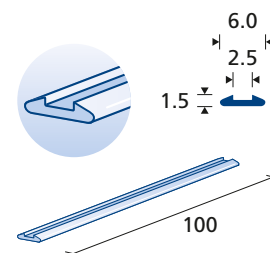

G-34646 270 STYLE SILICONE SLEEVE

Ø 0.76 mm inside
Ø 1.65 mm outside
30 mm long
5 pcs. per box, sterile

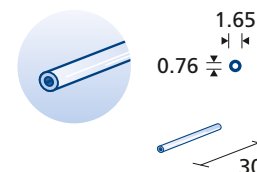

G-34642 70 STYLE SILICONE SLEEVE

Ø 1.0 mm inside
Ø 2.1 mm outside
30 mm long
5 pcs. per box, sterile

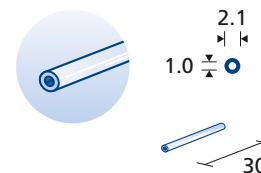

G-34644 72 STYLE SILICONE SLEEVE

Ø 1.5 mm inside
Ø 2.4 mm outside
30 mm long
5 pcs. per box, sterile

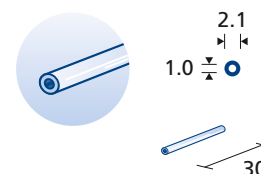

G-34645 3083 STYLE OVAL SILICONE SLEEVE

Ø 1.5 mm inside
 Ø 2.5 mm outside
 5 mm long
 5 pcs. per box, sterile

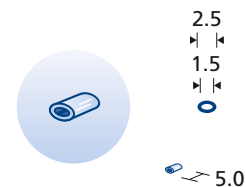

G-34647 3084 STYLE OVAL SILICONE SLEEVE

Ø 1.5 mm inside
 Ø 3.75 mm outside
 5 mm long
 5 pcs. per box, sterile

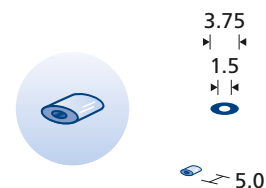

G-34656 503 STYLE ROUND SILICONE SPONGE IMPLANT

ø: 3.0 mm
 80 mm long
 5 pcs. per box, sterile

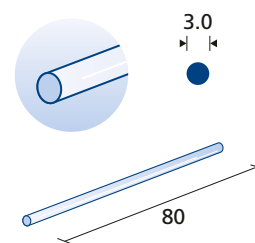

G-34658 504 STYLE ROUND SILICONE SPONGE IMPLANT

ø: 4.0 mm
 80 mm long
 5 pcs. per box, sterile

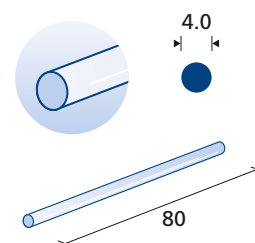

G-34660 505 STYLE ROUND SILICONE SPONGE IMPLANT

ø: 5.0 mm
 80 mm long
 5 pcs. per box, sterile

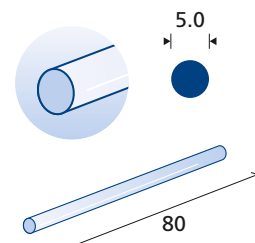

G-34664 **501 STYLE OVAL SILICONE SPONGE IMPLANT**
W 4.0 x H 2.5 x L 80 mm
5 pcs. per box, sterile

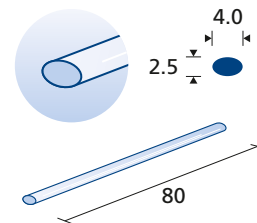

G-34666 **506 STYLE OVAL SILICONE SPONGE IMPLANT**
W 5.0 x H 3.0 x L 100 mm
5 pcs. per box, sterile

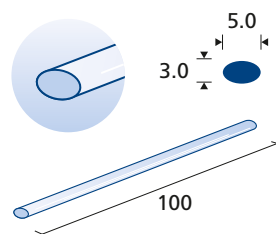

G-34668 **507 STYLE OVAL SILICONE SPONGE IMPLANT**
W 7.5 x H 5.5 x L 80 mm
5 pcs. per box, sterile

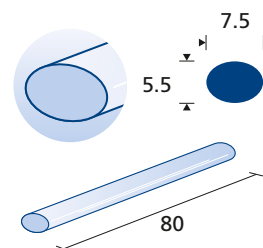

G-34672 **506G STYLE GROOVED SILICONE SPONGE IMPLANT**
2.5 mm groove
W 5.0 x H 3.0 x L 80 mm
5 pcs. per box, sterile

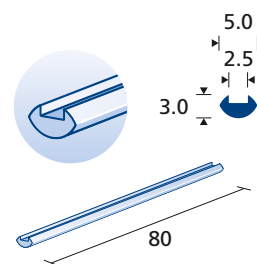

G-34678 **509G STYLE GROOVED SILICONE SPONGE IMPLANT**
2.5 mm groove
W 7.5 x H 3.5 x L 80 mm
5 pcs. per box, sterile

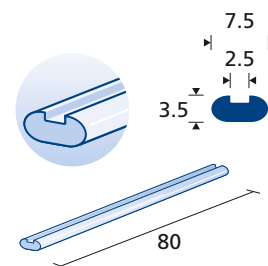

G-34680 **516G STYLE GROOVED SILICONE SPONGE IMPLANT**
 2.5 mm groove
 W 6.4 x H 2.3 x L 80 mm
 5 pcs. per box, sterile

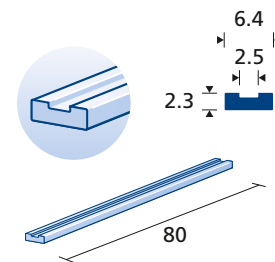

G-34684 **510 STYLE SEMI-CIRCULAR SILICONE SPONGE IMPLANT**
 W5.0 x H2.5 x L80mm
 5 pcs. per box, sterile

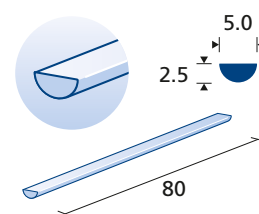

G-34686 **511 STYLE SEMI-OVAL SILICONE SPONGE IMPLANT**
 W7.5 x H2.75 x L80mm
 5 pcs. per box, sterile

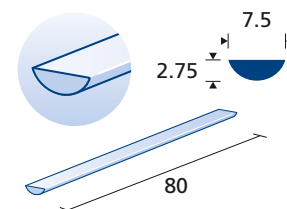

G-34688 **515 STYLE SEMI-OVAL SILICONE SPONGE IMPLANT**
 W5.0 x H3.33 x L80mm
 5 pcs. per box, sterile

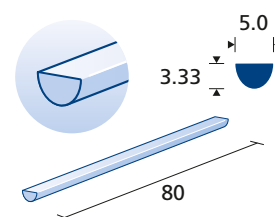

SILICONE SPONGE IMPLANTS

G-34710**BONN INJECTION SET**

single-use set for intravitreal injection (IVOM)
consisting of:

- measuring and fixation instrument, 3.5 / 4.0 mm
 - eye speculum
 - irrigation cannula
 - cannula 0.9 x 70 mm
 - syringe 1 ml
 - syringe 10 ml
 - eye drape with pre-cut adhesive incise-film 140 x 140 cm
 - absorbent swab (3x)
 - gauze compress 10 x 10 (2x)
 - protective cover 60 x 60 cm
- 10 pcs. per box, sterile



MISCELLANEOUS



CAPSULAR TENSION RING INJECTORS / PUPIL DILATORS.....	247
LACRIMAL / DCR.....	248
BONE CHISELS · LASEK TREPHINE · FASCIA NEEDLE.....	249
DIAMOND BURR · VITRECTOMY LENSES.....	250
EYE SHIELD · BATTERY CAUTERY · INTRAOCULAR MAGNET.....	251
DIATHERMY INSTRUMENTS.....	252

G-32955

INJECTOR

for capsular tension ring
shaft diameter 1.2 mm
for 1.9 mm incisions
shaft length 30 mm
overall length 156 mm



G-32960

INJECTOR

for *MORCHER* capsular tension ring
shaft diameter 1.2 mm
for 1.9 mm incisions
shaft length 30 mm
overall length 156 mm



G-32965

INJECTOR

for *MORCHER* capsular ring
shaft diameter 1.6 mm
for 2.4 - 2.5 mm incisions
shaft length 30 mm
overall length 156 mm



G-32970

INJECTOR

for *MORCHER* pupil dilator
overall length 140 mm



G-31810 *FRIEDMANN*
RONGEUR
overall length 140 mm



scale 2:3

G-32355 **NASAL SPECULUM**
overall length 150 mm



scale 2:3

G-33125 *MEAD*
HAMMER
300 g, lead filled
overall length 190 mm



scale 2:3

G-18630 *HEIDELBERG MODEL*
ELEVATORIUM
overall length 143 mm



G-18620 *HEIDELBERG MODEL*
RASPATORY
overall length 155 mm





G-18240 *WEST*
BONE CHISEL
for lacrimal sac
flat, 5.0 mm wide
overall length 160 mm



G-18245 *WEST*
BONE GOUGE
for lacrimal sac
concave, 5.0 mm wide
overall length 162 mm



G-33650
G-33652
LASEK TREPHINE
with crosshairs
overall length 100 mm
8.0 mm
9.0 mm

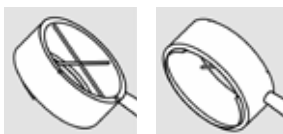

G-33655
G-33657
LOHMANN
LASEK FUNNEL
with crosshairs
overall length 100 mm
8.5 mm
9.5 mm



G-32313 *WRIGHT*
FASCIA NEEDLE
overall length 115 mm





- DIAMOND BURR**
top, inside, outside coat
- G-18300** 8.0 mm
 - G-18301** 9.0 mm
 - G-18302** 10.0 mm

- G-36000** *KILP*
LENS
60 D flat, field of vision 20°, silicone ring
central posterior pole and central vitreous body



- G-36010** *LANDERS*
LENS
93 D, biconcave with silicone ring
clear view of fundus in air-filled phakic eye



- G-36015** *MACHEMER*
LENS
with silicone ring to magnify structures
in vitreous cavity or on retinal surface



- G-36020** *PEYMAN*
LENS
wide field of vision 30°, with silicone ring
for central fundus and central vitreous body



- G-36025** *TOLENTINO*
LENS
prism 20° with silicone ring
posterior peripheral fundus and
posterior peripheral vitreous body



- G-36030** *TOLENTINO*
LENS
prism 30° with silicone ring
peripheral viewing beyond the equator



- G-36045** **SILICONE REPLACEMENT RING**
for *KILP* lens G-36000



DIAMOND BURR · VITRECTOMY LENSES

G-36050 SILICONE REPLACEMENT RING
for lenses from G-36010 to G-36035



G-36065 LENS HANDLE RING
for lenses without silicone ring
to suture on to sclera
for G-36000



G-31105 EYESHIELD
plastic, transparent for use on both eyes
100 pcs. per bag



G-19826 SINGLE USE LOW TEMPERATURE BATTERY CAUTERY
fine tip, 427 °C - 482 °C
10 pcs. per box, sterile



G-19827 SINGLE USE HIGH TEMPERATURE BATTERY CAUTERY
fine tip, 704 °C - 1500 °C
10 pcs. per box, sterile



G-31900 KUHN INTRAOCULAR MAGNET
30 mm shaft, 1.9 mm outside diameter
4 mm magnetic tip
overall length 90 mm



EYE SHIELD · BATTERY CAUTERY · INTRAOCULAR MAGNET

G-31215 **BIPOLAR FORCEPS**
straight, 100 mm
(sterilizable in autoclave only)



G-31216 **BIPOLAR FORCEPS**
angled, 100 mm
(sterilizable in autoclave only)



G-31218 **BIPOLAR HANDPIECE**
diameter 1.1 mm
G-31219 diameter 0.9 mm



G-25030 **INTRAOCULAR**
DIATHERMY PROBE
20 gauge / 0.9 mm
G-25032 23 gauge / 0.64 mm
G-25034 25 gauge / 0.5 mm

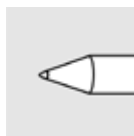
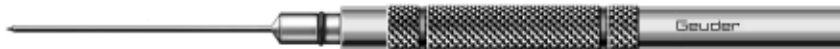

G-28220 **DIATHERMY**
CONNECTION CABLE



STERILIZATION CONTAINERS AND ADAPTERS

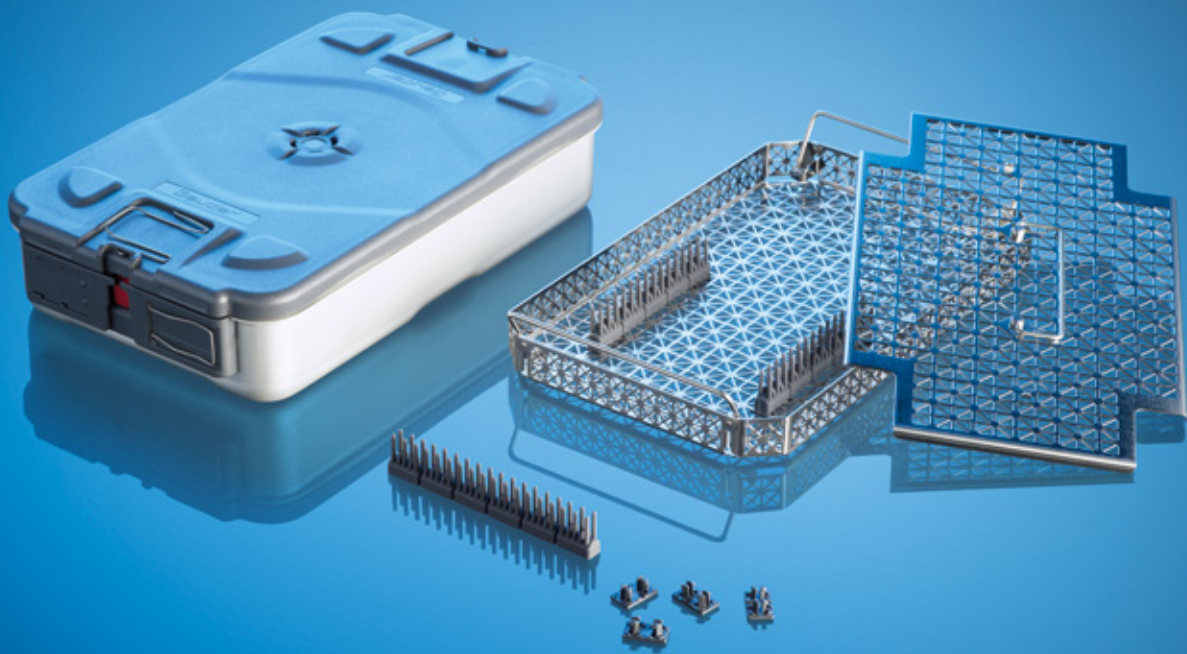

MICROSTOP [®] CONTAINERS AND ACCESSORIES	255
MICROSTOP [®] · FILTERS FOR STEEL CASES	257
TRAYS AND RACKS FOR STEEL CASES	258
SILICONE STRIPS · SILICONE MATS · SEALS	259
SMALL CASES	260
STERISAFE [®] CONTAINERS AND ACCESSORIES	261
STERISAFE [®] GRIDS · RINSING ADAPTER AND TUBING	265
CLEANING ADAPTERS	266

G-39745 **MICROSTOP[®]**
STERILIZATION CONTAINER LOW
for one tray
outside dimensions: 310 x 189 x 70 mm
inside dimensions: 283 x 177 x 50 mm



G-39750 **MICROSTOP[®]**
STERILIZATION CONTAINER HIGH
for two trays
outside dimensions: 310 x 189 x 90 mm
inside dimensions: 283 x 177 x 70 mm



G-39783 **MICROSTOP[®]**
STERILIZATION TRAY MINI
29 mm, low
size: 277 x 172 x 29 mm
without lid
G-39786 with lid



G-39785 **MICROSTOP[®]**
STERILIZATION TRAY MINI
38 mm, high
size: 277 x 172 x 38 mm
without lid
G-39784 with lid



MICROSTOP[®]

G-39787 **MICROSTOP®**
STERILIZATION TRAY LID MINI
 size: 277 x 172 mm
 for G-39783 and G-39785

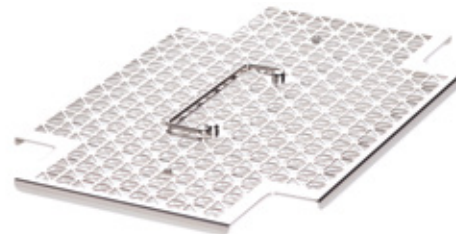

G-39782 **MICROSTOP®**
RETAINER ELEMENT
 for MICROSTOP® tray mini
 nap Style, 120 mm
 separable into 6 single elements
 29 mm, low
G-39789 38 mm, high



G-39788 **MICROSTOP®**
CLIP FOR RETAINER ELEMENTS
 G-39782 and G-39789
 10 pcs. per bag



G-39791 **MICROSTOP®**
ID LABEL
 for tray, aluminium
 customized labeling
 silver-colored



G-39741 **MICROSTOP®**
LABEL
 for lid, customized labeling



G-39746 **MICROSTOP®**
ID LABEL
 for front, customized labeling



**MICROSTOP[®]
LOGISTIC FRAME**
for lid to use with labels

- G-39753** color: red
- G-39754** color: blue
- G-39755** color: green



G-39762 **MICROSTOP[®]
SEAL**
with indicator
1000 pcs. per box

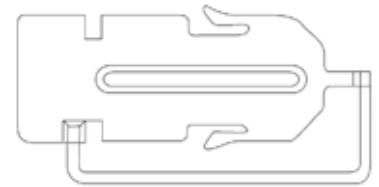

G-39764 **MICROSTOP[®]
TAG**
with indicator
1000 pcs. per box



G-31649 **INDICATOR**
for steam sterilization, slim
1000 pcs. per box



PERMANENT TEXTILE FILTER
for steam sterilization cases

- G-31650** for G-19822, G-19823
- G-31651** for G-19841, G-19842, G-19843, G-19876, G-28150, G-28151
- G-31652** 6 perforations, for G-19877, G-19892, G-19894
- G-31656** for G-19877
- G-31661** for G-19890



G-31655 **PAPER FILTER**
for steam sterilization cases
G-19841, G-19842, G-19843,
G-19851, G-19856, G-19876,
G-28150, G-28151
100 pcs. per box



G-32675 **SILICONE TRAY**
with bottom
outside dimensions: 160 x 85 x 20 mm



G-32660 **STERILIZATION RACK**
for 12 cannulas, silicone
outside dimensions: 85 x 56 x 8 mm



G-19870 **STERILIZATION RACK**
for 10 instruments with handle, silicone
outside dimensions: 160 x 85 x 20 mm



G-32785 **SILICONE PERFORATED TRAY**
outside dimensions: 194 x 135 x 24 mm

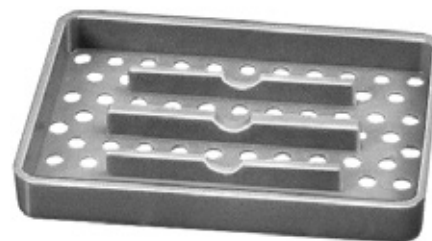

G-32676 **SILICONE NAP STRIP BLUE**
340 x 30 mm



G-32677 **SILICONE STRIP BLUE**
350 mm long



G-19866 **SILICONE BURL MAT**
perforated
240 x 230 mm
G-19865 300 x 150 mm
G-19867 470 x 245 mm



G-19899 **SILICONE PLATE**
perforated, 270 x 185 mm
for hot air sterilization cases
G-19841, G-19842,
G-19846, G-19847

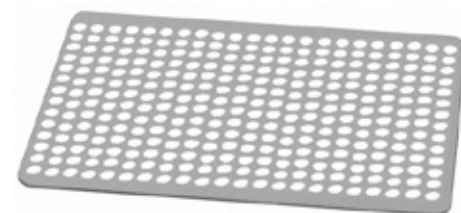

G-31657 **SAFETY SEAL**
for steam sterilization cases
100 pcs. per box



G-31659 **SEAL**
for hot-air sterilization cases
100 pcs. per box



SILICONE STRIPS · SILICONE MATS · SEALS

G-32695 **SILICONE CLOSURE**
17 cm long



G-33100 **STERILIZATION CASE**
for 1 vitreoretinal instrument or diamond knife
plastic, with 2 bridges (steam sterilization)
outside dimensions: 195 x 60 x 25 mm



G-33101 **STERILIZATION CASE**
for 1 vitreoretinal instrument
plastic, with burl mat (steam sterilization)
outside dimensions: 195 x 60 x 25 mm

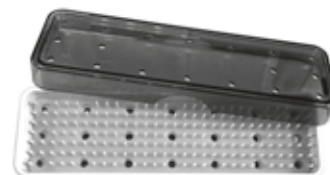

G-33102 **STERILIZATION CASE**
for 4-5 instruments
plastic, with burl mat (steam sterilization)
outside dimensions: 200 x 110 x 28 mm

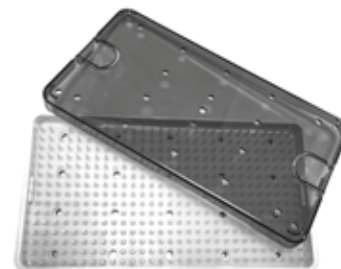

G-39527 **STERISAFE[®] DURO A4 PLUS**
 container for steam, gas (EO, FO) and plasma
 sterilization, without trays and strips
 outside dimensions: 290 x 190 x 70 mm
 inside dimensions: 265 x 165 x 60 mm



G-39526 **STERISAFE[®] DURO A4 PLUS COMPLETE SET**
 container for steam, gas (EO, FO) and plasma
 sterilization, including:
 1 x Sterisafe[®] wire basket A4-30
 5 x Sterisafe[®] silicone retainer strips 230 mm
 1 x Sterisafe[®] metal tray A4-30
 outside dimensions: 290 x 190 x 70 mm
 inside dimensions: 265 x 165 x 60 mm

G-39525 **STERISAFE[®] DURO A4**
 container for steam, gas (EO, FO) and plasma
 sterilization
 outside dimensions: 290 x 190 x 60 mm
 inside dimensions: 265 x 165 x 49 mm



G-39528 **STERISAFE[®] DURO A6**
 container for steam, gas (EO, FO) and plasma
 sterilization
 outside dimensions: 190 x 110 x 60 mm
 inside dimensions: 165 x 92 x 49 mm



G-39543 **STERISAFE[®] DURO WIRE BASKET A4-30**
 outside dimensions: 260 x 163 x 30 mm
 inside dimensions: 249 x 157 x 23 mm



G-39541 STERISAFE® DURO METAL TRAY A4-15

outside dimensions: 260 x 163 x 15 mm
inside dimensions: 249 x 157 x 11 mm



G-39542 STERISAFE® DURO METAL TRAY A4-30

outside dimensions: 260 x 163 x 30 mm
inside dimensions: 249 x 157 x 26 mm

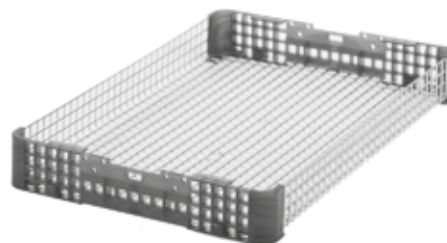

G-39549 STERISAFE® DURO WIRE BASKET A6-30

outside dimensions: 162 x 90 x 30 mm
inside dimensions: 156 x 80 x 23 mm



G-39548 STERISAFE® DURO METAL TRAY A6-15

outside dimensions: 162 x 90 x 15 mm
inside dimensions: 156 x 80 x 11 mm

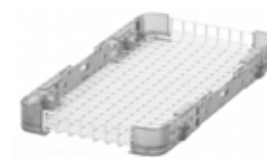

G-39545 STERISAFE® SILICONE RETAINER STRIP 75

for Sterisafe® DURO A4 and A6
length: 75 mm



G-39546 **STERISAFE[®] SILICONE RETAINER STRIP 145**
for Sterisafe[®] DURO A4 and A6
length: 145 mm



G-39547 **STERISAFE[®] SILICONE RETAINER STRIP 230**
for Sterisafe[®] DURO A4 and A6
length: 230 mm



G-39501 **STERISAFE[®] FILTER**
A4 10 pcs. per box
G-39511 A6 10 pcs. per box



G-39530 **STERISAFE[®] FILTER TAG EXPIRATION DATE**
10 pcs. per box



G-39535 **SEAL / LABEL**
seal with color indicator and blank label
2000 pcs. per box

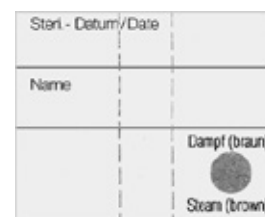

G-39540 **SECURITY SEAL**
100 pcs. per box



STERISAFE[®] DURO

G-39502 **STERISAFE® SILICONE BURL MAT**
G-39512 A4
 A6

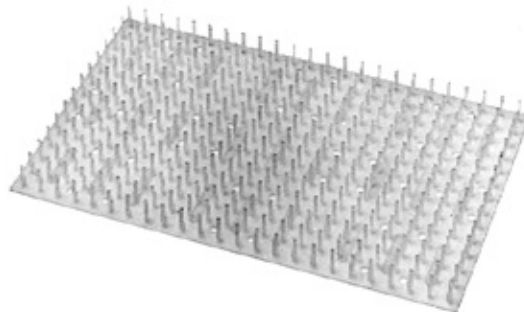

G-39506 **STERISAFE® SILICONE BURL MAT**
 for metal grid insert
 A4



G-39503 **STERISAFE® SILICONE GRID INSERT**
G-39513 A4
 A6

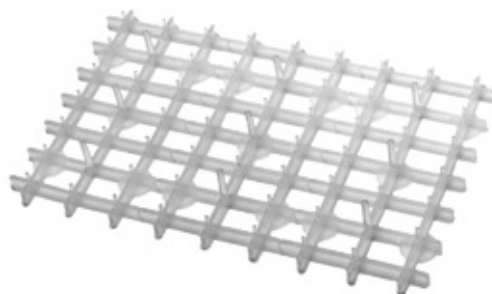

G-39514 **STERISAFE® METAL GRID INSERT**
 A6



STERISAFE® DURO

- G-39505** **STERISAFE[®] METAL GRID INSERT**
 with 2 silicone burl strips
 A4

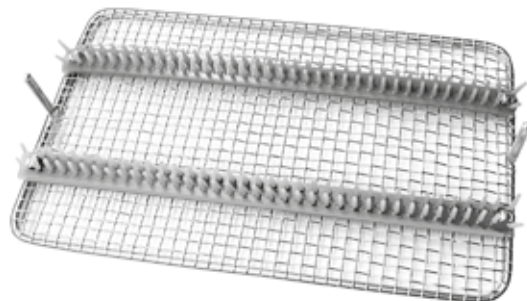

- G-31670** **MELAG METAL GRID INSERT**
 with 2 silicone nap strips
 outside dimensions: 370 x 147 x 50 mm
 for MELAG sterilizing case

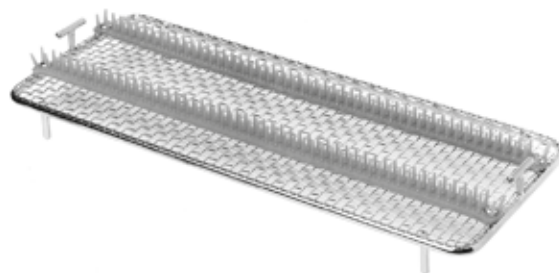

- G-39544** **RINSING ADAPTER FOR WIRE BASKETS**
 including 4 silicone tubings
 - 2 male Luer adapters
 - 2 female Luer-Lock adapters
 and 2 screws



- G-39557** **SILICONE TUBINGS FOR G-39544**
 Set of 4 pcs.
 - 2 male Luer adapters
 - 2 female Luer-Lock adapters
 10 sets per box



G-31028 **CLEANING ADAPTER**
for ultrasonic handpieces (irrigation connector)
Luer female / male



G-31029 **CLEANING ADAPTER**
for ultrasonic handpieces (aspiration connector)
Luer female / female



G-31021 **CLEANING ADAPTER**
for ultrasonic tips



G-31013 **CLEANING ADAPTER**
for *HATTENBACH* 25 gauge hybrid instruments
(G-32944, G-32947 and G-32948)

G-22636 **ADAPTER**
for *PAPST I/A* handpiece
light model

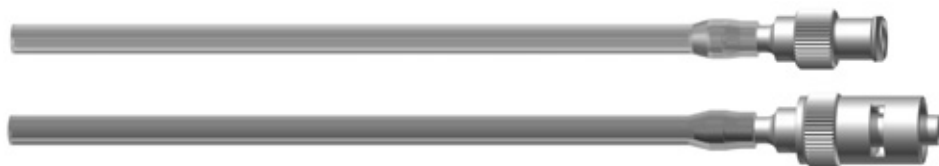

G-31025 **CLEANING ADAPTER**
metal
for cleaning I/A handpieces
Luer-Lock female / female



G-31026 **CLEANING ADAPTER**
plastic
for cleaning I/A handpieces
Luer-Lock female / female



G-31016 **CLEANING ADAPTER**
for diamond knives, small



G-31017 **CLEANING ADAPTER**
for diamond knives, large



G-31022 **CLEANING ADAPTER**
for G-37010 - G-37080



G-31031 **CLEANING ADAPTER**
for aspiration handpiece G-37100 and G-37105
Luer-Lock female / silicone tube
2.1 x 1.0 mm



G-31018 **CLEANING ADAPTER**
for PFCL cannula G-33055
Luer-Lock female / silicone tube



G-31024 **CLEANING ADAPTER**
for eye specula with aspiration



G-31023 **CLEANING ADAPTER**
for lacrimal cannulas with handle
and lateral aspiration port 0.40 mm
G-33141 and G-33142



G-31027 **CLEANING ADAPTER**
for *JUENEMANN* probes





G-31034 **CLEANING ADAPTER**
for foreign body instruments G-14530, G-14540, G-14550
Luer-Lock female

G-31014 **CLEANING ADAPTER**
for cannulas G-33057 and G-33059
Luer-Lock female



G-36604 **CLEANING ADAPTER**
for rotatable and interchangeable tips



PLEASE READ YOUR INSTRUMENT'S
CLEANING INSTRUCTIONS OR ASK
YOUR LOCAL SALES REPRESENTATIVE
FOR THE RIGHT CLEANING ADAPTER.

19

SETS

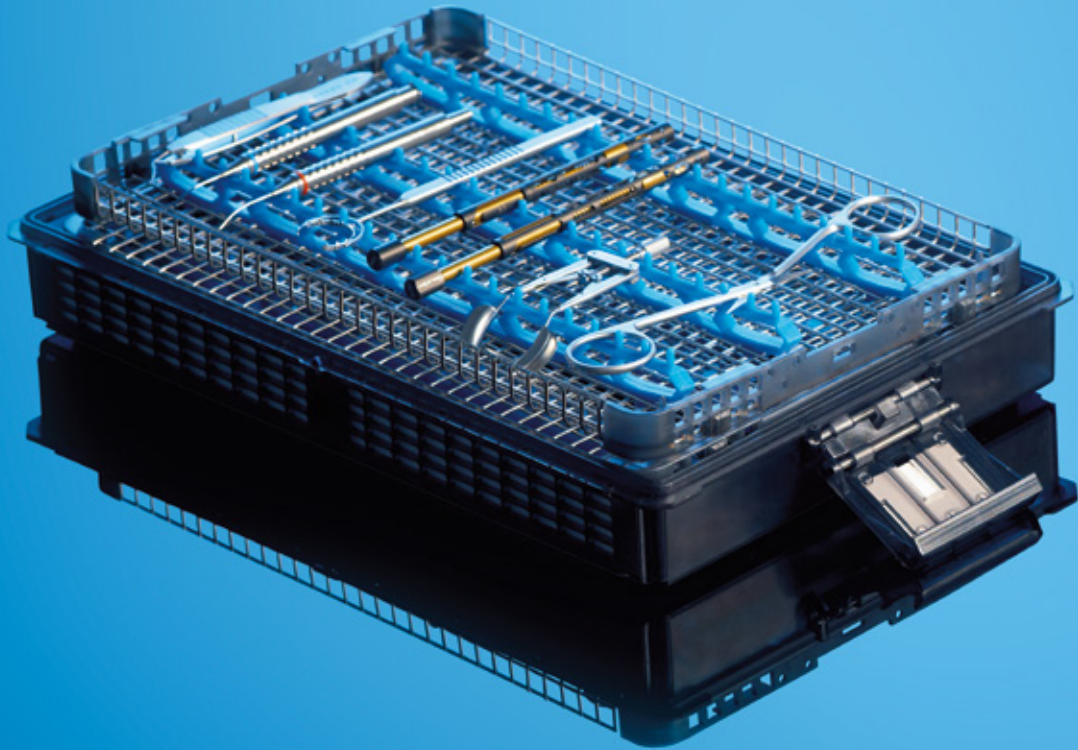

Geuder[®]
Precision made in Germany

CONTENT SETS

ECCE – Extra Capsular Cataract Extraction	272
Phaco / Cataract	273
Phaco Emergency · MSICS – Manual Small Incision Cataract Surgery	274
MICS – Micro Incision Cataract Surgery · FLACS – Femtosecond Laser-assisted Cataract Surgery	275
IOL Explantation · Toric IOL · IOL Scleral Fixation	276
Iris Suture	276
LASEK · LASIK	277
Femto LASIK · ReLex SMILE	278
Keratoplasty	279
DSEK / DSAEK · DALK	280
DMEK	281
Glaucoma	282
Emergency	283
Enucleation · Pterygium	284
Office Set (Optometrist) · Chalazion	285
Lid / Ptosis	286
DCR / LACRIMAL	287
Strabismus / Muscle	288
Retinal Detachment	289
Vitrectomy 20G	290 – 291
Vitrectomy 23G	292 – 293
Vitrectomy 25G	294

ECCE - EXTRA CAPSULAR CATARACT EXTRACTION

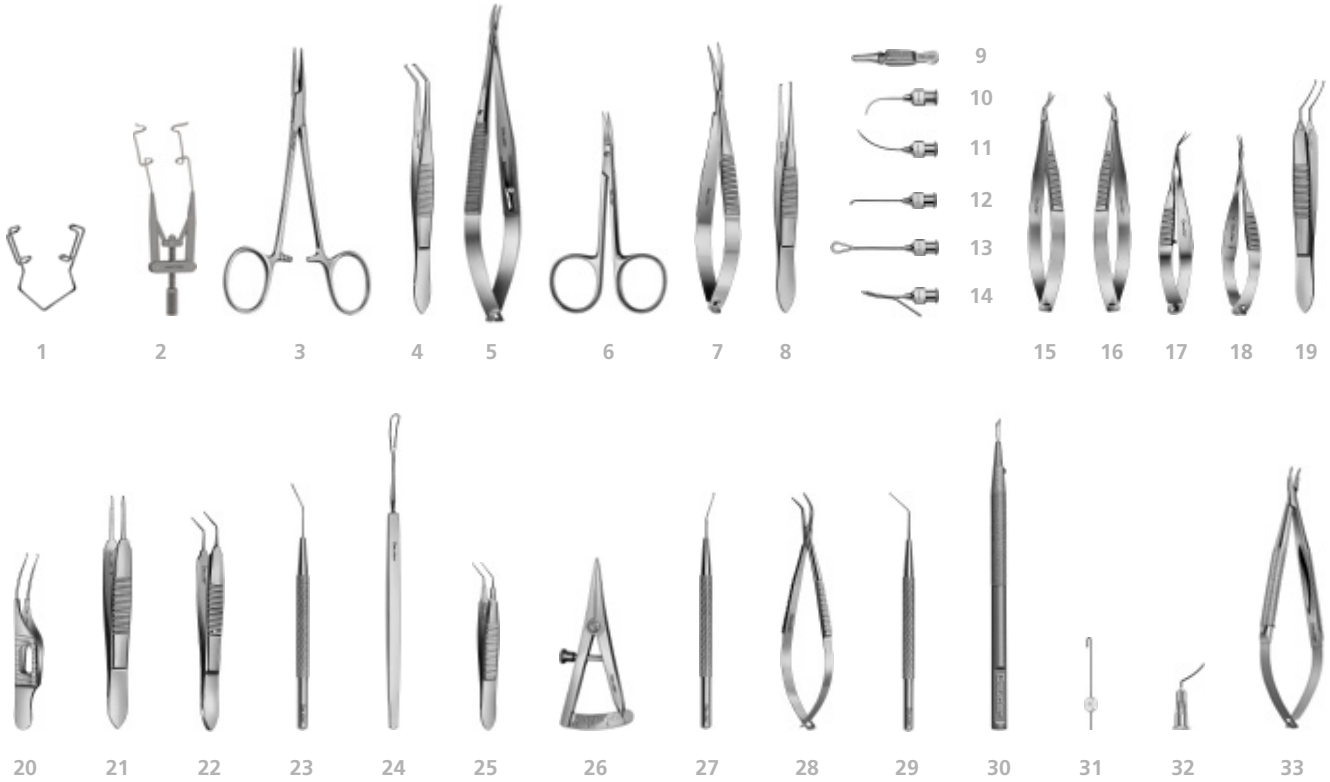

		page			page
1	G-17020 <i>BARRAQUER EYE SPECULUM</i> fenestrated.....	15	20	G-18960 <i>MICRO COLIBRI FORCEPS</i> with tying platform.....	104
2	G-15960 <i>LIEBERMAN EYE SPECULUM</i>	25	21	G-19030 <i>TUEBINGEN TYING FORCEPS</i> straight.....	106
3	G-18180 <i>HALSTEAD MOSQUITO FORCEPS</i> straight.....	135	22	G-19032 <i>TYING FORCEPS</i> angled, 7.5 mm.....	107
4	G-18820 <i>REMKY SUPERIOR RECTUS FORCEPS</i>	126	23	G-16189 <i>SPATULA</i> angled, 0.5 mm wide.....	160
5	G-17575 <i>CASTROVIEJO NEEDLE HOLDER</i> curved, w. lock.....	142	24	G-15620 <i>ARLT LENS LOOP</i> serrated.....	162
6	G-19400 <i>BONN EYE SCISSORS</i> curved, delicate.....	92	25	G-18910 <i>BONN IRIS FORCEPS</i> angled, 8.0 mm, 1 x 2 teeth.....	110
7	G-19750 <i>WESTCOTT SCISSORS</i> blunt tips, curved, 12 cm.....	89	26	G-19130 <i>CASTROVIEJO CALIPER</i> 15 mm.....	43
8	G-18791 <i>DRESSING FORCEPS</i> 1 x 2 teeth, 0.7 mm.....	110	27	G-16175 <i>DARDENNE IRIS HOOK</i> push-pull.....	158
9	G-18190 <i>DIEFFENBACH SERREFINE</i> straight, 35 mm.....	136	28	G-18935 <i>DODEN IMPLANTATION FORCEPS</i>	122
10	G-15185 <i>FRANKFURT HYDRODISSECTION CANNULA</i> 27G.....	194	29	G-16167 <i>SINSKEY LENS MANIPULATION HOOK</i> 0.2 mm.....	157
11	G-15250 <i>SAUTTER HYDRODIS. CANNULA</i> 27G, vert flat.....	194	30	G-34026 <i>NANOEDGE PARACENTESIS KNIFE</i> 15° straight.....	219
12	G-16125 <i>KRATZ CAPSULE POLISHING CANNULA</i>	197	31	G-34523-1 <i>SINGLE-USE IRIS RETRACTOR</i> flexible, 2 x 4 pcs.....	227
13	G-16115 <i>IRRIGATION VECTIS CANNULA</i>	195	32	G-34225 <i>SINGLE-USE CYSTOTOME CANNULA</i>	228
14	G-16106 <i>SIMCOE I/A CANNULA</i> 23G, dual shaft.....	196	33	G-17500 <i>BARRAQUER NEEDLE HOLDER</i> curved, w/o lock.....	139
15	G-19710 <i>TROUTMAN CORNEAL SCISSORS</i> right, curved.....	81	34	G-39786 <i>MICROSTOP® TRAY MINI</i> low, with lid.....	255
16	G-19715 <i>TROUTMAN CORNEAL SCISSORS</i> left, curved.....	81	35	G-39783 <i>MICROSTOP® TRAY MINI</i> low, without lid.....	255
17	G-19776 <i>CAPSULOTOMY SCISSORS</i> angled up.....	83	36	G-39782 <i>MICROSTOP® RETAINER ELEMENT</i> low.....	256
18	G-19765 <i>VANNAS CAPSULOTOMY SCISSORS</i> curved.....	84	37	G-39750 <i>MICROSTOP® CONTAINER HIGH</i> for two trays.....	255
19	G-31305 <i>CAPSULORHEXIS FORCEPS</i> extra delicate.....	114			

ECCE - EXTRA CAPSULAR CATARACT EXTRACTION

PHACO / CATARACT

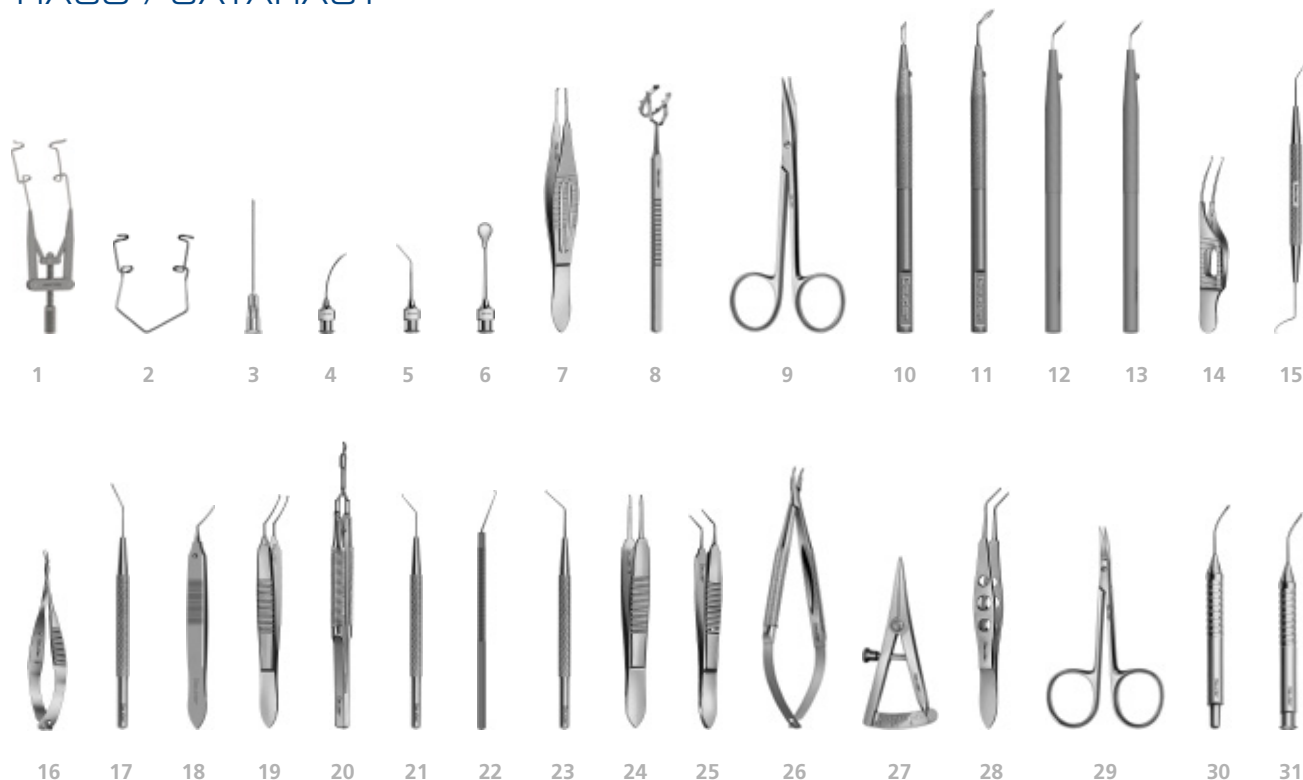

	page		page
1 G-15960 LIEBERMAN EYE SPECULUM.....	25	19 G-31305 CAPSULORHEXIS FORCEPS extra delicate.....	114
2 G-32148 BARRAQUER EYE SPECULUM fenestrated.....	16	20 G-31720 AKAHOSHI PRECHOPPER for micro-incisions.....	120
3 G-34210 ATKINSON SINGLE-USE RETROBULBAR CANNULA.....	228	21 G-31507 NAGAHARA NUCLEUS DIVIDING HOOK.....	153
4 G-15250 SAUTTER HYDRODIS. CANNULA 27G, vert flat.....	194	22 G-31509 JACOBOVITZ MULTIFUNCTIONAL CHOPPER.....	152
5 G-15151 LACRIMAL CANNULA conical, short angle, steel.....	191	23 G-16167 SINSKEY LENS MANIPULATION HOOK 0.2 mm.....	157
6 G-15200 CRANZ EYE DOUCHE silver.....	193	24 G-19030 TUEBINGEN TYING FORCEPS straight.....	106
7 G-19023 CASTROVIEJO SUTURING FORCEPS new, 0.3 mm.....	103	25 G-19032 TYING FORCEPS angled, 7.5 mm.....	107
8 G-33758 CLEAR-CORNEA-INCISION FIXATION RING.....	150	26 G-17500 BARRAQUER NEEDLE HOLDER curved, w/o lock.....	139
9 G-19485 STEVENS TENOTOMY SCISSORS curved, long.....	89	27 G-19130 CASTROVIEJO CALIPER 15 mm.....	43
10 G-34026 NANOEDGE PARACENTESIS KNIFE 15° straight.....	219	28 G-31901 HOLDING FORCEPS for foldable IOLs.....	125
11 G-34055 NANOEDGE PHACO SLIT KNIFE angled, 2.85 mm.....	220	29 G-19400 BONN EYE SCISSORS curved, delicate.....	92
12 G-34092 NANOEDGE PHACO SLIT KNIFE angled, 2.2 mm.....	220	30 G-22100 KOCH-KOHNEN ASPIRATION HANDPIECE 22G.....	200
13 G-34094 NANOEDGE PHACO SLIT KNIFE angled, 2.4 mm.....	220	31 G-22101 KOCH-KOHNEN IRRIGATION HANDPIECE 22G.....	201
14 G-18960 MICRO COLIBRI FORCEPS with tying platform.....	104	32 G-39786 MICROSTOP® TRAY MINI low, with lid.....	255
15 G-32162 THOMAS NEUHANN IRIS HOOK (Push-Pull) and NUCLEUS DIVIDING HOOK.....	154	33 G-39783 MICROSTOP® TRAY MINI low, without lid.....	255
16 G-19765 VANNAS CAPSULOTOMY SCISSORS curved.....	84	34 G-39782 MICROSTOP® RETAINER ELEMENT low.....	256
17 G-16189 SPATULA angled, 0.5 mm wide.....	160	35 G-39750 MICROSTOP® CONTAINER HIGH for two trays.....	255
18 G-32926 AUFFARTH MICS DOUBLE CROSS ACTION CAPSULORHEXIS FORCEPS flat handle.....	115		

PHACO EMERGENCY

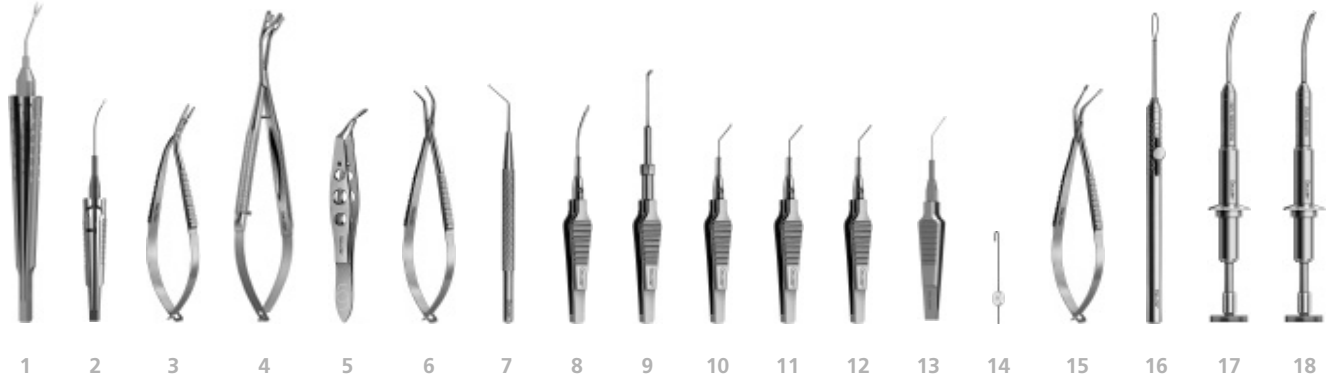

	page		page
1 G-32996 SNYDER-OSHER IOL SCISSORS 18G/1.2mm, long.....	88	11 G-32947 HATTENBACH HYBRID TYING FORCEPS 25G.....	108
2 G-32997 SNYDER-OSHER IOL FORCEPS 22G / 0.7 mm.....	125	12 G-32948 HATTENBACH HYBRID SCISSORS 25G.....	86
3 G-32945 STEINMETZ IOL SCISSORS.....	87	13 G-32949 HATTENBACH HYBRID NEEDLE HOLDER angled.....	143
4 G-31994 H.-R. KOCH PREFOLDER for foldable IOLs.....	124	14 G-34523-1 SINGLE-USE IRIS RETRACTOR flexible, 2 x 4 pcs.....	227
5 G-31905 H.-R. KOCH FOLDER for 3-piece IOLs.....	Seite 124	15 G-32823 EXPLANTATION FORCEPS for soft IOLs.....	125
6 G-18935 DODEN IMPLANTATION FORCEPS.....	122	16 G-32800 H.-R. KOCH SILICONE LENS BI-SECTOR.....	88
7 G-16167 SINSKEY LENS MANIPULATION HOOK 0.2 mm.....	157	17 G-32960 INJECTOR for MORCHER capsule tension ring.....	247
8 G-32935 H.-R. KOCH CAPSULE FORCEPS shaft 22G.....	115	18 G-32970 INJECTOR for MORCHER pupil dilator.....	247
9 G-32940 H.-R. KOCH CAPSULE SCISSORS 45° angled.....	85	19 G-39526 STERISAFE DURO A4 PLUS COMPLETE SET.....	261
10 G-32944 HATTENBACH CAPSULORHEXIS FORCEPS angled.....	117		

MSICS - MANUAL SMALL INCISION CATARACT SURGERY

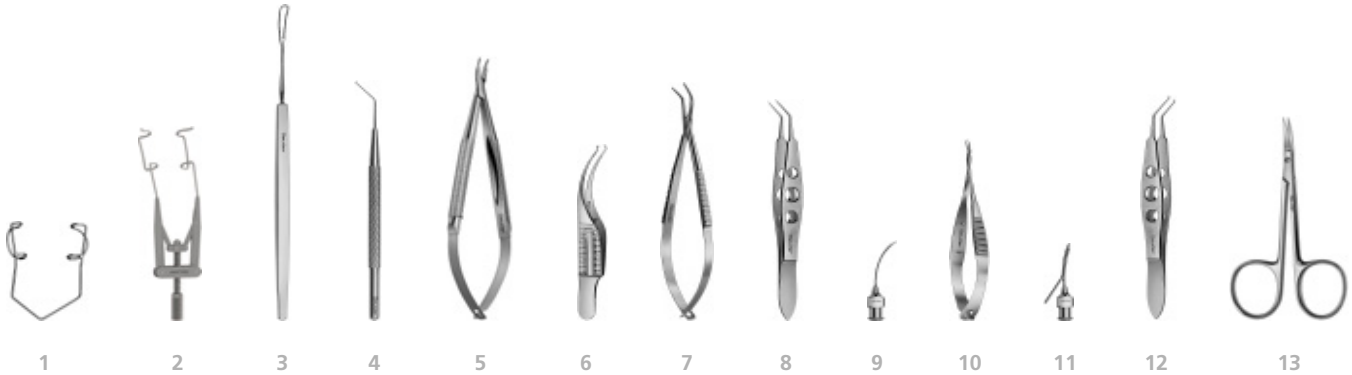

	page		page
1 G-32136 BARRAQUER EYE SPECULUM fenest., round.....	16	8 G-31622 GASKIN FRAGMENT FORCEPS angled, 9.0 mm.....	108
2 G-15960 LIEBERMAN EYE SPECULUM.....	25	9 G-15250 SAUTTER HYDRODIS. CANNULA 27G, vert flat.....	194
3 G-15620 ARLT LENS LOOP serrated, 3.5 mm wide.....	162	10 G-19765 VANNAS CAPSULOTOMY SCISSORS curved.....	84
4 G-16167 SINSKEY LENS MANIPULATION HOOK 0.2 mm.....	157	11 G-16106 SIMCOE I/A CANNULA 23G, dual shaft.....	196
5 G-17500 BARRAQUER NEEDLE HOLDER curved, w/o lock.....	139	12 G-31307 UTRATA CAPSULORHEXIS FORCEPS strong.....	113
6 G-18950 COLIBRI FORCEPS with tying platform.....	104	13 G-19400 BONN EYE SCISSORS curved, delicate.....	92
7 G-18935 DODEN IMPLANTATION FORCEPS.....	122		

MICS - MICRO INCISION CATARACT SURGERY



1 2 3 4 5 6 7 8 9

	page		page
1 G-38448 DIACLEAN CCI DIAMOND KNIFE trapez. 1.5/2.0.....	60	6 G-32012 IRRIGATION HANDPIECE 2x0.5 mm, con., text., 21G	202
2 G-32926 AUFFARTH MICS CAPSULORHEXIS FORCEPS	115	7 G-32011 ASPIRATION HANDPIECE 0.3 mm port, 21G.....	202
3 G-38240 JAPAN HANDLE for capsule forceps and scissors.....	85	8 G-31507 NAGAHARA NUCLEUS DIVIDING HOOK	153
4 G-38244 IKEDA CAPSULORHEXIS FORCEPS 23G, micro-tips	116	9 G-32505 TH. NEUHANN NUCLEUS DIVIDING HOOK	151
5 G-38246 YAE CAPSULE SCISSORS 23G, interchangeable.....	85		

FLACS - FEMTOSECOND LASER-ASSISTED CATARACT SURGERY

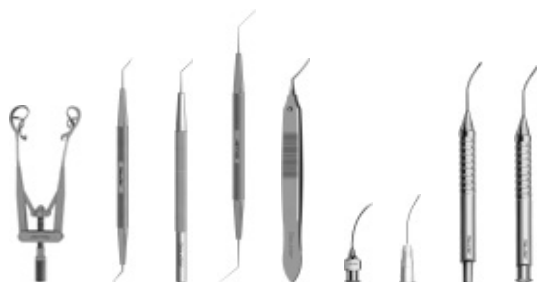

1 2 3 4 5 6 7 8 9

	page		page
1 G-33965 DICK FEMTOCATARACT EYE SPECULUM	26	6 G-15250 SAUTTER HYDRODIS. CANNULA 27G, vert flat.....	194
2 G-33966 DICK FEMTOCATARACT SPATULA double ended....	170	7 G-34245 SAUTTER SINGLE-USE HYDRODISSECTION	
3 G-33967 BREYER FEMTOCATARACT SPATULA blunt tip.....	170	CANNULA	229
4 G-33968 HOFFMANN FEMTOCATARACT NUCLEUS		8 G-22100 KOCH-KOHNEN ASPIRATION HANDPIECE 22G.....	200
ROTATOR AND CHOPPER	170	9 G-22101 KOCH-KOHNEN IRRIGATION HANDPIECE 22G.....	201
5 G-32926 AUFFARTH MICS CAPSULORHEXIS FORCEPS	115	10 G-39526 STERISAFE DURO A4 PLUS COMPLETE SET	261

IOL EXPLANTATION

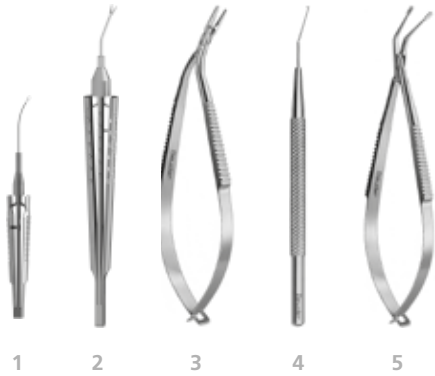

	page
1 G-32997 SNYDER-OSHER IOL FORCEPS 22G / 0.7 mm.....	125
2 G-32998 SNYDER-OSHER IOL SCISSORS 18G/1.2mm, short....	88
3 G-32945 STEINMETZ SCISSORS.....	87
4 G-16175 PUSH-PULL.....	158
5 G-32823 FORCEPS FOR SOFT IOLS.....	125

TORIC IOL



	page
1 G-33777 TOMARK ADJUSTABLE CORNEAL MARKER.....	47
2 G-33776 TOMARK PENDULUM INSTRUMENT handheld.....	47
3 G-33774 SCOTT CORNEAL PENDULUM MARKER.....	46
4 G-33763 GERTEN HORIZONTAL AXIS MARKER.....	46
5 G-16130 CAPSULE POLISHING CANNULA 18G / 1.2 mm.....	197
6 G-32564 RENTSCH CAPSULE POLISHING CURETTE 90°.....	161
7 G-33786 MARKING PEN gentian violet, 20 pcs./box.....	236

IOL SCLERAL FIXATION



	page
1 G-31496 YAMANE DOUBLE NEEDLE STABILIZER 30G.....	151
2 G-31497 YAMANE DOUBLE NEEDLE STABILIZER 27G.....	151
3 G-19826 SINGLE-USE LOW TEMPERATURE BATTERY CAUTERY.....	236
4 G-32949 HATTENBACH HYBRID NEEDLE HOLDER 25G.....	143
5 G-32947 HATTENBACH HYBRID TYING FORCEPS 25G.....	108
6 G-32948 HATTENBACH HYBRID SCISSORS 25G.....	86

IRIS SUTURE



	page
1 G-32949 HATTENBACH HYBRID NEEDLE HOLDER 25G.....	143
2 G-32947 HATTENBACH HYBRID TYING FORCEPS 25G.....	108
3 G-32948 HATTENBACH HYBRID SCISSORS 25G.....	86

IOL EXPLANTATION · TORIC IOL · IOL SCLERAL FIXATION · IRIS SUTURE

LASEK - LASER-ASSISTED EPITHELIAL KERATOMILEUSIS

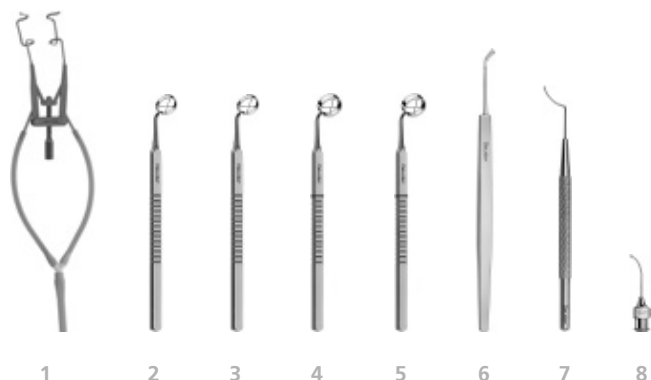

	page		page
1 G-15961 <i>LIEBERMAN ASPIRATION SPECULUM</i>	28	5 G-33657 <i>LOHMANN LASEK FUNNEL 9.5 mm, w crosshairs</i>	249
2 G-33650 <i>LASEK TREPHINE 8.0 mm, with crosshairs</i>	249	6 G-33670 <i>LOHMANN LASEK EPI PEELER</i>	64
3 G-33652 <i>LASEK TREPHINE 9.0 mm, with crosshairs</i>	249	7 G-33930 <i>TH. NEUHANN LASIK SPATULA</i>	168
4 G-33655 <i>LOHMANN LASEK FUNNEL 8.5 mm, w crosshairs</i>	249	8 G-15180 <i>IRRIGATION CANNULA bulbous tip, 26G</i>	196

LASIK - LASER-ASSISTED IN SITU KERATOMILEUSIS

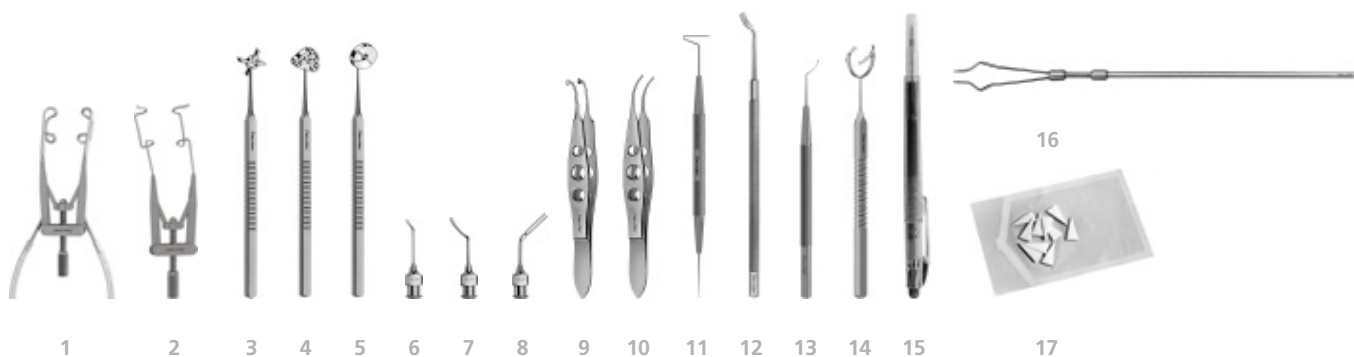

	page		page
1 G-33920 <i>KNORZ LASIK EYE SPECULUM w aspiration</i>	26	10 G-18914 <i>BURATTO LASIK FLAP FORCEPS</i>	119
2 G-15960 <i>LIEBERMAN EYE SPECULUM</i>	25	11 G-33943 <i>PFAEFFL FLAP LIFTER V-shaped lifter and hook</i>	172
3 G-33745 <i>MENDEZ LASIK CORNEAL MARKER</i>	45	12 G-33912 <i>ZIRM LASIK CORNEAL PROTECTOR</i>	168
4 G-33746 <i>CHAYET LASIK CORNEAL MARKER</i>	45	13 G-33940 <i>BLUM FEMTO-LASIK ROUND SPOON bevel up</i>	171
5 G-33747 <i>LU LASIK CORNEAL MARKER</i>	45	14 G-33759 <i>FINE-THORNTON FIXATION RING 13 mm, blunt</i>	150
6 G-33910 <i>ZIRM LASIK DISSECTOR CANNULA 25G, flat</i>	199	15 G-33786 <i>MARKING PEN gentian violet, 20 pcs./box</i>	236
7 G-33911 <i>ZIRM LASIK IRRIGATION CANNULA 20G, flat</i>	199	16 G-18150 <i>HOLDER FOR ABSORBENT STRIPS</i>	145
8 G-33909 <i>BAUER LASIK CANNULA double-armed, 25G</i>	198	17 G-18127 <i>ABSORBENT SWABS 17 mm, sterile</i>	145
9 G-33428 <i>PFAEFFL FLAPORHEXIS FORCEPS oval tips</i>	118	18 G-39526 <i>STERISAFE DURO A4 PLUS COMPLETE SET</i>	261

FEMTO LASIK

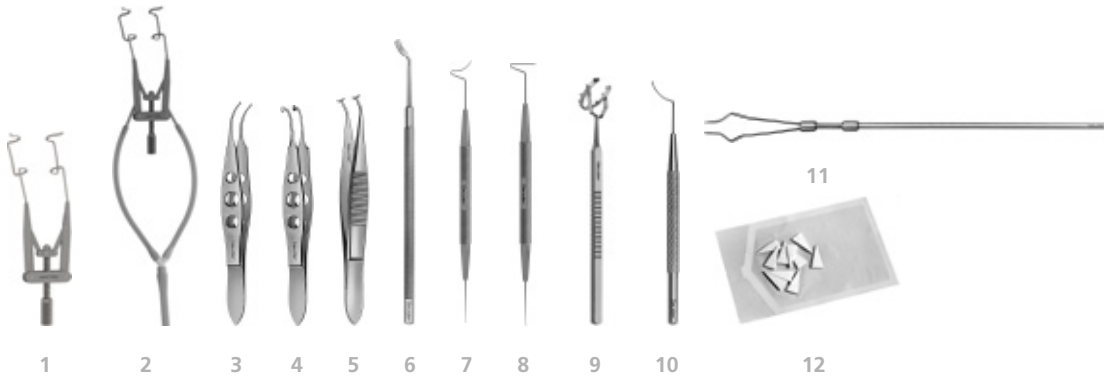

1	G-15960	<i>LIEBERMAN EYE SPECULUM</i>	25	7	G-33427	<i>PFAEFFL FLAP LIFTER</i> curved lifter and hook.....	172
2	G-15961	<i>LIEBERMAN ASPIRATION SPECULUM</i>	28	8	G-33943	<i>PFAEFFL FLAP LIFTER</i> V-shaped lifter and hook.....	172
3	G-18914	<i>BURATTO LASIK FLAP FORCEPS</i>	119	9	G-33758	<i>CLEAR-CORNEA-INCISION FIXATION RING</i>	150
4	G-33428	<i>PFAEFFL FLAPORHEXIS FORCEPS</i> oval tips.....	118	10	G-33930	<i>TH. NEUHANN LASIK SPATULA</i>	168
5	G-33429	<i>KNORZ FEMTO-LASIK FLAP FORCEPS</i> T-bar tips.....	119	11	G-18150	<i>HOLDER FOR ABSORBENT STRIPS</i>	145
6	G-33912	<i>ZIRM LASIK CORNEAL PROTECTOR</i>	168	12	G-18127	<i>ABSORBENT SWABS</i> 17 mm, sterile.....	145

RELEX® SMILE - SMALL INCISION LENTICULE EXTRACTION

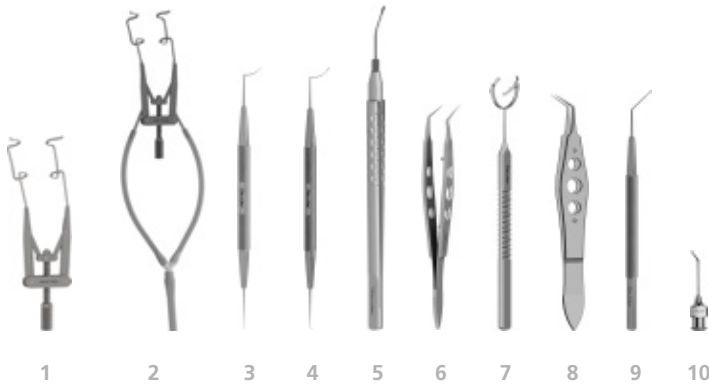

			page				page
1	G-15960	<i>LIEBERMAN EYE SPECULUM</i>	25	5	G-33960	<i>RUPAL SHAH LENTICULE MICRO FORCEPS</i>	119
2	G-15961	<i>LIEBERMAN ASPIRATION SPECULUM</i>	28	6	G-33961	<i>LENTICULE FORCEPS</i> angled to side, 7.5 mm.....	120
3	G-33952	<i>CHANSUE FEMTO DOUBLE INSTRUMENT</i> spatula/hook.....	171	7	G-33759	<i>FINE-THORNTON FIXATION RING</i> 13 mm, blunt.....	150
4	G-33950	<i>CHANSUE FEMTO DOUBLE INSTRUMENT</i> spoon-spatula/hook.....	170	8	G-33941	<i>KELMAN-MCPHERSON FRAGMENT FORCEPS</i>	108
				9	G-33959	<i>BREYER FEMTO-LASIK HOOK</i>	172
				10	G-33910	<i>ZIRM LASIK DISSECTOR CANNULA</i> 25G, flat.....	199

*ReLex® (Refractive Lenticule Extraction) is a registered trademark of Carl ZeissMeditec AG.

KERATOPLASTY

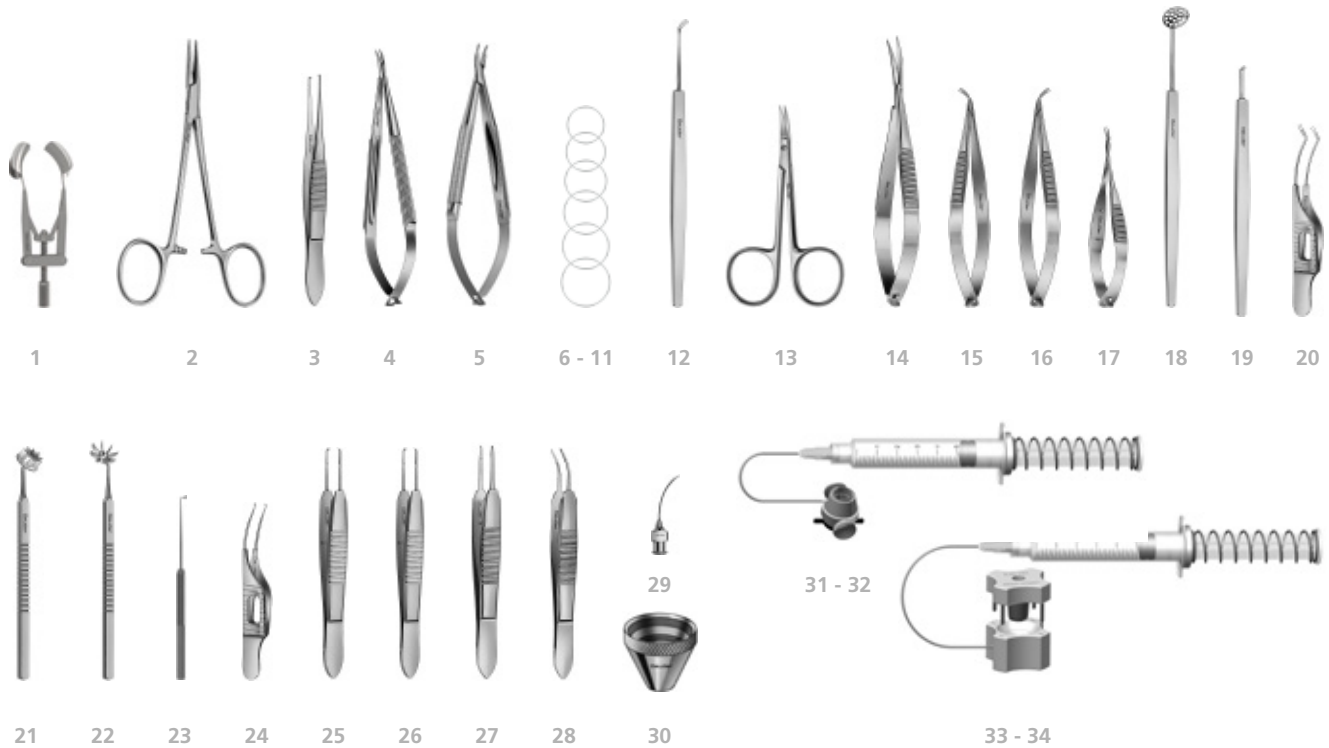

	page		page
1 G-15966 <i>KERSHNER EYE SPECULUM</i> solid blades.....	25	18 G-15758 <i>KERATOPLASTY SPATULA</i> perforated.....	164
2 G-18180 <i>HALSTEAD MOSQUITO FORCEPS</i> straight.....	135	19 G-14200 <i>PAUFIQUE KERATOPLASTY KNIFE</i>	64
3 G-18791 <i>DRESSING FORCEPS</i> 1 x 2 teeth, 0.7 mm.....	110	20 G-18972 <i>THOMAS NEUHANN KERATOPLASTY FORCEPS</i>	104
4 G-17450 <i>JACOBI NEEDLE HOLDER</i> curved, w/o lock.....	139	21 G-32229 <i>DUNCKER SUTURE MARKER</i> for 8.0 mm transplant..	42
5 G-17500 <i>BARRAQUER NEEDLE HOLDER</i> curved, w/o lock.....	139	22 G-33727 <i>THOMAS NEUHANN CORNEAL MARKER</i> 8 blades...	41
6 G-15065 <i>FLIERINGA FIXATION RING</i> 15 mm.....	151	23 G-33744 <i>SUFFO CORNEA SUTURE MARKER</i> 8 mm.....	43
7 G-15070 <i>FLIERINGA FIXATION RING</i> 16 mm.....	151	24 G-18960 <i>MICRO COLIBRI FORCEPS</i> with tying platform.....	104
8 G-15075 <i>FLIERINGA FIXATION RING</i> 17 mm.....	151	25 G-19001 <i>CASTROVIEJO SUTURING FORCEPS</i> 0.12 mm.....	103
9 G-15080 <i>FLIERINGA FIXATION RING</i> 18 mm.....	151	26 G-19010 <i>CASTROVIEJO SUTURING FORCEPS</i> 0.6 mm.....	103
10 G-15085 <i>FLIERINGA FIXATION RING</i> 19 mm.....	151	27 G-19030 <i>TUEBINGEN TYING FORCEPS</i> straight.....	106
11 G-15090 <i>FLIERINGA FIXATION RING</i> 20 mm.....	151	28 G-19040 <i>TUEBINGEN TYING FORCEPS</i> curved.....	106
12 G-14020 <i>KUHNT CORNEAL SCARIFIER</i> fig. 2.....	64	29 G-15250 <i>SAUTTER HYDRODIS. CANNULA</i> 27G, vert flat.....	194
13 G-19400 <i>BONN EYE SCISSORS</i> curved, delicate.....	92	30 G-32318 <i>MALONEY KERATOMETER</i>	46
14 G-19750 <i>WESTCOTT SCISSORS</i> blunt tips, curved, 12 cm.....	89	31 G-570750 <i>NANOEDGE VACUUM TREPHINE</i> 7.5 mm.....	218
15 G-19720 <i>KATZIN KERATOPLASTY SCISSORS</i> right, 10 cm.....	81	32 G-570800 <i>NANOEDGE VACUUM TREPHINE</i> 8.0 mm.....	218
16 G-19725 <i>KATZIN KERATOPLASTY SCISSORS</i> left, 10 cm.....	81	33 G-560800 <i>NANOEDGE VACUUM CORNEAL PUNCH</i> 8.0 mm...	218
17 G-19765 <i>VANNAS CAPSULOTOMY SCISSORS</i> curved.....	84	34 G-560850 <i>NANOEDGE VACUUM CORNEAL PUNCH</i> 8.5 mm...	218

DSEK / DSAEK - DESCOMET'S STRIPPING (AUTOMATED) ENDOTHELIAL KERATOPLASTY

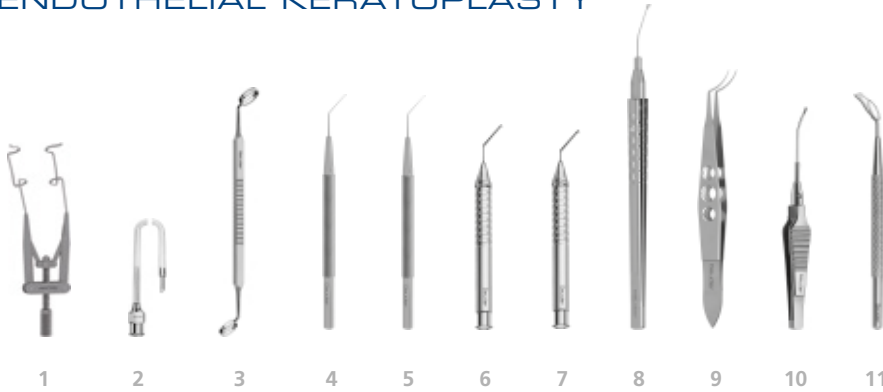

	page		page
1 G-15960 <i>LIEBERMAN EYE SPECULUM</i>	25	7 G-38602 <i>NEUHANN IRRIGATION DESCOMET SCRAPER</i>	204
2 G-33416 <i>BOPP A.C. INFUSION CANNULA</i> silicone tube.....	193	8 G-38634 <i>GERTEN DSAEK/DMEK RHEXIS FORCEPS</i> 23G.....	118
3 G-38600 <i>NEUHANN CORNEAL MARKER</i> double 8 / 9 mm.....	42	9 G-38603 <i>DSAEK IMPLANTATION FORCEPS</i>	118
4 G-38607 <i>DESCOMET INCISION HOOK</i> 0.2 mm tip.....	169	10 G-38606 <i>TH. NEUHANN DSAEK FORCEPS</i> 21G.....	118
5 G-38608 <i>DESCOMET SCRAPER</i>	169	11 G-38604 <i>TH. NEUHANN DSAEK INSERTION SPATULA</i>	169
6 G-38601 <i>ALTHAUSCARTSBURG IRRIGATION DESCOMET HOOK</i>	204		

DALK - DEEP ANTERIOR LAMELLAR KERATOPLASTY

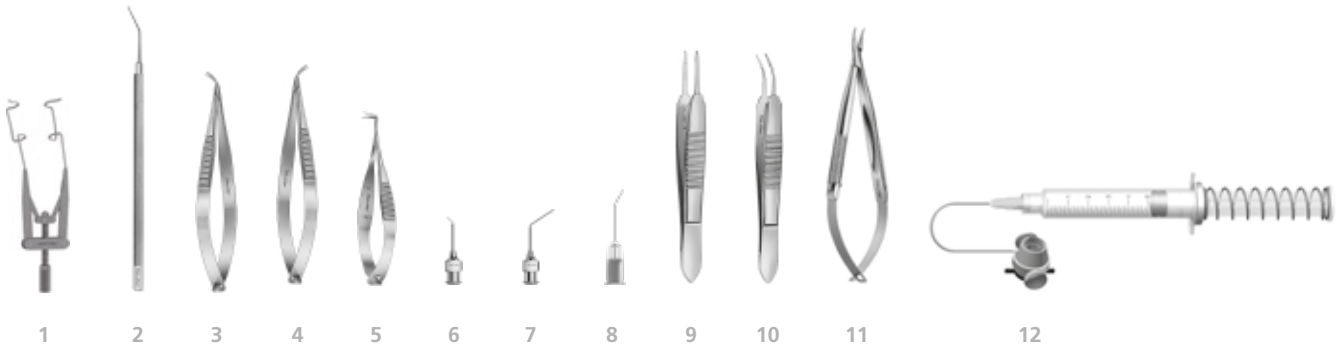

	page		page
1 G-15960 <i>LIEBERMAN EYE SPECULUM</i>	25	7 G-15312 <i>KRUMEICH CORNEAL IRRIGATION CANNULA</i> 23G..	199
2 G-32728 <i>RENTSCH SPATULA</i> tapered 0.6 to 0.3 mm.....	160	8 G-34501 <i>SINGLE-USE DALK CANNULA</i>	229
3 G-19720 <i>KATZIN KERATOPLASTY SCISSORS</i> right, 10 cm.....	81	9 G-19030 <i>TUEBINGEN TYING FORCEPS</i> straight.....	106
4 G-19725 <i>KATZIN KERATOPLASTY SCISSORS</i> left, 10 cm.....	81	10 G-19040 <i>TUEBINGEN TYING FORCEPS</i> curved.....	106
5 G-19770 <i>VANNAS CAPSULOTOMY SCISSORS</i> angled to side...84		11 G-17505 <i>BARRAQUER NEEDLE HOLDER</i> curved, w/o lock.....	139
6 G-15310 <i>KRUMEICH CORNEAL IRRIGATION CANNULA</i> 27G..	199	12 G-570800 <i>NANOEDGE VACUUM TREPHINE</i> 8.0 mm.....	218

DSEK / DSAEK · DALK

DMEK - DESCemet MEMBRANE ENDOTHELIAL KERATOPLASTY

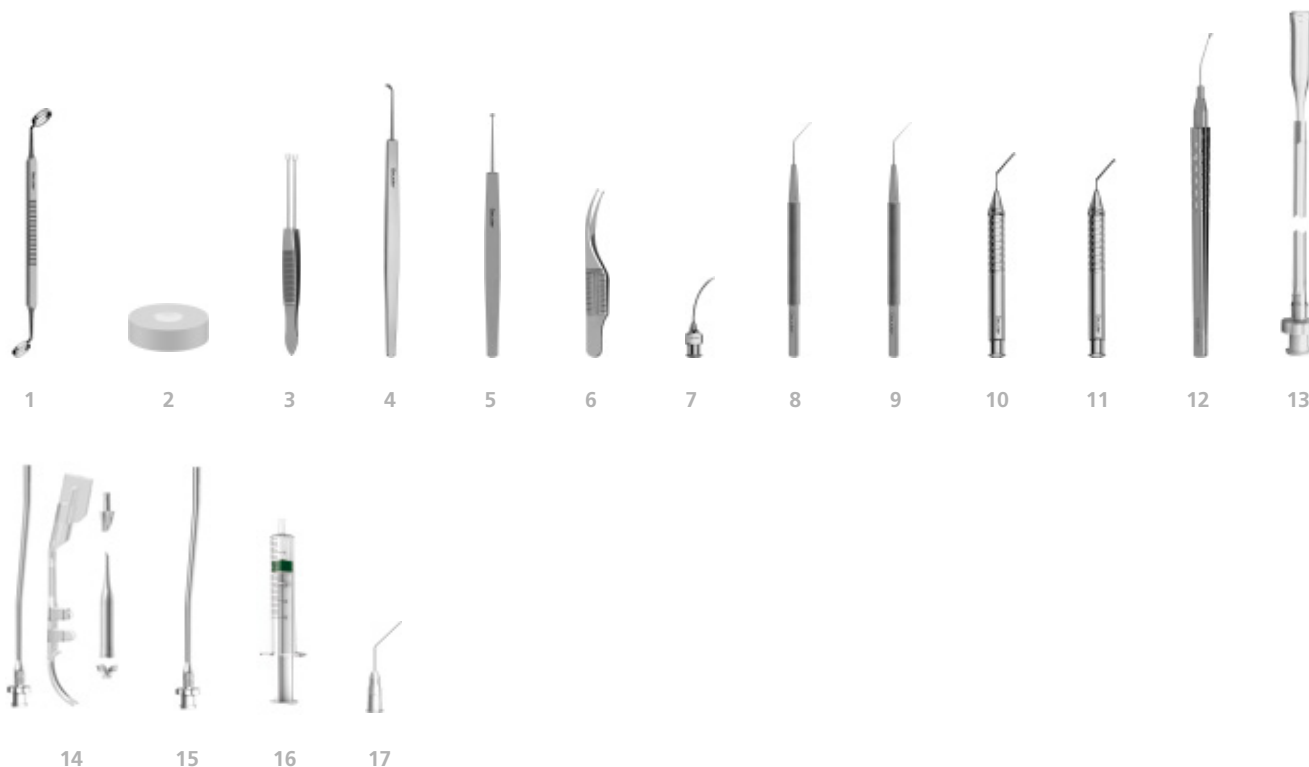

	page		page
1 G-38600 NEUHANN CORNEAL MARKER double 8 / 9 mm.....	42	10 G-38601 ALTHAUS-CARTSBURG IRRIGATION DESCemet	
2 G-38620 SZURMAN DMEK GRAFT RETAINER.....	71	HOOK	204
3 G-38623 REMKY DMEK KERATOPLASTY FORCEPS.....	105	11 G-38602 NEUHANN IRRIGATION DESCemet SCRAPER.....	204
4 G-38621 SZURMAN DMEK PREPARATION SCRAPER.....	64	12 G-38634 GERTEN DSAEK/DMEK RHESIS FORCEPS 23G.....	118
5 G-38622 SZURMAN DMEK PREPARATION SPATULA.....	169	13 G-38635 SZURMAN SINGLE-USE DMEK CARTRIDGE 1.6 mm.....	227
6 G-38624 SZURMAN DMEK PREPARATION FORCEPS.....	117	14 G-38626 SZURMAN DMEK RAPID transportation cartridge.....	227
7 G-32167 SAUTTER HYDRODIS. CANNULA 27G, horiz flat.....	194	15 G-38611 SINGLE-USE TUBING WITH LUER CONNECTOR.....	227
8 G-38607 DESCemet INCISION HOOK 0.2 mm tip.....	169	16 G-38610 SINGLE-USE SYRINGE BD Emerald, 5 ml.....	234
9 G-38608 DESCemet SCRAPER.....	169	17 G-34500 SAAD SINGLE-USE UNFOLDING CANNULA.....	229

GLAUCOMA

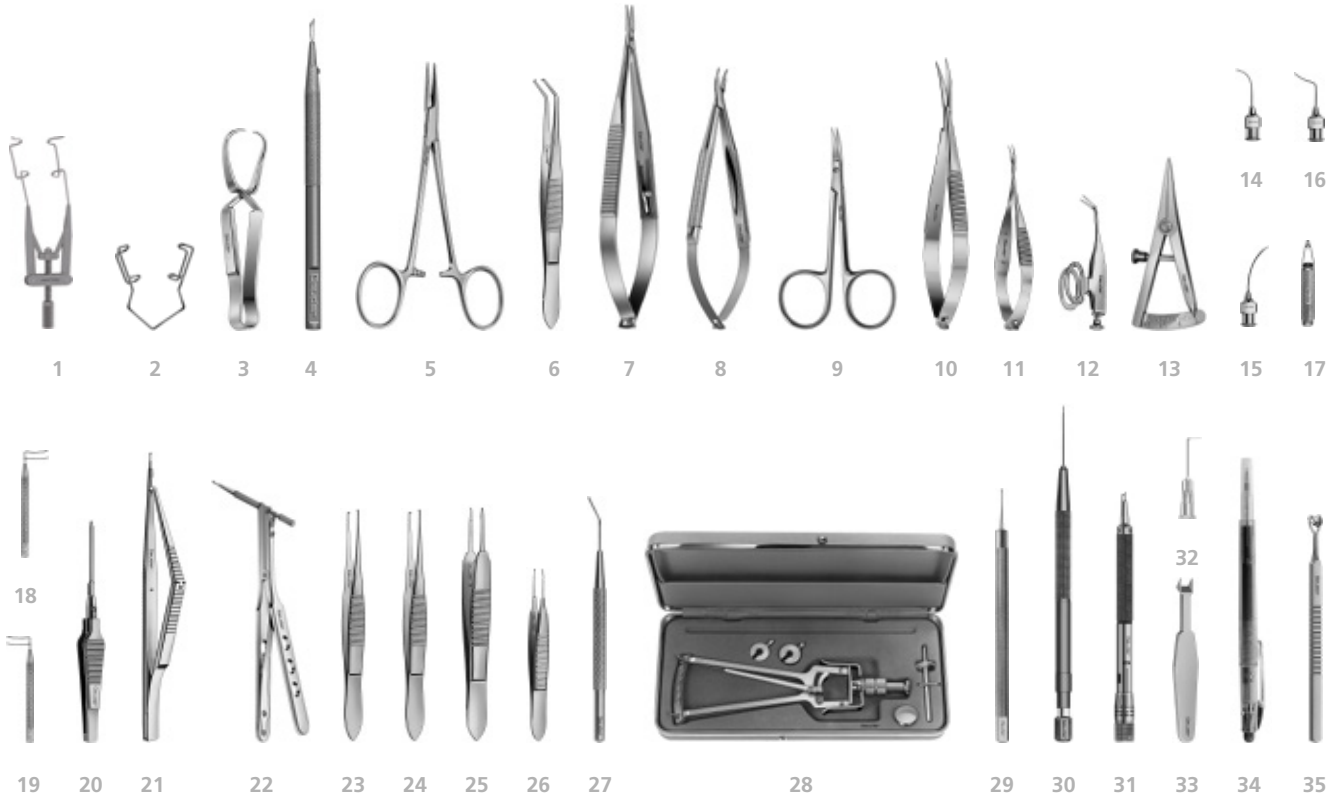

	page		page
1 G-15960 <i>LIEBERMAN EYE SPECULUM</i>	25	20 G-18235 <i>GREHN GLAUCOMA PUNCH 20G</i>	76
2 G-17020 <i>BARRAQUER EYE SPECULUM</i> fenestrated.....	15	21 G-18238 <i>KELLY DESCEMET PUNCH</i> for Glaucoma, 1.0 mm.....	76
3 G-33200 <i>SCHAEDEL TOWEL FORCEPS</i>	136	22 G-18239 <i>LUNTZ-DODICK TRABECULECTOMY PUNCH</i> 360° rotatable.....	76
4 G-34036 <i>NANOEDGE PARACENTESIS KNIFE 30°</i> straight.....	219	23 G-18791 <i>DRESSING FORCEPS</i> 1 x 2 teeth, 0.7 mm.....	110
5 G-18180 <i>HALSTEAD MOSQUITO FORCEPS</i> straight.....	135	24 G-18792 <i>DRESSING FORCEPS</i> 1 x 2 teeth, 1.0 mm.....	110
6 G-18820 <i>REMKY SUPERIOR RECTUS FORCEPS</i>	126	25 G-19030 <i>TUEBINGEN TYING FORCEPS</i> straight.....	106
7 G-17565 <i>CASTROVIEJO NEEDLE HOLDER</i> straight, w. lock.....	142	26 G-18900 <i>BONN IRIS FORCEPS</i> straight, 1 x 2 teeth.....	110
8 G-17500 <i>BARRAQUER NEEDLE HOLDER</i> curved, w/o lock.....	139	27 G-18900 <i>SPATULA</i> angled, 1.0 mm wide.....	110
9 G-19400 <i>BONN EYE SCISSORS</i> curved, delicate.....	92	28 G-19230 <i>SCHIOETZ TONOMETER</i>	48
10 G-19750 <i>WESTCOTT SCISSORS</i> blunt tips, curved, 12 cm.....	89	29 G-14105 <i>MICRO ROUND KNIFE</i> for viscocanalostomy.....	63
11 G-19630 <i>TUEBINGEN CAPSULOTOMY SCISSORS</i> curved.....	84	30 G-31487 <i>DIAMOND KNIFE</i> for viscocanalostomy.....	62
12 G-19680 <i>BARRAQUER SCISSORS</i> 7 mm blades.....	87	31 G-31470 <i>TRI-FACET DIAMOND STEP KNIFE</i>	61
13 G-19130 <i>CASTROVIEJO CALIPER</i> 15 mm.....	43	32 G-15197 <i>SINGLE-USE IRRIGATION CANNULA</i> angled, 35G.....	230
14 G-15185 <i>FRANKFURT HYDRODISSECTION CANNULA</i> 27G.....	194	33 G-32210 <i>FRONIMOPOULUS MARKER</i> U-shaped.....	44
15 G-15250 <i>SAUTTER HYDRODIS. CANNULA</i> 27G, vert flat.....	194	34 G-33786 <i>MARKING PEN</i> gentian violet, 20 pcs./box.....	236
16 G-22619 <i>PH. JACOBI TRABECULAR ASPIRATION CANNULA</i>	195	35 G-32209 <i>TOBIAS NEUHANN SCLERAL FLAP MARKER</i>	44
17 G-20612 <i>SCHMIDT-MUMM DUCT TREPHINE</i> 1.2 mm.....	69	36 G-39526 <i>STERISAFE DURO A4 PLUS COMPLETE SET</i>	261
18 G-15125 <i>HARMS TRABECULAR PROBE</i> right.....	188		
19 G-15130 <i>HARMS TRABECULAR PROBE</i> left.....	188		

EMERGENCY

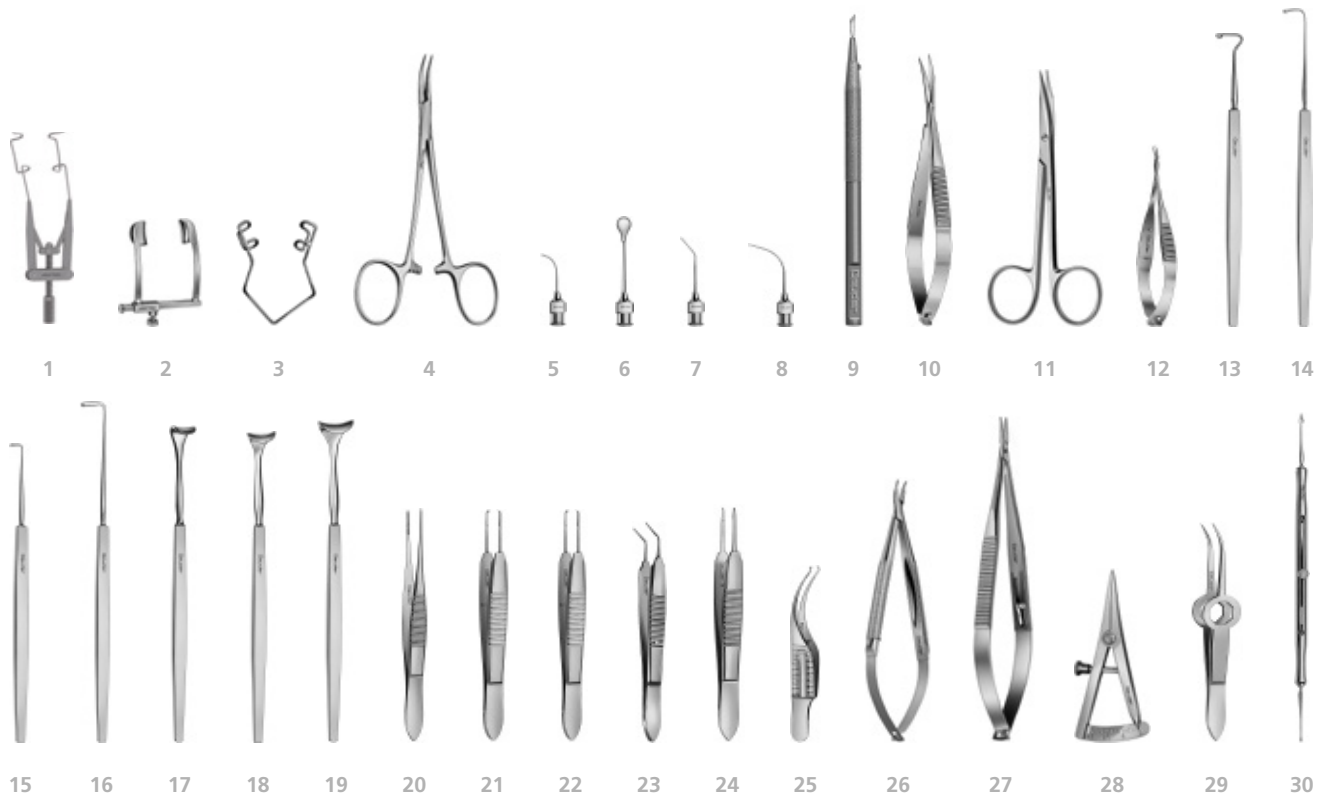

	page		page
1	25	17	35
2	23	18	35
3	15	19	35
4	135	20	110
5	194	21	103
6	193	22	103
7	191	23	107
8	191	24	106
9	219	25	104
10	89	26	139
11	89	27	142
12	84	28	43
13	175	29	101
14	174	30	55
15	174		
16	175		

ENUCLEATION

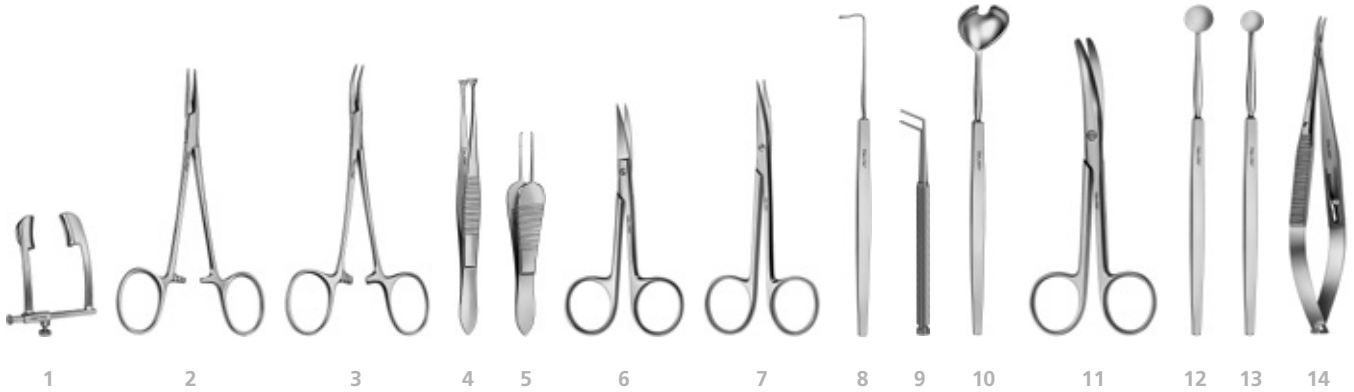

	page		page
1 G-15990 <i>COOK EYE SPECULUM</i> large.....	23	11 G-19525 ENUCLEATION SCISSORS medium curve, 13.5 cm....	94
2 G-18180 <i>HALSTEAD MOSQUITO FORCEPS</i> straight.....	135	12 G-31545 <i>BUNGE EXENTERATION CURETTE</i> medium.....	52
3 G-18181 <i>HALSTEAD MOSQUITO FORCEPS</i> curved.....	135	13 G-31555 <i>BUNGE EXENTERATION CURETTE</i> large.....	52
4 G-19050 <i>GRAEFE FIXATION FORCEPS</i> without lock.....	109	14 G-17575 <i>CASTROVIEJO NEEDLE HOLDER</i> curved, w. lock.....	142
5 G-18940 <i>PAUFIQUE UNIVERSAL SUTURING FORCEPS</i>	105	15 G-39526 STERISAFE DURO A4 PLUS COMPLETE SET	261
6 G-19375 EYE SCISSORS curved, sharp tips, 10 cm.....	91		
7 G-19485 <i>STEVENS TENOTOMY SCISSORS</i> curved, long.....	89		
8 G-15810 <i>GRAEFE STRABISMUS HOOK</i> large, 12 mm.....	174		
9 G-19112 <i>BANGERTER MUSCLE FORCEPS</i>	127		
10 G-15780 <i>WELLS ENUCLEATION SPOON</i>	168		

PTERYGIUM

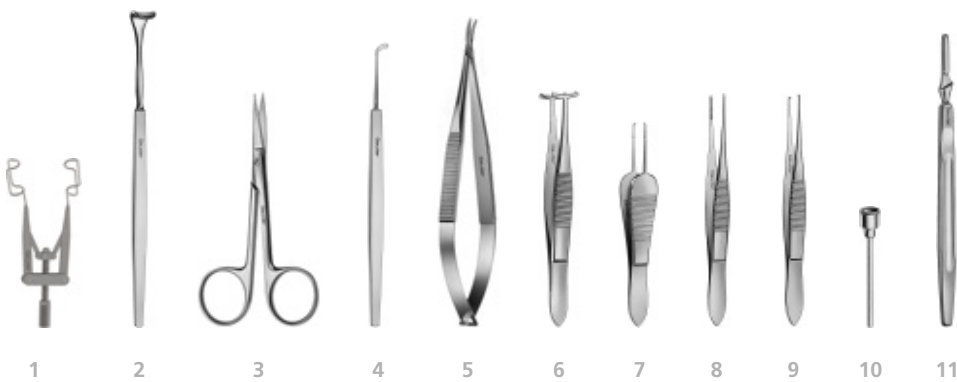

	page		page
1 G-15965 <i>KERSHNER EYE SPECULUM</i> fenestrated.....	25	7 G-18940 <i>PAUFIQUE UNIVERSAL SUTURING FORCEPS</i>	105
2 G-32120 <i>DESMARRES LID RETRACTOR</i> fig. 0.....	35	8 G-18782 DRESSING FORCEPS serrated, 1.0 mm.....	110
3 G-19355 EYE SCISSORS straight, sharp tips, 10 cm.....	91	9 G-18792 DRESSING FORCEPS 1 x 2 teeth, 1.0 mm.....	110
4 G-14010 <i>KUHNT CORNEAL SCARIFIER</i> fig. 1.....	64	10 G-18300 DIAMOND BURR 8.0 mm.....	250
5 G-17570 <i>CASTROVIEJO NEEDLE HOLDER</i> curved, w/o lock...	142	11 G-32700 SCALPEL HANDLE	236
6 G-19080 <i>BARRAQUER FIXATION FORCEPS</i>	109		

ENUCLEATION · PTERYGIUM

OFFICE SET (OPTOMETRIST)



	page		page
1 G-17020 <i>BARRAQUER EYE SPECULUM</i> fenestrated.....	15	10 G-19460 <i>STRABISMUS SCISSORS</i> short, straight.....	91
2 G-17025 <i>BARRAQUER EYE SPECULUM</i> infants, fenestrated.....	15	11 G-32715 <i>SCHOCKET SCLERAL DEPRESSOR</i>	182
3 G-18975 <i>BARRAQUER SUTURE REMOVING FORCEPS</i>	104	12 G-15870 <i>MEYHOEFFER CHALAZION CURETTE</i> 2 mm.....	51
4 G-19765 <i>VANNAS CAPSULOTOMY SCISSORS</i> curved.....	84	13 G-18680 <i>LAMBERT CHALAZION FORCEPS</i>	134
5 G-18750 <i>BARRAQUER CILIA FORCEPS</i>	101	14 G-31105 <i>EYE SHIELD</i> plastic, transparent, 100 pcs.....	251
6 G-14550 <i>FOREIGN BODY INSTRUMENT</i> needle/spud.....	55	15 G-15230 <i>BONN IRRIGATION CANNULA</i> delicate.....	196
7 G-18850 <i>SHAAF CILIA AND FOREIGN BODY FORCEPS</i>	101	16 G-32665 <i>SILICONE BULB</i> 20 ml.....	214
8 G-150401 <i>WILDER LACRIMAL PROBE</i> slim, long taper.....	185	17 G-32920 <i>JAMESON STRABISMUS HOOK</i> 11 mm.....	175
9 G-32120 <i>DESMARRES LID RETRACTOR</i> fig. 0.....	35	18 G-39526 <i>STERISAFE DURO A4 PLUS COMPLETE SET</i>	261

CHALAZION

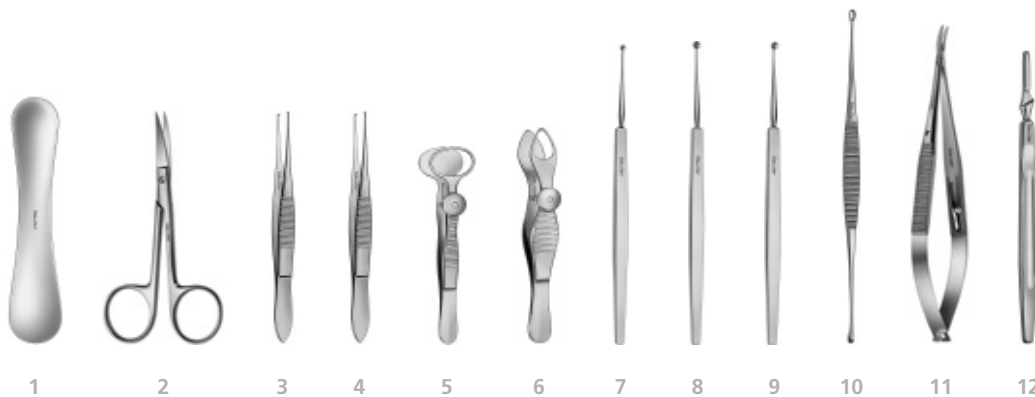

	page		page
1 G-17040 <i>JAEGER LID PLATE</i> stainless steel.....	36	8 G-15875 <i>MEYHOEFFER CHALAZION CURETTE</i> 2.5 mm.....	51
2 G-19375 <i>EYE SCISSORS</i> curved, sharp tips, 10 cm.....	91	9 G-15880 <i>MEYHOEFFER CHALAZION CURETTE</i> 3.0 mm.....	51
3 G-18791 <i>DRESSING FORCEPS</i> 1 x 2 teeth, 0.7 mm.....	110	10 G-15910 <i>AXENFELD CHALAZION CURETTE</i>	52
4 G-18792 <i>DRESSING FORCEPS</i> 1 x 2 teeth, 1.0 mm.....	110	11 G-17575 <i>CASTROVIEJO NEEDLE HOLDER</i> curved, w. lock.....	142
5 G-18685 <i>DESMARRES CHALAZION FORCEPS</i> 20 mm.....	134	12 G-32700 <i>SCALPEL HANDLE</i>	236
6 G-18710 <i>LORDAN CHALAZION FORCEPS</i> triangular.....	134		
7 G-15870 <i>MEYHOEFFER CHALAZION CURETTE</i> 2.0 mm.....	51		

LID / PTOSIS

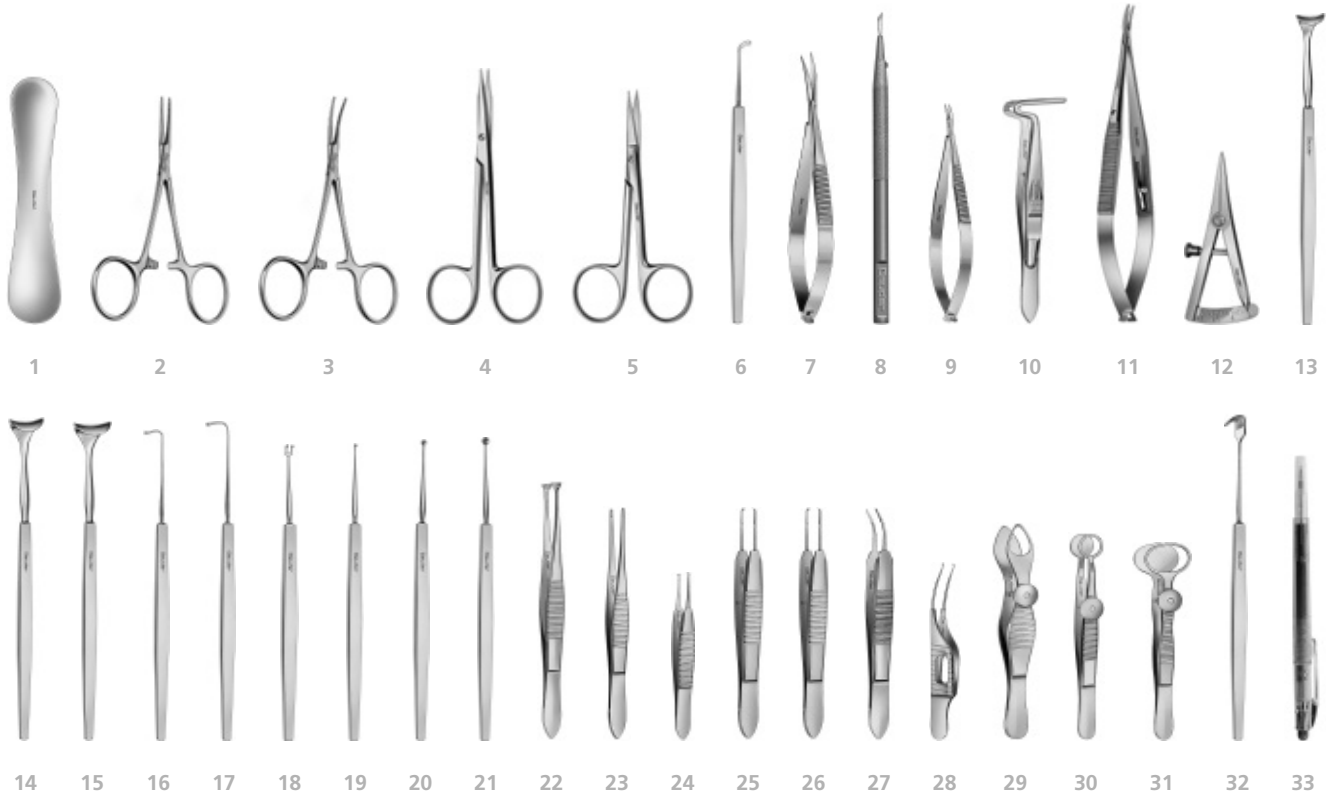

	page		page
1 G-17040 <i>JAEGER LID PLATE</i> stainless steel.....	36	18 G-15355 <i>GUTHRIE RETRACTOR</i> sharp, large.....	38
2 G-18170 <i>HARTMANN MOSQUITO FORCEPS</i> straight.....	135	19 G-15900 <i>MEYHOEFER CHALAZION CURETTE</i> 1.0 mm.....	51
3 G-18171 <i>HARTMANN MOSQUITO FORCEPS</i> curved.....	135	20 G-15870 <i>MEYHOEFER CHALAZION CURETTE</i> 2.0 mm.....	51
4 G-19480 <i>STEVENS TENOTOMY SCISSORS</i> straight, long.....	89	21 G-15875 <i>MEYHOEFER CHALAZION CURETTE</i> 2.5 mm.....	51
5 G-19355 <i>EYE SCISSORS</i> straight, sharp tips, 10 cm.....	91	22 G-19050 <i>GRAEFE FIXATION FORCEPS</i> without lock.....	109
6 G-14010 <i>KUHNT CORNEAL SCARIFIER</i> fig. 1.....	64	23 G-18810 <i>DRAEGER CONJUNCTIVA FORCEPS</i> atraumatic.....	102
7 G-19750 <i>WESTCOTT SCISSORS</i> blunt tips, curved, 12 cm.....	89	24 G-31953 <i>IRIS FORCEPS</i> straight, 1 x 2 teeth, strong.....	111
8 G-34026 <i>NANOEDGE PARACENTESIS KNIFE 15°</i> straight ...	219	25 G-19005 <i>CASTROVIEJO SUTURING FORCEPS</i> 0.3 mm.....	103
9 G-19600 <i>CORNEAL SCISSORS</i> light curve, sharp tips.....	82	26 G-19010 <i>CASTROVIEJO SUTURING FORCEPS</i> 0.6 mm.....	103
10 G-18715 <i>BERKE PTOSIS FORCEPS</i>	134	27 G-19040 <i>TUEBINGEN TYING FORCEPS</i> curved.....	106
11 G-17575 <i>CASTROVIEJO NEEDLE HOLDER</i> curved, w. lock.....	142	28 G-18960 <i>MICRO COLIBRI FORCEPS</i> with tying platform.....	104
12 G-19130 <i>CASTROVIEJO CALIPER</i> 15 mm.....	43	29 G-18710 <i>LORDAN CHALAZION FORCEPS</i> triangular.....	134
13 G-16060 <i>DESMARRES LID RETRACTOR</i> fig. 1.....	35	30 G-18680 <i>LAMBERT CHALAZION FORCEPS</i>	134
14 G-16065 <i>DESMARRES LID RETRACTOR</i> fig. 2.....	35	31 G-18685 <i>DESMARRES CHALAZION FORCEPS</i> 20 mm.....	134
15 G-16070 <i>DESMARRES LID RETRACTOR</i> fig. 3.....	36	32 G-15542 <i>AXENFELD LACRIMAL SAC RETRACTOR</i>	37
16 G-15800 <i>GRAEFE STRABISMUS HOOK</i> small, 8 mm.....	174	33 G-33786 <i>MARKING PEN</i> gentian violet, 20 pcs./box.....	236
17 G-15805 <i>GRAEFE STRABISMUS HOOK</i> medium, 10 mm.....	174		

DCR / LACRIMAL

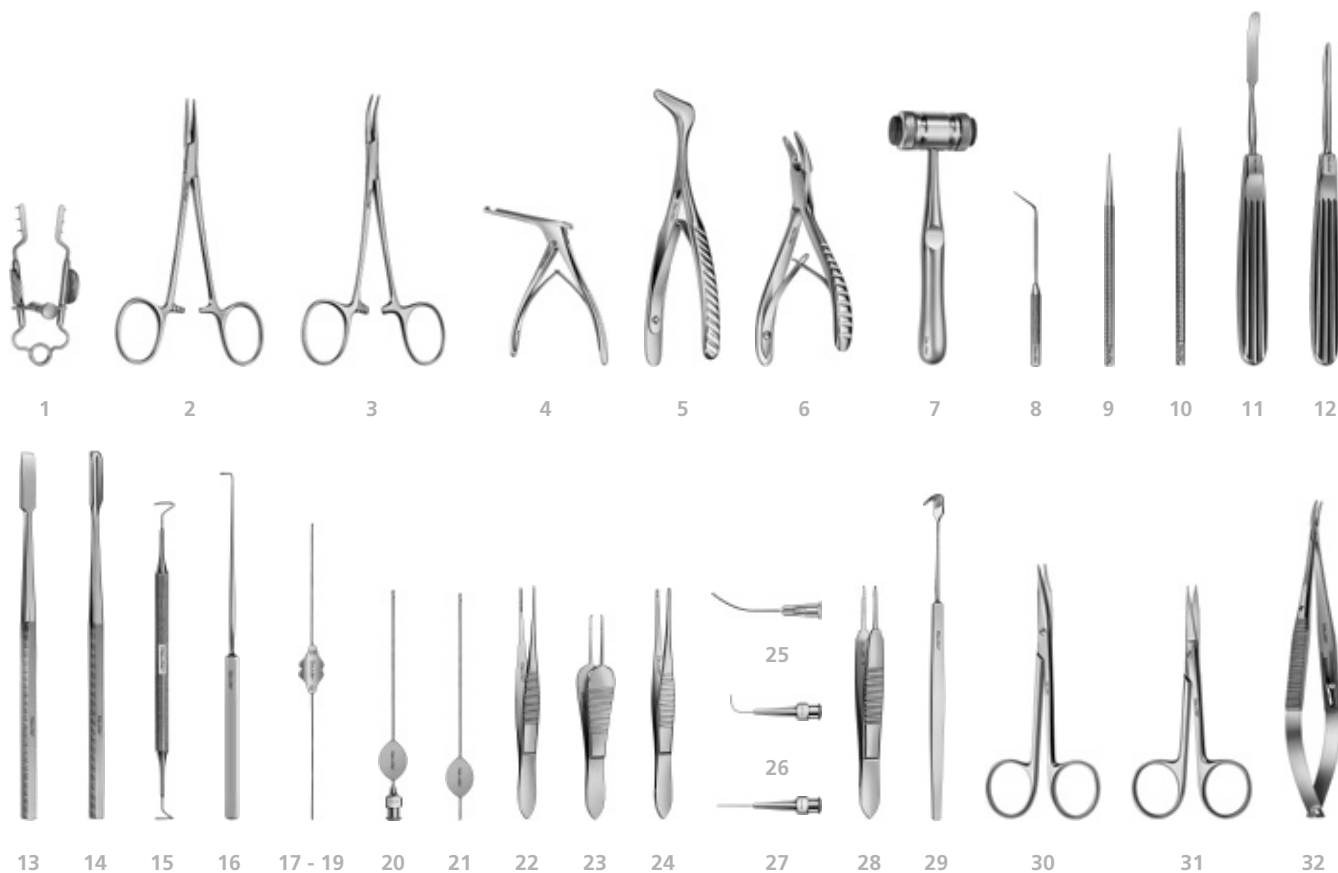

	page		page
1 G-17070 MUELLER LACRIMAL SAC RETRACTOR.....	38	18 G-150102 BOWMAN LACRIMAL PROBE size 00/0.....	187
2 G-18180 HALSTEAD MOSQUITO FORCEPS straight.....	135	19 G-150103 BOWMAN LACRIMAL PROBE size 1/2.....	187
3 G-18181 HALSTEAD MOSQUITO FORCEPS curved.....	135	20 G-33198 JUENEMANN LACRIMAL PROBE CANNULA.....	192
4 G-18225 KERRISON BONE NIBBLING RONGEUR.....	75	21 G-33194 JUENEMANN LACRIMAL PROBE 0.8 mm, w grip plate.....	188
5 G-32355 NASAL SPECULUM.....	248	22 G-18782 DRESSING FORCEPS serrated, 1.0 mm.....	110
6 G-31810 FRIEDMANN RONGEUR.....	248	23 G-18940 PAUFIQUE UNIVERSAL SUTURING FORCEPS.....	105
7 G-33125 MEAD HAMMER length 19 cm, 300 g.....	248	24 G-18810 DRAEGER CONJUNCTIVA FORCEPS atraumatic.....	102
8 G-15020 GIESSEN LACRIMAL PROBE angled.....	185	25 G-34290 SINGLE-USE LACRIMAL CANNULA curved, 26G.....	228
9 G-150401 WILDER LACRIMAL PROBE slim, long taper.....	185	26 G-15190 ANEL LACRIMAL CANNULA straight, 23G.....	191
10 G-150302 WILDER LACRIMAL PROBE medium.....	185	27 G-15195 ANEL LACRIMAL CANNULA round curve, 23G.....	191
11 G-18620 HEIDELBERG RASPATORY.....	248	28 G-19030 TUEBINGEN TYING FORCEPS straight.....	106
12 G-18630 HEIDELBERG ELEVATORIUM.....	248	29 G-15542 AXENFELD LACRIMAL SAC RETRACTOR.....	37
13 G-18240 BONE CHISEL flat, 5.0 mm wide.....	249	30 G-19485 STEVENS TENOTOMY SCISSORS curved, long.....	89
14 G-18245 BONE CHISEL hollow, 5.0 mm wide.....	249	31 G-19355 EYE SCISSORS straight, sharp tips, 10 cm.....	91
15 G-15095 PIGTAIL PROBE with suture holes.....	186	32 G-17575 CASTROVIEJO NEEDLE HOLDER curved, w. lock.....	142
16 G-32726 MUENSTER SUTURE HOOK.....	173		
17 G-150101 BOWMAN LACRIMAL PROBE size 0000/000.....	187		

STRABISMUS / MUSCLE

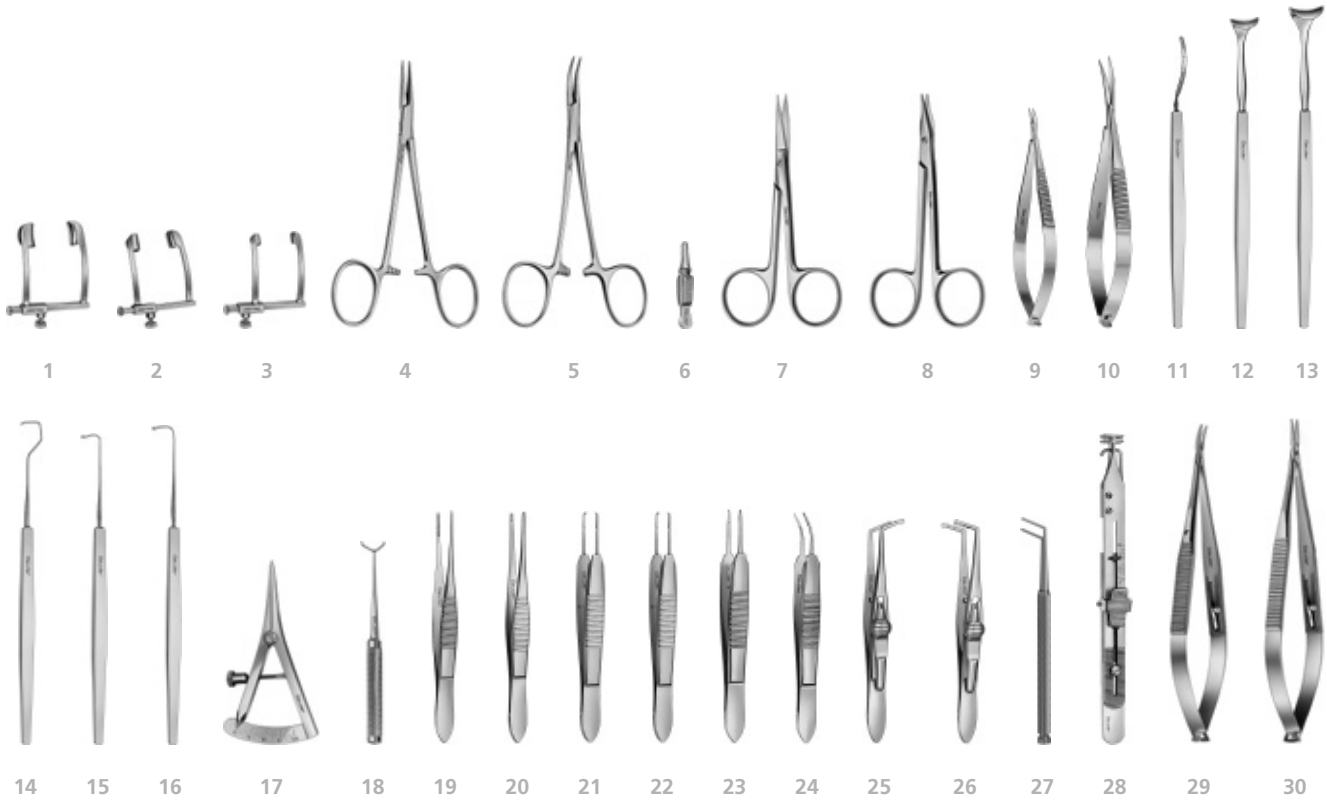

		page			page
1	G-15995 COOK EYE SPECULUM medium, 11 mm.....	23	16	G-15805 GRAEFE STRABISMUS HOOK medium, 10 mm.....	174
2	G-16000 COOK EYE SPECULUM small, 8 mm.....	24	17	G-19135 CASTROVIEJO CALIPER 20 mm.....	43
3	G-32128 COOK EYE SPECULUM infants, 5 mm.....	24	18	G-15797 FINK MARKER for 9 mm recession.....	45
4	G-18180 HALSTEAD MOSQUITO FORCEPS straight.....	135	19	G-18782 DRESSING FORCEPS serrated, 1.0 mm.....	110
5	G-18181 HALSTEAD MOSQUITO FORCEPS curved.....	135	20	G-18810 DRAEGER CONJUNCTIVA FORCEPS atraumatic.....	102
6	G-18190 DIEFFENBACH SERREFINE straight, 35 mm.....	136	21	G-19010 CASTROVIEJO SUTURING FORCEPS 0.6 mm.....	103
7	G-19355 EYE SCISSORS straight, sharp tips, 10 cm.....	91	22	G-19005 CASTROVIEJO SUTURING FORCEPS 0.3 mm.....	103
8	G-19475 STEVENS TENOTOMY SCISSORS curved, short.....	89	23	G-19030 TUEBINGEN TYING FORCEPS straight.....	106
9	G-19600 CORNEAL SCISSORS light curve, sharp tips.....	82	24	G-19040 TUEBINGEN TYING FORCEPS curved.....	106
10	G-19750 WESTCOTT SCISSORS blunt tips, curved, 12 cm.....	89	25	G-19120 SATTLER MUSCLE FORCEPS w. slide lock, right.....	127
11	G-32225 VOGT SCLERAL RULER	44	26	G-19125 SATTLER MUSCLE FORCEPS w. slide lock, left.....	127
12	G-16060 DESMARRES LID RETRACTOR fig. 1.....	35	27	G-19112 BANGERTER MUSCLE FORCEPS	127
13	G-16065 DESMARRES LID RETRACTOR fig. 2.....	35	28	G-19137 CUEPPERS STRABISMUS MUSCLE TUCKER	173
14	G-15830 MALBRAN STRABISMUS HOOK	175	29	G-17575 CASTROVIEJO NEEDLE HOLDER curved, w. lock....	142
15	G-15800 GRAEFE STRABISMUS HOOK small, 8 mm.....	174	30	G-17565 CASTROVIEJO NEEDLE HOLDER straight, w. lock....	142

RETINAL DETACHMENT

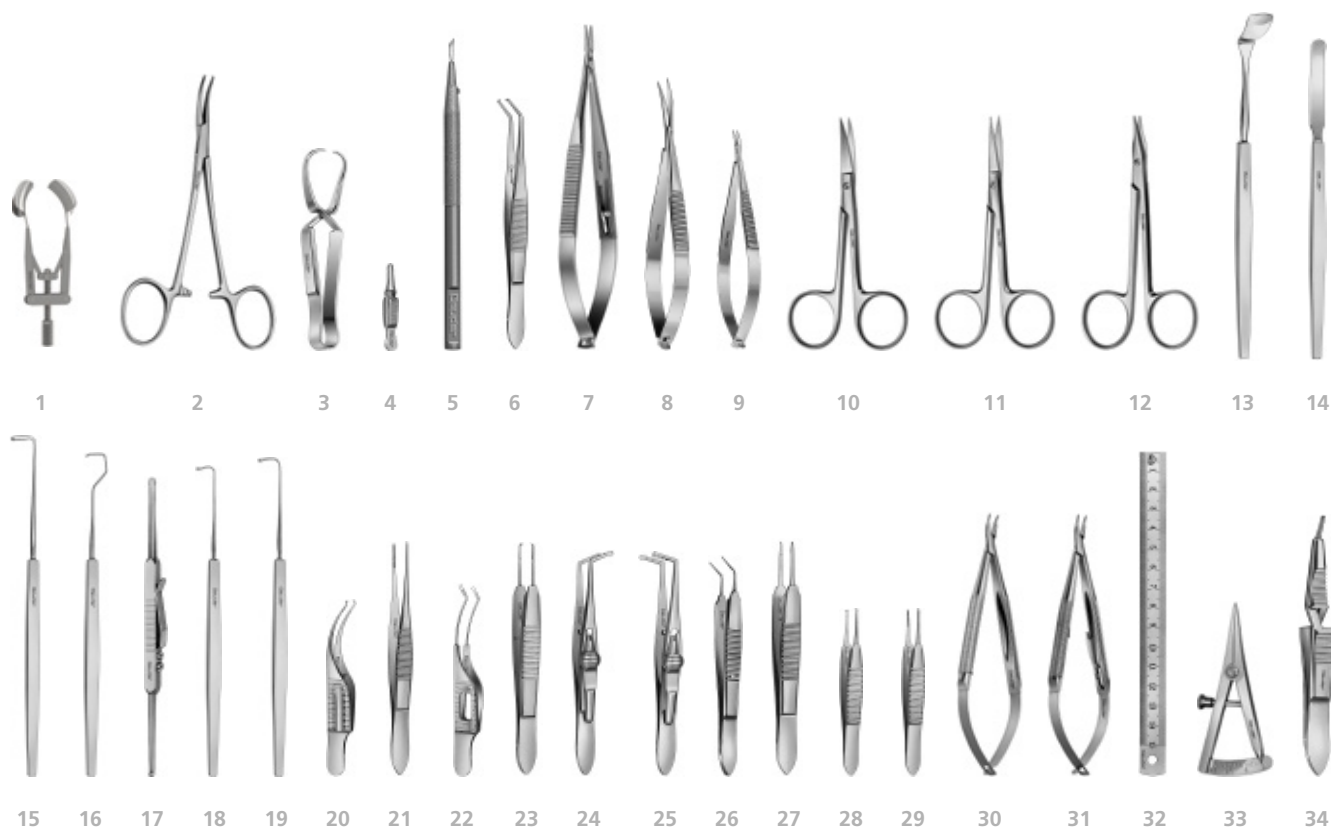

	page		page
1 G-15966 <i>KERSHNER EYE SPECULUM</i> solid blades.....	25	18 G-15800 <i>GRAEFE STRABISMUS HOOK</i> small, 8 mm.....	174
2 G-18182 <i>HALSTEAD MOSQUITO FORCEPS</i> curved, 1 x 2 teeth.....	135	19 G-15805 <i>GRAEFE STRABISMUS HOOK</i> medium, 10 mm.....	174
3 G-33200 <i>SCHAEDEL TOWEL FORCEPS</i>	136	20 G-18950 <i>COLIBRI FORCEPS</i> with tying platform.....	104
4 G-18190 <i>DIEFFENBACH SERREFINE</i> straight, 35 mm.....	136	21 G-18782 <i>DRESSING FORCEPS</i> serrated, 1.0 mm.....	110
5 G-34026 <i>NANOEDGE PARACENTESIS KNIFE 15°</i> straight.....	219	22 G-18792 <i>DRESSING FORCEPS</i> 1 x 2 teeth, 1.0 mm.....	110
6 G-18820 <i>REMKY SUPERIOR RECTUS FORCEPS</i>	126	23 G-19005 <i>CASTROVIEJO SUTURING FORCEPS</i> 0.3 mm.....	103
7 G-17565 <i>CASTROVIEJO NEEDLE HOLDER</i> straight, w. lock.....	142	24 G-19120 <i>SATTLER MUSCLE FORCEPS</i> w slide lock, right.....	127
8 G-19750 <i>WESTCOTT SCISSORS</i> blunt tips, curved, 12 cm.....	89	25 G-19125 <i>SATTLER MUSCLE FORCEPS</i> w slide lock, left.....	127
9 G-19600 <i>CORNEAL SCISSORS</i> light curve, sharp tips.....	82	26 G-19032 <i>TYING FORCEPS</i> angled, 7.5 mm.....	107
10 G-19375 <i>EYE SCISSORS</i> curved, sharp tips, 10 cm.....	91	27 G-19030 <i>TUEBINGEN TYING FORCEPS</i> straight.....	106
11 G-19355 <i>EYE SCISSORS</i> straight, sharp tips, 10 cm.....	91	28 G-31953 <i>IRIS FORCEPS</i> straight, 1 x 2 teeth, strong.....	111
12 G-19475 <i>STEVENS TENOTOMY SCISSORS</i> curved, short.....	89	29 G-18855 <i>IRIS FORCEPS</i> straight, serrated.....	110
13 G-32445 <i>HAMBURG ORBITAL SPATULA</i> 18 x 12 mm.....	163	30 G-17500 <i>BARRAQUER NEEDLE HOLDER</i> curved, w/o lock.....	139
14 G-15720 <i>BANGERTER SPATULA</i> 6 mm wide.....	163	31 G-17501 <i>BARRAQUER NEEDLE HOLDER</i> curved, w. lock.....	139
15 G-15821 <i>BONN STRABISMUS HOOK</i> 1.0 mm hole.....	175	32 G-18650 <i>RULER</i> 150 mm, 0.5 mm increments.....	44
16 G-15830 <i>MALBRAN STRABISMUS HOOK</i>	175	33 G-19130 <i>CASTROVIEJO CALIPER</i> 15 mm.....	43
17 G-32150 <i>LAQUA SCLERAL DEPRESSOR</i> double-ended.....	181	34 G-33752 <i>WATZKE SPREADING FORCEPS</i>	129

VITRECTOMY 20G

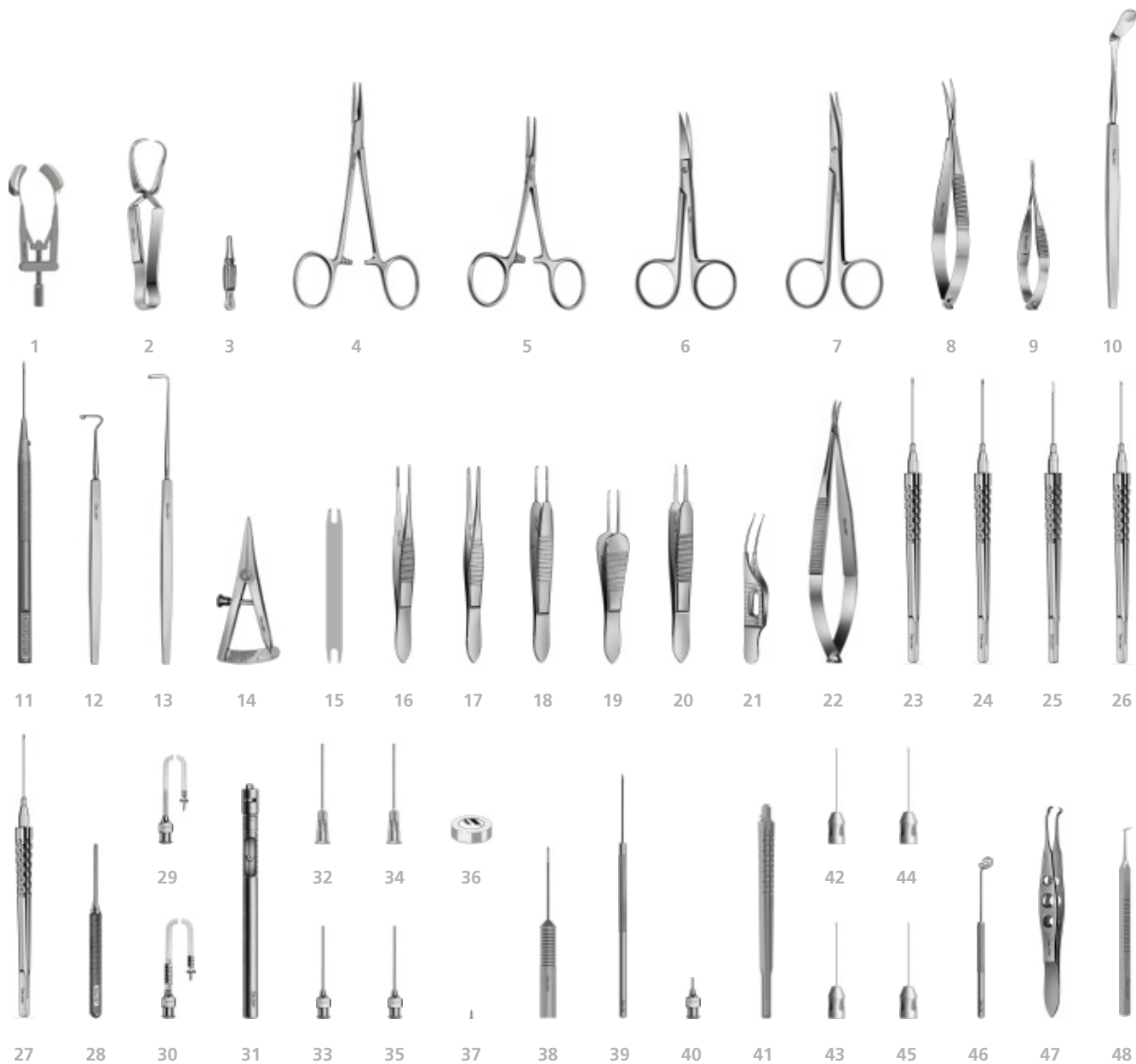

VITRECTOMY 20G

	page		page
1	25	29	211
2	136	30	211
3	136	31	208
4	135	32	231
5	135	33	209
6	91	34	231
7	89	35	209
8	89	36	250
9	84	37	128
10	164	38	176
11	219	39	177
12	175	40	212
13	175	41	221
14	43	42	222
15	43	43	221
16	110	44	222
17	102	45	222
18	103	46	150
19	105	47	129
20	106	48	176
21	104	49	255
22	142	50	255
23	130	51	256
24	130	52	255
25	130		
26	95		
27	95		
28	251		

VITRECTOMY 23G

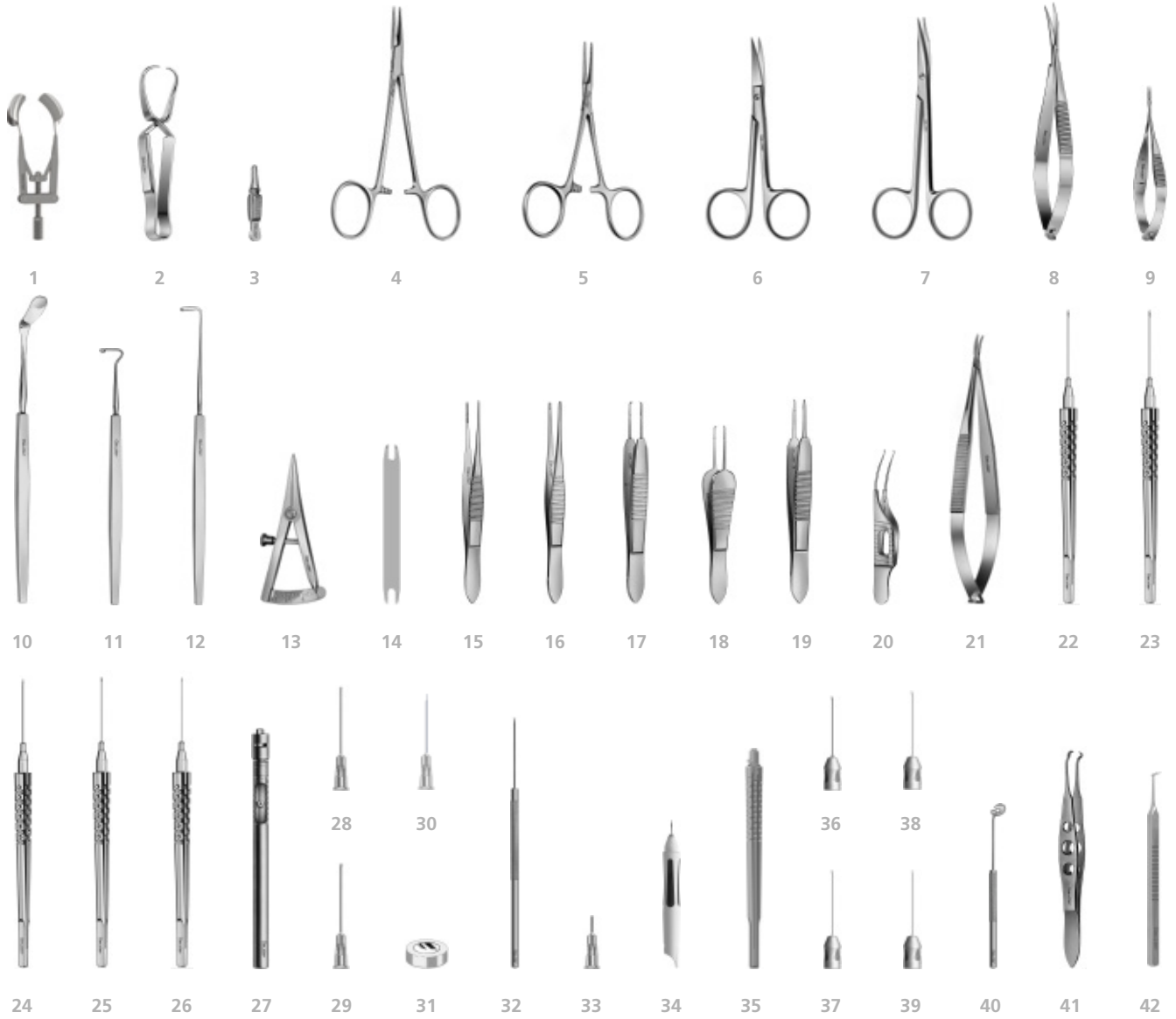

VITRECTOMY 23G

	page		page
1	25	26	96
2	136	27	208
3	136	28	231
4	135	29	231
5	135	30	232
6	91	31	250
7	89	32	177
8	89	33	232
9	84	34	225
10	164	35	221
11	175	36	221
12	175	37	222
13	43	38	222
14	43	39	222
15	110	40	150
16	102	41	129
17	103	42	176
18	105	43	255
19	106	44	255
20	104	45	256
21	142	46	255
22	132		
23	132		
24	132		
25	96		

VITRECTOMY 25G

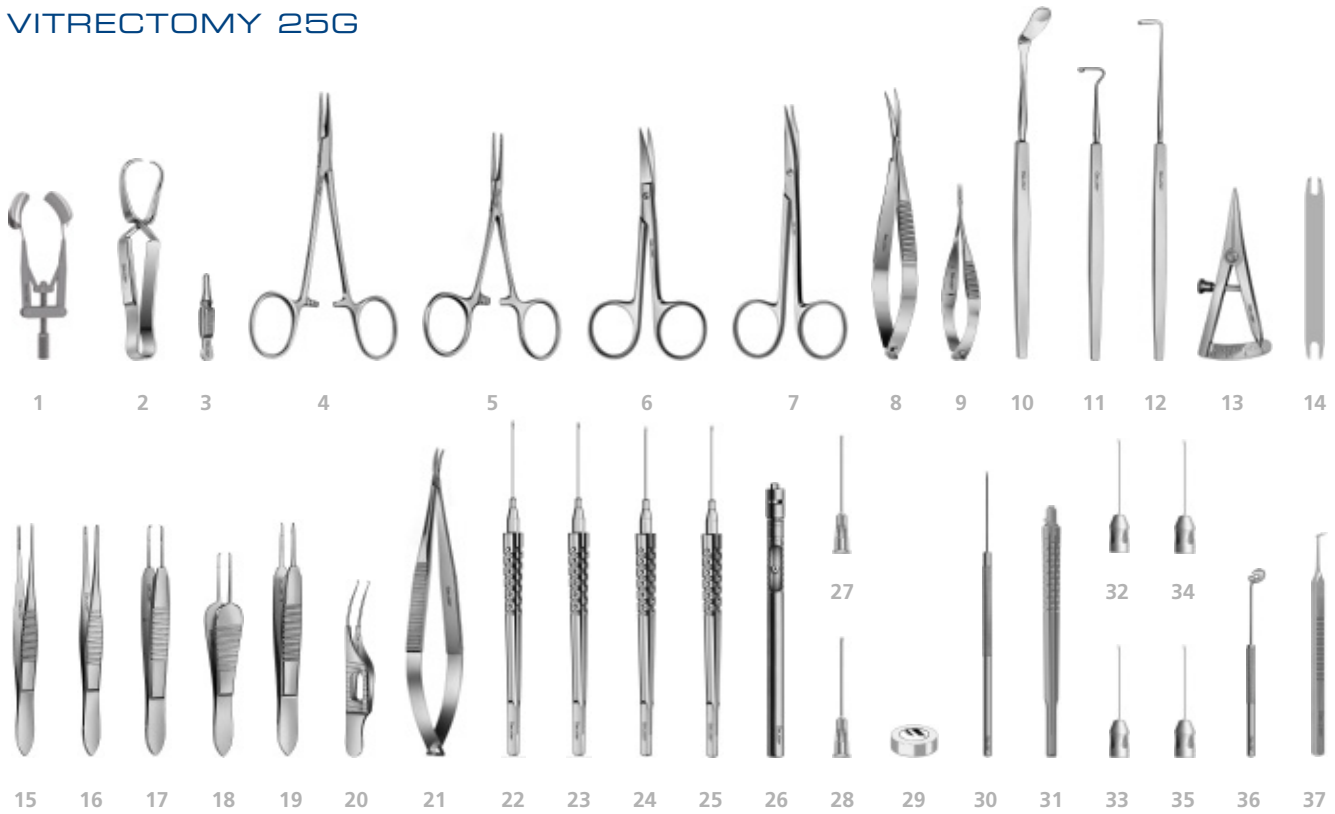

		page			page
1	G-15966 <i>KERSHNER EYE SPECULUM</i> solid blades.....	25	22	G-36312 <i>VITREORETINAL FORCEPS</i> endgripping, 25G.....	132
2	G-33200 <i>SCHAEDEL TOWEL FORCEPS</i>	136	23	G-36322 <i>VITREORETINAL FORCEPS</i> crocodile, 25G.....	132
3	G-18190 <i>DIEFFENBACH SERREFINE</i> straight, 35 mm.....	136	24	G-36366 <i>TANO VITREORETINAL FORCEPS</i> serrated, 25G.....	132
4	G-18180 <i>HALSTEAD MOSQUITO FORCEPS</i> straight.....	135	25	G-36586 <i>HEIMANN VITREORETINAL SCISSORS</i> straight, 25G.....	96
5	G-18170 <i>HARTMANN MOSQUITO FORCEPS</i> straight.....	135	26	G-37002 <i>BACKFLUSH HANDPIECE</i> with silicone chamber.....	208
6	G-19375 <i>EYE SCISSORS</i> curved, sharp tips, 10 cm.....	91	27	G-34299 <i>SINGLE-USE BACKFLUSH CANNULA</i> 25G.....	231
7	G-19485 <i>STEVENS TENOTOMY SCISSORS</i> curved, long.....	89	28	G-34297 <i>SINGLE-USE BACKFLUSH CANNULA</i> 25G w brush.....	231
8	G-19750 <i>WESTCOTT SCISSORS</i> blunt tips, curved, 12 cm.....	89	29	G-36000 <i>KILP LENS</i> 60 D flat, field of vision 20°.....	250
9	G-19760 <i>VANNAS CAPSULOTOMY SCISSORS</i> straight.....	84	30	G-37513 <i>MEMBRANE PEELER</i> 0.4 mm, recessed, angled, 25G.....	177
10	G-32446 <i>ORBITAL SPATULA</i> 18 x 8 mm.....	164	31	G-40006 <i>HANDLE UNO C</i> 6 mm, titanium.....	221
11	G-32920 <i>JAMESON STRABISMUS HOOK</i> 11 mm.....	175	32	G-42561 <i>UNO C VITREOUS SCISSORS</i> 25G, straight.....	221
12	G-15821 <i>BONN STRABISMUS HOOK</i> 1.0 mm hole.....	175	33	G-46541 <i>UNO C VITREOUS FORCEPS ENDGRIPPING</i> 25G.....	222
13	G-19130 <i>CASTROVIEJO CALIPER</i> 15 mm.....	43	34	G-46542 <i>HATTENBACH UNO C VITREOUS FORCEPS</i> 25G wave design.....	222
14	G-37410 <i>MARKING INSTRUMENT</i>	43	35	G-42544 <i>TANO UNO C FORCEPS</i> 25G.....	222
15	G-18782 <i>DRESSING FORCEPS</i> serrated, 1.0 mm.....	110	36	G-37425 <i>FIXATION INSTRUMENT</i> for trocar systems.....	150
16	G-18810 <i>DRAEGER CONJUNCTIVA FORCEPS</i> atraumatic.....	102	37	G-37435 <i>HATTENBACH HORSESHOE-HOOK</i>	176
17	G-19010 <i>CASTROVIEJO SUTURING FORCEPS</i> 0.6 mm.....	103	38	G-39786 <i>MICROSTOP® TRAY MINI</i> low, with lid.....	255
18	G-18940 <i>PAUFIQUE UNIVERSAL SUTURING FORCEPS</i>	105	39	G-39783 <i>MICROSTOP® TRAY MINI</i> low, without lid.....	255
19	G-19030 <i>TUEBINGEN TYING FORCEPS</i> straight.....	106	40	G-39782 <i>MICROSTOP® RETAINER ELEMENT</i> low.....	256
20	G-18960 <i>MICRO COLIBRI FORCEPS</i> with tying platform.....	104	41	G-39750 <i>MICROSTOP® CONTAINER HIGH</i> for two trays.....	255
21	G-17570 <i>CASTROVIEJO NEEDLE HOLDER</i> curved, w/o lock.....	142			

VITRECTOMY 25G

IN

INDEX

Geuder[®]
Precision made in Germany

ITEM NO.	PAGE	ITEM NO.	PAGE	ITEM NO.	PAGE	ITEM NO.	PAGE
G-12 ...		15180	196, 277	15740	163	16070	36, 286
12200	66	15185	194, 272, 282-283	15750	163	16075	36
12220	66	15188	195	15755	167	16080	35
12230	66	15189	195	15757	168	16105	193
12233	66	15190	191, 287	15758	164, 279	16106	196, 272, 274
12235	66	15195	191, 287	15780	168, 284	16115	195, 272
		15197	230, 282	15797	45, 288	16120	197
		15200	193, 273, 283	15799	174, 283	16125	197, 272
G-14 ...		15220	193	15800	174, 286, 288-289	16130	197, 276
14000	63	15225	197	15805	174, 283, 286, 288-289	16132	197
14010	64, 284, 286	15226	197	15810	174, 284	16133	197
14020	64, 279	15230	196	15820	175	16135	196
14105	63, 282	15240	196	15821	175, 283, 289, 291,	16136	196
14162	65	15250	194, 272-275, 279, 282		293-294	16138	196
14165	65	15271	192	15830	175, 288-289	16160	156
14180	63	15272	192	15840	52	16161	156
14185	63	15273	192	15870	51, 285-286	16166	157
14200	64, 279	15275	194	15875	51, 285-286	16167	157, 272-274
14420	63	15310	199, 280	15880	51, 285	16169	158
14480	56	15312	199, 280	15885	51	16175	155, 157-158, 272, 276
14490	56	15315	188	15900	51, 286	16181	155
14500	56	15350	38	15910	52, 285	16182	155
14530	55, 268	15355	38, 286	15920	31	16185	155
14540	55, 268	15360	167	15921	31	16189	154, 160, 272-273
14550	55, 268, 283, 285	15365	167	15925	31	16190	160
14570	56	15370	167	15926	31	16191	159
		15375	193	15928	32	16193	159
		15376	193	15945	20	16200	65
G-15 ...		15377	193	15946	20	16205	159
15020	185, 287	15390	166	15950	21	16210	158
15050	186	15391	166	15951	21		
15055	186	15392	48	15955	21	G-17 ...	
15065	151, 279	15393	48	15956	22	17000	24
15070	151, 279	15400	166	15960	25, 272-274, 277-278,	17001	24
15075	151, 279	15405	166		280, 282-283	17002	25
15080	151, 279	15470	165	15961	28, 277-278	17003	25
15085	151, 279	15475	165	15962	29	17004	17
15090	151, 279	15477	164	15965	25, 284	17005	27
15095	186, 287	15480	165	15966	25, 279, 289, 291,	17006	27
15096	186	15485	165		293-294	17010	18
15105	188	15540	37	15970	22	17011	18
15110	188	15542	37, 286-287	15975	22	17015	18
15125	188, 282	15545	37	15990	23, 284	17016	18
15130	188, 282	15550	37	15995	23, 283, 288	17017	18
15134	104	15555	37			17019	27
15136	188	15560	37	G-16 ...		17020	15, 272, 282, 285
15137	188	15620	162, 272, 274	16000	24, 288	17021	27
15138	188	15630	162	16010	23	17023	15, 283
15140	191	15635	162	16020	23	17024	28
15141	191, 283	15640	162	16025	23	17025	15
15150	191	15645	162	16030	23	17026	15
15151	191, 273, 283	15710	182	16050	21	17027	19
15160	191	15720	163, 289	16055	21	17030	19
15161	191	15725	163	16060	35, 283, 286, 288	17031	29
15170	192	15730	163	16065	35, 283, 286, 288	17040	36, 285-286
		15731	163				

ITEM NO.	PAGE	ITEM NO.	PAGE	ITEM NO.	PAGE	ITEM NO.	PAGE
17070	38, 287	18171	135, 286	18840	111	279-280, 282-283, 287-289,	
17080	38	18180	135, 272, 279, 282, 284,	18845	111	291, 293-294	
17085	38		287-288, 291, 293-294	18846	112		
17250	69	18181	135, 283-284, 287-288	18847	102	19032	107, 272-273, 283, 289
17260	69	18182	135, 289	18848	102	19034	106
17261	69	18185	135	18850	101, 283, 285	19035	106
17270	69	18190	136, 272, 288-289, 291,	18855	110	19038	107
17271	69		293-294	18856	110	19040	106, 279-280, 286, 288
17280	69	18195	136	18857	111	19045	105
17281	69	18197	136	18860	111	19046	105
17290	69	18210	75	18867	111	19048	107
17291	69	18220	75	18870	111	19050	109, 284, 286
17300	69	18225	75, 287	18880	112	19055	109
17440	88, 143	18232	77	18890	111	19060	109
17441	88, 143	18235	76	18897	112	19080	109, 284
17450	139, 279	18237	77	18900	110, 282	19105	126
17451	139	18238	76, 282	18905	110	19107	127
17452	139	18239	76, 282	18906	110	19112	127, 284, 288
17453	139	18240	249, 287	18908	110	19120	127, 288-289
17460	139	18245	249, 287	18910	110, 272	19125	127, 288-289
17461	139	18300	250, 284	18911	110	19130	43, 272, 273, 282-283,
17462	139	18301	250	18913	112	286, 289, 291, 293-294	
17463	139	18302	250	18914	119, 277-278	19135	43, 288
17500	139, 272-274, 279,	18620	248, 287	18918	122	19137	173, 288
	282-283, 289	18630	248, 287	18919	123	19138	43
17501	139, 289	18645	44	18928	123	19150	116
17505	139, 280	18650	44, 289	18930	122	19230	48, 282
17506	139	18670	134	18935	122, 272, 274	19270	145
17510	140	18680	134, 285-286	18940	105, 284, 287, 291,	19320	145
17511	140	18685	134, 285-286		293-294	19330	145
17515	140	18690	134	18941	125	19345	62
17516	140	18695	134	18944	123	19350	91
17520	141	18700	134	18945	105	19355	91, 284, 286-289
17525	141	18710	134, 285-286	18950	104, 274, 283, 289	19360	91
17530	140	18715	134, 286	18960	104, 272-273, 279, 286,	19365	91
17535	140	18720	101		291, 293-294	19370	91
17540	142	18730	101	18965	104	19375	91, 284-285, 289, 291,
17545	142	18740	101	18966	104		293-294
17560	142	18750	101	18970	105	19380	91
17565	142, 282, 283, 288-289	18780	110	18972	104, 279	19385	91
17570	142, 284, 291, 293-294	18781	110	18975	104	19390	92
17575	142, 272, 284-288	18782	110, 283, 284, 287-289,			19395	92
17610	143		291, 293-294	G-19...		19400	92, 272-274, 279, 282
17615	143	18783	110	19001	103, 279	19405	92
17640	144	18784	110	19005	103, 283, 286, 288-289	19410	92
17645	144	18790	110	19008	103	19420	90
17650	144	18791	110, 272, 279, 282, 285	19010	103, 279, 283, 286, 288,	19425	90
17660	144	18792	110, 282, 284-285, 289		291, 293-294	19430	90
17665	144	18793	110	19015	103	19435	90
		18794	110	19020	103	19450	93
G-18...		18795	126	19022	103	19460	91
18127	145, 236, 277-278	18800	126	19023	103, 273	19465	91
18150	145, 277-278	18805	117	19024	103	19470	89
18160	136	18810	102, 286-288, 291,	19025	103	19475	89, 288-289
18170	135, 286, 291, 293-294		293-294	19026	103	19480	89, 286
		18820	126, 272, 282, 289	19030	106, 272-273,	19485	89, 273, 283-284, 287,
							291, 293-294

ITEM NO.	PAGE	ITEM NO.	PAGE	ITEM NO.	PAGE	ITEM NO.	PAGE
19505	93	19899	259	22540	207	31021	266
19510	93	19960	214	22542	207	31022	267
19520	94	19961	214	22550	199	31023	267
19525	94, 284			22556	207	31024	267
19530	94	G-20...		22615	207	31025	266
19540	86			22619	195, 282	31026	266
19545	86	20040	69	22632	200	31027	267
19550	86	20050	69	22633	200	31028	266
19570	82	20054	69	22636	266	31029	266
19580	82	20055	69	22637	201	31031	267
19585	82	20060	69			31034	268
19590	83	20065	69	G-23...		31105	251
19600	82, 286, 288-289	20070	69			31215	252
19605	82	20080	69	23991	234	31216	252
19607	82	20090	69			31218	252
19615	82	20100	69	G-24...		31219	252
19620	84	20110	69			31230	102
19630	84, 282	20112	69	24100	206-207	31235	102
19640	86	20113	69	24311	205	31299	114
19655	86	20114	69	24314	206	31300	113
19660	87	20115	69	24318	205	31301	114
19675	87	20116	69	24330	206	31303	114
19680	87, 282	20450	69	24332	206	31304	113
19690	81	20455	69	24418	205	31305	114, 272-273
19695	81	20460	69	24430	206	31306	115
19710	81, 272	20465	69	24432	206	31307	113, 274
19715	81, 272	20470	69	24435	206	31308	113
19718	81	20480	69	24440	206	31315	94
19720	81, 279-280	20490	69			31355	194
19725	81, 279-280	20500	69	G-25...		31378	161
19727	82	20510	69	25030	252	31415	136
19740	83	20520	69	25032	252	31420	136
19745	83	20530	69	25034	252	31468	61
19747	83	20540	69			31470	61, 282
19750	89, 272, 279, 282-283, 286, 288-289, 291, 293-294	20550	69	G-28...		31477	62
19751	89	20560	69			31480	62
19760	84, 291, 293-294	20610	69	28220	252	31487	62, 282
19765	84, 272-274, 279, 283, 285	20611	69	28750	213	31490	149
19770	84, 280	20612	69, 282	28752	214	31491	149
19775	85	20613	69	28764	213-214	31496	151, 276
19776	83, 272	20614	69	28766	235	31497	151, 276
19777	83	20615	69	28767	235	31500	151
19780	81	20616	69	28768	235	31501	151
19790	81	20617	69			31502	151
19826	236, 251, 276	20618	69	G-30...		31503	152
19827	236, 251	G-22...				31504	152
19841	259			30146	234	31505	153
19842	259	22100	200, 273, 275	30745	213	31506	153
19846	259	22101	201, 273, 275			31507	153-155, 273, 275
19847	259	22102	200	G-31...		31509	152, 273
19865	259	22105	201			31510	195
19866	259	22106	201	31013	266	31518	120
19867	259	22107	201	31014	268	31519	120
19870	258	22525	207	31016	267	31520	234
		22527	207	31017	267	31545	52, 284
				31018	267	31555	52, 284

ITEM NO.	PAGE	ITEM NO.	PAGE	ITEM NO.	PAGE	ITEM NO.	PAGE
33059	213, 268	33471	212	33870	70	34044	219
33060	213	33472	212	33872	70	34050	220
33065	213	33473	212	33873	70	34053	220
33066	213	33474	212	33874	70	34054	220
33070	209	33475	212	33875	70	34055	220, 273
33071	209	33482	232	33876	70	34056	220
33072	209	33484	211	33877	70	34057	220
33073	209	33485	211	33878	70	34058	220
33075	209, 291	33486	211	33879	70	34060	220
33077	209	33488	233	33880	70	34061	220
33100	260	33489	233	33882	70	34062	220
33102	260	33494	211	33884	70	34063	219
33125	248, 287	33495	211	33885	70	34064	219
33135	191	33650	249, 277	33886	70	34065	219
33140	191	33652	249, 277	33887	70	34066	220
33141	267	33655	249, 277	33890	70	34067	220
33142	267	33657	249, 277	33895	70	34074	220
33160	192	33670	64, 277	33897	70	34075	220
33170	192	33708	150, 182	33899	70	34076	220
33175	192	33725	41	33909	198, 277	34077	220
33180	192	33726	41	33910	199, 277-278	34078	220
33185	192	33727	41, 279	33911	199, 277	34079	220
33190	192	33730	41	33912	168, 277-278	34081	220
33193	188	33732	41	33914	30	34086	220
33194	188, 287	33733	41	33919	26	34091	220
33195	188	33734	41	33920	26, 277	34092	220, 273
33197	192	33735	41	33925	30	34093	220
33198	192, 287	33736	41	33930	168, 277-278	34094	220, 273
33199	195	33737	41	33935	169	34095	220
33200	136, 282, 289, 291, 293-294	33738	41	33940	171, 277	34096	220
33416	280, 193	33739	41	33941	108, 278	34097	220
33420	211	33740	41	33942	171	34098	220
33422	193	33741	41	33943	172, 277-278	34106	220
33425	211, 291	33742	41	33944	173	34111	220
33427	172, 278	33743	43	33950	170, 278	34120	220
33428	118, 277, 278	33744	43	33952	171, 278	34122	220
33429	119, 278	33745	45, 277	33954	171	34124	220
33430	211	33746	45, 277	33958	172	34126	220
33432	128	33747	45, 277	33959	172, 278	34152	220
33433	211	33752	129, 289	33960	119, 278	34177	219
33434	128	33755	149	33961	120, 278	34181	219, 291
33435	128, 291	33757	150	33965	26, 275	34191	219
33436	128	33758	150, 273, 278	33966	170, 275	34192	219
33438	128	33759	150-151, 277-278	33967	170, 275	34196	219
33439	128	33760	46	33968	170, 275	34197	219
33440	121	33762	46	33971	26	34198	219
33441	128	33763	46, 276			34200	228
33450	211	33774	46, 276	G-34 ...		34205	228
33451	211	33776	47, 276	34026	219, 272-273, 283, 286, 289	34210	228, 273
33452	211	33777	47, 276			34215	228
33462	233	33778	47	34031	219	34220	228
33463	232	33780	42	34036	219, 282	34225	228, 272
33468	233	33781	42	34041	219	34230	228
33469	233	33785	45	34042	219	34235	229
33470	212	33786	236, 276-277, 282, 286	34043	219	34240	229
		33831	129			34245	229, 275

ITEM NO.	PAGE	ITEM NO.	PAGE	ITEM NO.	PAGE	ITEM NO.	PAGE
34255	230	34672	241	36298	130	36604	97, 268
34261	228	34678	241	36302	130	36680	133
34265	230	34680	242	36306	130, 291	36690	133
34270	229	34684	242	36312	132, 294	36710	133
34271	229	34686	242	36314	132	36755	133
34275	231	34688	242	36316	130	36765	133
34280	230	34710	243	36318	130	36900	97
34285	232, 293	34806	208, 231	36322	132, 294	36901	97
34289	231	34810	227	36324	132	36902	97
34290	228, 287	34811	228	36326	131	36915	97
34291	231, 291			36328	131	36925	97
34292	232	G-36 ...		36334	130	36930	97
34293	231, 291			36336	131	36955	97
34294	231, 293	36000	250-251, 291, 293-294	36342	132, 293		
34295	232	36010	250-251	36344	132	G-37 ...	
34296	231, 293	36015	250	36352	131		
34297	231, 294	36020	250	36356	130, 291	37000	208
34298	232	36025	250	36358	130	37002	208, 291, 293-294
34299	231, 294	36030	250	36362	132, 293	37005	208
34400	231	36035	251	36364	132	37006	208
34480	233	36045	250	36366	132, 294	37010	208, 210, 267
34492	233	36050	251	36368	132	37011	210
34493	232	36065	251	36502	95	37012	210
34494	232, 293	36202	130	36504	95	37015	210
34495	232	36204	130	36506	95	37020	210
34496	232	36206	130	36512	95	37025	210
34497	232	36208	130	36514	95	37035	210
34498	232	36212	130	36516	95	37046	210
34500	229, 281	36214	130	36518	95	37065	210
34501	229	36216	130	36526	95, 291	37080	208, 211, 267
34523	274	36218	130	36528	95	37100	267
34523-1	227, 272, 274	36222	131	36532	95, 291	37105	267
34602	237	36228	131	36534	95	37390	212
34606	237	36232	131	36536	95	37400	43
34608	237	36236	131	36538	95	37410	43, 291, 293-294
34610	237	36238	131	36540	96, 293	37412	43
34616	237	36242	131	36541	96	37414	43
34618	237	36246	131	36546	95	37418	43
34620	238	36248	131	36552	95	37420	129
34622	238	36252	131	36554	95	37425	150, 291, 293-294
34624	238	36254	131	36556	95	37430	129, 291, 293
34626	238	36256	130, 291	36558	95	37435	176, 291, 293-294
34628	238	36258	130	36562	96	37440	149
34636	239	36262	131	36564	96	37445	182
34638	239	36264	131	36566	96	37500	177
34642	238-239	36266	131	36568	96	37503	177
34644	238-239	36272	131	36572	95	37505	177
34645	238, 240	36274	131	36574	95	37506	177
34646	238-239	36278	130	36576	96, 293	37511	177, 291
34647	238, 240	36282	132, 293	36578	96	37512	177, 293
34656	240	36284	132	36582	96	37513	177, 294
34658	240	36286	132	36586	96, 294	37515	176
34660	240	36288	132	36588	96	37520	176
34664	241	36292	130	36592	96	37525	176
34666	241	36294	130	36600	133	37530	176
34668	241	36296	130	36601	133	37535	176

ITEM NO.	PAGE	ITEM NO.	PAGE	ITEM NO.	PAGE	ITEM NO.	PAGE
37545	176	G-39...		G-42...		46343	222, 293
37549	177					46362	221
37550	176	39501	263	42001	226	46501	226
37551	176, 291	39502	264	42002	226	46502	226
37555	65	39503	264	42009	226	46511	225
37558	176-177	39505	265	42021	225	46521	225
37560	176	39506	264	42022	225	46522	225
37570	176	39511	263	42023	226	46523	226
37580	177	39512	264	42041	222	46541	222, 294
37602	186	39513	264	42042	222	46542	222, 294
37604	186	39514	264	42043	222, 291	46562	221
37700	109	39525	261	42044	222, 291		
37705	109	39526	261, 274-275, 277, 282, 284-285	42061	221, 291	G-61...	
37710	109	39527	261	42301	226	61501	224
G-38...		39528	261	42302	226	61503	224
		39530	263	42311	225, 293	61505	224
38215	86	39535	263	42319	225	61506	224
38236	86	39540	263	42321	225	61508	223
38238	86	39541	262	42322	225	61509	223
38240	85, 116-117, 275	39542	262	42323	226	61509	223
38242	116	39542	262	42341	222	61531	224
38244	116, 275	39543	261	42342	222	61533	224
38246	85, 275	39544	265	42343	222	61535	224
38341	59	39545	262	42344	222, 293	61536	224
38342	60	39546	263	42361	221, 293	61538	223
38343	59	39547	263	42362	221	61539	223
38344	59	39548	262	42501	226	61551	224
38444	60	39549	262	42502	226	61553	224
38448	60, 275	39557	265	42511	225	61555	224
38453	61	39741	256	42521	225	61556	224
38466	61	39745	255	42522	225	61558	223
38473	60	39746	256	42523	226	61559	223
38475	59	39750	255, 272-273, 291, 293-294	42541	222	61571	224
38600	42, 280-281	39753	257	42542	222	61573	224
38601	204, 280-281	39753	257	42544	222, 294	61575	224
38602	204, 280-281	39754	257	42561	221, 294	61576	224
38603	118, 280	39755	257	42562	221	61578	223
38604	169, 280	39762	257			61579	223
38606	118, 169, 280	39764	257	G-46...		61601	223
38607	169, 280-281	39782	256, 272-273, 291, 293-294	46001	226	61603	223
38608	169, 280-281	39783	255-256, 272-273, 291, 293-294	46002	226	61631	223
38610	234	39784	255	46009	226	61633	223
38620	71, 281	39785	255-256	46021	225	61651	223
38621	64, 281	39786	255, 272-273, 291, 293-294	46022	225	61653	223
38622	169, 281	39787	256	46023	226	61671	223
38623	105, 281	39788	256	46041	222, 291	61673	223
38624	117, 281	39789	256	46042	222	G-80...	
38626	227	39791	256	46301	226	80975	230
38628	117			46302	226		
38630	227	G-40...		46311	225	G-150...	
38631	205			46321	225		
38632	205	40006	221, 291, 293-294	46322	225		
38634	118, 280-281	40008	221	46323	226	150001	187
38635	227, 281			46341	222, 293	150002	187
				46342	222	150003	187

ITEM NO.	PAGE	ITEM NO.	PAGE	ITEM NO.	PAGE
150004	187	521250	217	570750	218, 279
150005	187	521300	217	570775	218
150051	187	521350	217	570800	218, 279-280
150052	187	521400	217	570825	218
150053	187	521450	217	570850	218
150054	187	521500	217	570875	218
150055	187	521550	217	570900	218
150101	187, 287	521600	217		
150102	187, 287	521650	217		
150103	187, 287	521700	217		
150104	187	521800	217		
150105	187				
150151	187	G-540 ...			
150152	187	540600	217		
150153	187	540625	217		
150154	187	540650	217		
150155	187	540675	217		
150301	185	540700	217		
150302	185, 287	540725	217		
150303	185	540750	217		
150401	185, 285, 287	540775	217		
150402	185	540800	217		
150403	185	540825	217		
G-500 ...		540850	217		
500001	217	540875	217		
		540900	217		
G-520 ...		540925	217		
520400	217	540950	217		
520500	217	G-560 ...			
520550	217	560600	218		
520600	217	560625	218		
520625	217	560650	218		
520650	217	560675	218		
520675	217	560700	218		
520700	217	560725	218		
520725	217	560750	218		
520750	217	560775	218		
520775	217	560800	218, 279		
520800	217	560825	218		
520825	217	560850	218, 279		
520850	217	560875	218		
520875	217	560900	218		
520900	217	560925	218		
520950	217	560950	218		
521000	217				
G-521 ...		G-570 ...			
521050	217	570600	218		
521100	217	570650	218		
521150	217	570700	218		
521200	217	570725	218		

KEYWORD	PAGE	KEYWORD	PAGE	KEYWORD	PAGE
A					
Absorbent Swabs.....	236, 277 - 278	Backflush Handpiece.....	208, 231, 291, 293 - 294	Capsule Scissors, Osher.....	86
Absorbent Swabs, Single-Use.....	236	Backflush Handpiece, Single-Use.....	231	Capsule Scissors, Yae.....	85, 275
A. C. Maintainer, Single-Use.....	228	Backflush Tip.....	210 - 211	Capsulorhexis Forceps.....	113 - 117, 272 - 275
A. C. Maintainer, Single-Use, Lewicky.....	228	Backflush Tip, Klein.....	210	Capsulorhexis Forceps, Hattenbach.....	117, 274
Adapter.....	214	Ball Capsule Polisher.....	161	Capsulorhexis Forceps, H.-R. Koch.....	114
Air Injection Tube, Single-Use.....	234	Ball Capsule Polisher, Anis.....	161	Capsulorhexis Forceps, Ikeda.....	116, 275
Anterior Chamber Cannula, Single-Use.....	229	Battery Cautery.....	236, 251	Capsulorhexis Forceps, Masket.....	113
Anterior Chamber Cannula, Single-Use, Rycroft.....	229	Bending Laser Probes.....	224	Capsulorhexis Forceps, Utrata.....	113
Anterior Chamber Forceps.....	121	Bending Laser Probes Illuminated.....	224	Capsulotomy Scissors.....	83 - 85, 272 - 274, 279, 280, 282 - 283, 285, 291, 293 - 294
Anterior Chamber Forceps, von Barsewisch.....	121	Bimanual I/A Handpiece Set, Single-Use.....	231	Capsulotomy Scissors, Tuebingen Model.....	84, 282
Anterior Chamber Infusion Cannula.....	193, 280	Bipolar Forceps.....	252	Capsulotomy Scissors, Vannas.....	84 - 85, 272 - 274, 279 - 280, 283, 285, 291, 293 - 294
Anterior Chamber Infusion Cannula, Bonn Model.....	193	Bipolar Handpiece.....	252	Cautery.....	236, 251
Anterior Chamber Infusion Cannula.....	193, 280	Bone Chisel.....	249, 287	CCI Knife.....	220
Anterior Chamber Infusion Cannula, Bopp.....	193, 280	Bone Chisel, West.....	249	Cerclage Forceps.....	127
Anterior Chamber Maintainer, Single-Use.....	228	Bone Gouge.....	249	Cerclage Forceps, Essen Model.....	127
Anterior Synechia Scissors.....	83	Bone Gouge, West.....	249	Chalazion Curette.....	51 - 52, 285 - 286
Anterior Synechia Scissors, Castroviejo.....	83	Bone Nibbling Rongeur.....	75, 287	Chalazion Curette, Axenfeld.....	52, 285
Aspiration Cannula.....	195 - 198, 200, 212, 282, 291	Bone Nibbling Rongeur, Beyer.....	75	Chalazion Curette, Hebra.....	52
Aspiration Cannula, Brauweiler.....	198, 200	Bone Nibbling Rongeur, Citelli.....	75	Chalazion Curette, Meyhoefer.....	51, 285 - 286
Aspiration Cannula Handpiece.....	200	Bone Nibbling Rongeur, Kerrison.....	75, 287	Chalazion Curette, Meyhoeffer.....	285
Aspiration Cannula Handpiece, Brauweiler.....	200	Bonn Injection Set.....	243	Chalazion Forceps.....	134, 285 - 286
Aspiration Cannula, H.-R. Koch.....	198	Bonn Injection Set, Single-Use.....	243	Chalazion Forceps, Ayer.....	134
Aspiration Cannula, Roeder.....	212	Burl Mat, Silicone.....	259	Chalazion Forceps, Cauar.....	134
Aspiration Cannula, Weber.....	212, 291	Burl Mat, Sterisafe.....	264	Chalazion Forceps, Desmarres.....	134, 285 - 286
Aspiration Handpiece.....	200 - 203, 231, 273, 275	C		Chalazion Forceps, Lambert.....	134, 285 - 286
Aspiration Handpiece, Brauweiler.....	202	Caliper.....	43, 272 - 273, 282 - 283, 286, 288 - 289, 291, 293 - 294	Chalazion Forceps, Lordan.....	134, 285 - 286
Aspiration Handpiece, D.D. Koch - T. Kohnen.....	200	Caliper, Castroviejo.....	43, 272 - 273, 282 - 283, 286, 288 - 289, 291, 293 - 294	Chalazion Knife.....	63
Aspiration Handpiece, H.-R. Koch.....	202	Cannula.....	213	Chopper.....	152
Aspiration Handpiece, Koch-Kohnen.....	273, 275	Cannula, Bartz-Schmidt.....	213	Chopper, Multifunctional.....	152
Aspiration Handpiece, R. Koch.....	203	Cannula, Heidelberg Model.....	213	Chopper, Tobias Neuhann.....	152
Aspiration Handpiece, Schmack.....	200 - 201	Cannula Silicone Oil.....	232	Cilia And Foreign Body Forceps.....	101, 283, 285
Aspiration Polishing Cannula.....	197	Cannula, Single-Use.....	232	Cilia And Foreign Body Forceps, Hamburg Model.....	101
Aspiration Polishing Cannula, Teping.....	197	Capsular Ring Injector.....	247	Cilia And Foreign Body Forceps, Shaaf.....	101, 283
Aspiration Speculum.....	277 - 278	Capsular Tension Ring Injector.....	247	Cilia And Suture Forceps.....	101
Aspiration Speculum, Liebermann-Tennant.....	277 - 278	Capsule Forceps.....	274, 116	Cilia And Suture Forceps, Barraquer.....	101
Aspiration Handpiece, Koch-Kohnen.....	275	Capsule Forceps, Arruga.....	116	Cilia And Suture Forceps, Barraquer.....	101
B		Capsule Forceps, H.-R. Koch.....	274	Cilia Forceps.....	101, 285
Backflush Cannula.....	209, 231 - 232, 291, 293 - 294	Capsule Polishing Cannula.....	197 - 198, 230, 272, 276	Cilia Forceps, Barraquer.....	101
Backflush Cannula, Kampik.....	209	Capsule Polishing Cannula, Greite.....	198	Cilia Forceps, Beer.....	101
Backflush Cannula, Laqua.....	209	Capsule Polishing Cannula, Kratz.....	197, 272	Cilia Forceps, Gradle.....	101
Backflush Cannula, Single-Use.....	231 - 232,	Capsule Polishing Cannula, Kyu.....	197	Cilia Forceps, Henry.....	101
		Capsule Polishing Cannula, Papst.....	197	Clamp For Infusion Tube.....	27
		Capsule Polishing Cannula, Single-Use.....	230	Cleaning Adapter.....	97, 266 - 268
		Capsule Polishing Cannula, Single-Use, Kratz.....	230	Clear Cornea Implant Knife (CCI).....	220
		Capsule Polishing Curette.....	161, 276	Clear-Cornea-Incision Diamond Knife, 1.5/2.0 mm.....	60
		Capsule Polishing Curette, Rentsch.....	161, 276	Clear-Cornea-Incision Diamond Knife, 2.2 mm.....	60
		Capsule Scissors.....	85 - 86, 274 - 275	Clear-Cornea-Incision Diamond Knife, 2.85 mm.....	61
		Capsule Scissors, Brauweiler.....	85	Clear-Cornea-Incision Fixation Ring.....	273, 278
		Capsule Scissors, H.-R. Koch.....	85, 274		

KEYWORD	PAGE	KEYWORD	PAGE	KEYWORD	PAGE
Clear Cornea Knife, Single-Use	220	D		Dressing Forceps	110, 272, 279, 282-285, 287-289, 291, 293-294
Clip for Retainer Elements	256	DALK Cannula	229	DSAEK/DMEK Rhexis Forceps	118, 280-281
Coaxial I/A Handpieces	205-207	DALK Probe	188	DSAEK/DMEK Rhexis Forceps, Gerten	118, 280, 281
Colibri Forceps	104, 272-274, 279, 283, 286, 289, 291, 293-294	DALK Probe, Krumeich	188	DSAEK Forceps	118, 280
Combined Needle Holder / Scissors	88, 143	Degree Gauge	46	DSAEK Forceps, Thomas Neuhann	118, 280
Conjunctiva Forceps	102, 286-288, 291, 293-294	Degree Gauge, Mendez	46	DSAEK Implantation Forceps	118, 280
Conjunctiva Forceps, Draeger	102, 286-288, 291, 293-294	Descemet Incision Hook	169, 280, 281	DSAEK Insertion Spatula	280
Conjunctiva Forceps, Foerster	102	Descemet Membrane Forceps	117	DSAEK Insertion Spatula, Thomas Neuhann	280
Conjunctiva Forceps, Freiburg Model	102	Descemet Membrane Forceps, Tobias Neuhann	117	Duct Trephine	69, 282
Conjunctiva Forceps, Kaufmann	102	Descemet Punch	282	Duct Trephine, Schmidt-Mumm	69, 282
Conjunctiva Forceps, Krefeld Model	102	Descemet Punch, Kelly	282		
Container High	291, 293-294, 272-273	Descemet Scraper	169, 280, 281	E	
Corneal Cutting Block, Single-Use	217	Descemet's Membrane Punch	76	Elevatorium	248, 287
Corneal Irrigation Cannula	199, 280	Descemet's Membrane Punch, Kelly	76	Elevatorium, Heidelberg Model	248, 287
Corneal Irrigation Cannula, Krumeich	199, 280	Diaclean CCI Diamond Knife	275	Enclavation Spatula	161
Corneal Marker	41-42, 45, 47, 277, 279-281	Diaclean Clear-Cornea-Incision Diamond Knife, 1.5/2.0 mm	60	Enclavation Spatula, Sekundo	161
Corneal Marker, Hoffer	41	Diaclean Clear-Cornea-Incision Diamond Knife, 2.2 mm	60	Endo Laser Probes	223-224
Corneal Marker, Lindstrom	42	Diaclean Clear-Cornea-Incision Diamond Knife, 2.85 mm	61	Endothelial Insertion Spatula	169
Corneal Marker, Thomas Neuhann	41-42, 279-281	Diaclean Diamond Crescent Knife	61	Endothelial Insertion Spatula, Thomas Neuhann	169
Corneal Pendulum Marker	46, 276	Diaclean Diamond Knife	59	Enucleation Scissors	94, 284
Corneal Pendulum Marker, Scott	46, 276	Diaclean Tri-Facet Diamond Knife	60	Enucleation Spoon	168, 284
Corneal Punch	70, 279	Diaclean Tri-Facet Diamond Knife, Pham	60	Enucleation Spoon, Wells	168, 284
Corneal Punch, Thomas Neuhann	70	Diamond Burr	250, 284	Enzyme Cannula	193
Corneal Scarifier	57, 64, 279, 284, 286	Diamond Crescent Knife, 2.0 mm	61	Ergoline Forceps	133
Corneal Scarifier, Kuhnt	64, 279, 284, 286	Diamond Knife	59, 60, 61, 62, 282	Ergoline Forceps, Tano	133
Corneal Scissors	81-82, 272, 286, 288-289	Diamond Micrometer Knife	62	Ergoline Handpiece	97, 133
Corneal Scissors, Castroviejo	81	Diathermy Connection Cable	252	Ergoline Scissors	97
Corneal Scissors, Katzin	81, 279-280	Diathermy Probe	252	Ergoline Scissors, Heimann	97
Corneal Scissors, Sautter	81, 163, 194, 229, 272-275, 279, 282	Dilator, Lacrimal	185, 197	Ergoline Scissors, Kroll	97
Corneal Scissors, Troutman	81, 272	Dilator, Pupil	247	Ergoline Scissors, Naito	97
Corneal Section Scissors	82	DMEK Cartridge, Single-Use	227, 281	Exenteration Curette	52, 284
Corneal Sideport Knife	219	DMEK-Cartridge, Single-Use, Szurman	227, 281	Exenteration Curette, Bunge	52, 284
Cornea Suture Marker	279, 43	DMEK Graft Retainer	71, 281	Explantation Forceps	125, 274
Cornea Suture Marker, Suffo / Homburg Model	279, 43	DMEK Graft Retainer, Szurman	71, 281	Explantation Hook	158
Corneoscleral Punch	77	DMEK Irrigation Handpiece	205	Explantation Hook, Tandogan	158
Corneoscleral Punch, Gass	77	DMEK Irrigation Handpiece, Szurman	205	Expressor Cannula	195
Crescent Blade Tip	220	DMEK Keratoplasty Forceps	105, 281	Expressor Cannula, Klöckner	195
Crescent Knife	61, 220	DMEK Keratoplasty Forceps, Remky	105, 281	Eye Douche	193, 273, 283
CRVO Knife	66	DMEK Preparation Forceps	117, 281	Eye Douche, Cranz	193, 273, 283
CRVO Knife, Dithmar	66	DMEK Preparation Forceps, Szurman	117, 281	Eye Scissors	91-93, 272-274, 279, 282, 284-289, 291, 293-294
Curved Laser Probes	223	DMEK Preparation Scraper	64, 281	Eye Scissors, Bonn Model	92, 272-274, 279, 282
Cyclodialysis Spatula	165, 194	DMEK Preparation Scraper, Szurman	64, 281	Eye Scissors, Graefe	93
Cyclodialysis Spatula Cannula	194	DMEK Preparation Spatula	169, 281	Eyeshield	251
Cyclodialysis Spatula Cannula, Busse	194	DMEK Preparation Spatula, Szurman	169, 281	Eye Shield	285
Cyclodialysis Spatula, Castroviejo	165	DMEK RAPID	227	Eye Speculum	15-32, 272-275, 277-280, 282-285, 288-289, 291, 293-294
Cyclodialysis Spatula, Elschmig	165	DMEK RAPID Szurman	227	Eye Speculum, Bangerter	23
Cystotome Cannula, Single-Use	228	DMEK Transplant Forceps	117	Eye Speculum, Barraquer	15-17, 19, 272-274, 282-283, 285
		DMEK Transplant Forceps, Yörük	117		
		Double Needle Stabilizer	151		
		Double Needle Stabilizer, Yamane	151		

KEYWORD	PAGE	KEYWORD	PAGE	KEYWORD	PAGE
Sautter.....	229	Iris Forceps, Elze.....	112	Irrigation Handpiece.....	200-203, 205, 231, 273, 275
Hydrodissection Cannula, Single-Use, Tuebingen Model.....	229	Iris Forceps, Hamburg Model.....	112	Irrigation Handpiece, Brauweiler.....	203
Hydrodissection Cannula, Spirig.....	194	Iris Forceps, Heidelberg Model.....	111	Irrigation Handpiece, D.D. Koch - Kohnen.....	201
Hydrodissection Cannula, Tuebingen Model.....	194	Iris Forceps, Swiss Model.....	111-112	Irrigation Handpiece, D.D. Koch - T. Kohnen.....	201
I		Iris Forceps, Thomas Neuhann.....	112	Irrigation Handpiece, Koch-Kohnen.....	273, 275
I/A Cannula.....	272	Iris Hook.....	155-159, 272-273	Irrigation Handpiece, Schmack.....	200
I/A Cannula, Simcoe.....	272, 274	Iris Hook and Lens Manipulator.....	158-159	Irrigation Trabeculotomy Cannula.....	195
I/A Cannula, Single-Use.....	230	Iris Hook and Lens Manipulator, Dardenne.....	158	Irrigation Trabeculotomy Cannula, Burk.....	195
I/A Cannula, Single-Use, Simcoe.....	230	Iris Hook and Lens Manipulator, Frankfurt Model.....	159	Irrigation Vectis Cannula.....	195, 230, 272
I/A Handpiece.....	205-207, 231	Iris Hook and Nucleus Dividing Hook.....	155	Irrigation Vectis Cannula, Single-Use.....	230
I/A Handpiece, Hunold.....	207	Iris Hook and Nucleus Dividing Hook, Kohnen.....	155	IVOM Set.....	243
I/A Handpiece, Papst.....	207	Iris Hook and Nucleus Dividing Hook, Thomas Neuhann.....	154, 273	J	
Illuminated Bending Laser Probes.....	224	Iris Hook, Bonn Model.....	159	Jewelers Type Forceps.....	109
ILM-Scraper.....	176, 291	Iris Hook, Dardenne.....	272	K	
ILM-Scraper, Bartz-Schmidt.....	176, 291	Iris Hook, Kohnen.....	155	Karate Phaco Chopper.....	153
Implantation Forceps, 118, 121-123, 272-274		Iris Hook, Lund.....	159	Karate Phaco Chopper, Agarwal.....	153
Implantation Forceps, Doden.....	122, 272, 274	Iris Retractor.....	272, 274	Keratome.....	63
Implantation Forceps, Fechner.....	121	Iris Retractor, Single-Use.....	227, 274	Keratome, Hamburg Model.....	63
Implantation Forceps, Kohnen.....	122	Iris Scissors.....	86-87	Keratometer.....	46, 279
Implantation Forceps, Sekundo.....	123	Iris Scissors, Barraquer.....	87	Keratometer, Maloney.....	46, 279
Implantation Forceps, Shepard.....	122	Iris Scissors, Noyes.....	86	Keratoplasty Forceps.....	104-105, 279
Implantation Forceps, Tobias Neuhann.....	123	Iris Scissors, Wecker.....	86-87	Keratoplasty Forceps, Remky.....	105
Incision Measuring Caliper.....	43	Iris Spatula.....	166-167	Keratoplasty Forceps, Thomas Neuhann.....	104, 279
Incision Measuring Caliper, Osher.....	43	Iris Spatula, Bangerter.....	167	Keratoplasty Knife.....	64, 279
Indicator.....	257, 261	Iris Spatula, Frankfurt Model.....	166	Keratoplasty Knife, Paufigue.....	64, 279
Infusion Cannula.....	193, 211, 232-233, 280, 291	Iris Spatula, Wecker.....	166	Keratoplasty Scissors.....	81-82, 279-280
Infusion Cannula, Single-Use.....	232-233	Irrigating Chopper, Dick.....	204	Keratoplasty Scissors, Katzin.....	279-280
Infusion Sleeve.....	205-207	Irrigation / Aspiration Cannula.....	196-197	Keratoplasty Scissors, Mackensen.....	82
Infusion Tube 20G, Single-Use.....	226	Irrigation / Aspiration Cannula Coaxial.....	197	Keratoplasty Scissors, Thomas Neuhann.....	164, 279
Injection Cannula.....	193, 195, 211-212, 230, 233, 291	Irrigation / Aspiration Cannula, Simcoe.....	196	Keratoplasty Spatula.....	69, 70
Injection Cannula, Duisburg Model.....	211, 291	Irrigation Cannula.....	196, 198-200, 230, 277, 280, 282, 285	Keratoplasty Spatula, Best.....	69
Injection Cannula, Hamburg Model.....	212	Irrigation Cannula, Binkhorst.....	196	Keratoplasty Spatula, Franceschetti.....	69
Injection Cannula, Single-Use.....	230, 232-233	Irrigation Cannula, Bonn Model.....	196, 285	Keratoplasty Spatula, Hamburg Model.....	69
Injection Cannula, Single-Use, Kirchof.....	233	Irrigation Cannula, Brauweiler.....	198, 200	L	
Injector.....	247, 274	Irrigation Cannula Handpiece.....	199-200	Label.....	256-257
Intraocular Diathermy Probe.....	252	Irrigation Cannula Handpiece, Brauweiler.....	200	Lacrimal Cannula.....	191-192, 228, 273, 283, 287
Intraocular Magnet.....	251, 291	Irrigation Cannula Handpiece, Keerl.....	200	Lacrimal Cannula, Anel.....	191, 287
Intraocular Magnet, Kuhn.....	251, 291	Irrigation Cannula, Mueller.....	196	Lacrimal Cannula, Bonn Model.....	192
Intravitreal Injection Set.....	243	Irrigation Cannula, Rentsch.....	196	Lacrimal Cannula, Single-Use.....	228
IVOM.....	243	Irrigation Cannula, Single-Use.....	230, 282	Lacrimal Intubation Set.....	228
Intubation Set, Single-Use.....	228	Irrigation Chopper.....	204	Lacrimal Intubation Set, Single-Use.....	228
IOL Forceps.....	125, 274, 276	Irrigation Chopper, R. Koch.....	204	Lacrimal Intubation Tubing.....	227
IOL Forceps, Snyder-Osher.....	125, 274, 276	Irrigation Cystotome Cannula.....	193	Lacrimal Intubation Tubing, Single-Use.....	227
IOL Haptic Expander.....	123	Irrigation Descemet Hook.....	281, 204	Lacrimal Probe.....	185, 187-188, 192, 285, 287
IOL Haptic Expander, Dick.....	123	Irrigation Descemet Hook, Althaus / Carlsburg.....	204, 280-281	Lacrimal Probe, Bowman.....	187, 287
IOL Scissors.....	87-88, 274, 276	Irrigation Descemet Hook, Neuhann.....	280-281		
IOL Scissors, Snyder-Osher.....	88, 274, 276	Irrigation Descemet Scraper.....	204, 280-281		
IOL Scissors, Steinmetz.....	87, 274	Irrigation Descemet Scraper, Neuhann.....	280-281		
Iris Forceps.....	110-112, 272, 282, 286, 289	Irrigation Descemet Scraper, Thomas Neuhann.....	204		
Iris Forceps, Bonn Model.....	110-111, 272, 282				

KEYWORD	PAGE	KEYWORD	PAGE	KEYWORD	PAGE
Lacrimal Probe Cannula	192, 287	Lens Loop Manipulator	158	Membrane Peeler	177, 291, 293-294
Lacrimal Probe Cannula, Bangerter	192	Lens Loop Manipulator, Lester	158	Membrane Peeler, Morris-Kroll	177
Lacrimal Probe Cannula, Juenemann	192, 287	Lens Loop Manipulator, Zirm	158	Membrane Punch	76
Lacrimal Probe, Giessen Model	185, 287	Lens Loop, Snellen	162	Membrane Spatula, Lucke	176
Lacrimal Probe, Juenemann	188, 192, 287	Lens Loop, Spirig	162	Micro Colibri Forceps	104, 272-273, 279, 286, 291, 293-294
Lacrimal Probe, Wilder	185, 285, 287	Lens Loop, Weber	162	Microfinger	155
Lacrimal Sac Retractor	37-38, 286-287	Lens, Macheimer	250	Microfinger, Lieberman	155
Lacrimal Sac Retractor, American Model	38	Lens Manipulation Hook	157, 272-274	Micro Forceps	116, 278
Lacrimal Sac Retractor, Axenfeld	37, 286-287	Lens Manipulation Hook, Sinsky	157, 272-274, 157	Micro Forceps, Tobias Neuhann	116
Lacrimal Sac Retractor, Goldstein	38	272-274, 157	Micro Hook	177
Lacrimal Sac Retractor, Mueller	38	Lens Manipulator	156-159	Micro Knife	66
Lacrimal Sac Retractor, Rollet	37	Lens Manipulator and Hook	157	Micro Knife, Hansen	66
Lamellar Blade	220	Lens Manipulator and Hook, Rentsch	157	Micro Round Knife	63, 282
LASEK Epi Peeler	64, 277	Lens Manipulator, Bremen Model	157	Micro Stitch Scissors	82
LASEK Epi Peeler, Lohmann	64, 277	Lens Manipulator, Jacobi	156	MICROSTOP Container high	291, 293-294
LASEK Funnel	249, 277	Lens Manipulator, Mainz Model	156	MICROSTOP Clip for Retainer Elements	256
LASEK Funnel, Lohmann	249, 277	Lens, Peyman	250	MICROSTOP Container high	255
LASEK Spatula	169	Lens Spatula	158	MICROSTOP Container High	272-273
LASEK Trephine	277	Lens Spatula, Hirschmann	158	MICROSTOP Container low	255
Laser Probes Bending	224	Lens, Tolentino	250	MICROSTOP ID Label	256
Laser Probes Curved	223	Lenticule Forceps	119-120, 278	MICROSTOP Label	256
Laser Probes Straight	223	Lenticule Forceps, Rupal Shah	119	MICROSTOP Logistic Frame	257
LASIK Cannula	198, 277	Lenticule Micro Forceps	278	MICROSTOP Retainer Element	256, 272-273, 291, 293-294
LASIK Cannula, Bauer	277	Lenticule Micro Forceps, Rupal Shah	278	MICROSTOP Seal	257
LASIK Cannula, W. Bauer	198	Lid Plate	36, 285-286	MICROSTOP Tag	257
LASIK Corneal Flap Forceps	119	Lid Plate, Jaeger	36, 285-286	MICROSTOP Tray Lid mini	256
LASIK Corneal Flap Forceps, Buratto	119	Lid Retractor	35-36, 283-286, 288	MICROSTOP Tray mini	255, 272-273, 291, 293-294
LASIK Corneal Marker	277	Lid Retractor, Desmarres	35-36, 283-286, 288	Micro Trabeculectomy Punch	76
LASIK Corneal Marker	45, 277	283-286, 288	Micro Trabeculectomy Punch, Grehn	76
LASIK Corneal Marker, Chayet	45, 277	Lid Retractor, Giessen Model	36	MICS Capsule Forceps	115-116
LASIK Corneal Marker, Lu	45, 277	Lieberman	274	MICS Capsule Forceps, H.-R. Koch	115-116
LASIK Corneal Marker, Mendez	45, 277	Limbal Relaxing Incision Diamond Knife	61	MICS Capsulorhexis Forceps	115-116, 275
LASIK Corneal Protector	168, 277-278	Localizer and Scleral Depressor	182	MICS Capsulorhexis Forceps, Auffarth	275
LASIK Corneal Protector, Zirm	168, 277-278	Localizer and Scleral Depressor, Meyer-Schwickerath	182	MICS Capsulorhexis Forceps, Ikeda	116
LASIK Dissector Cannula	199, 277-278	LRI Knife	220	MICS Capsulorhexis Forceps, Inamura	115
LASIK Dissector Cannula, Zirm	199, 277-278	M		MICS Capsulorhexis Forceps, Kampik	115
LASIK Eye Speculum	26, 30, 277	MACH2 High Speed Vitreous Cutter, Single-Use	226	MICS Double Cross Action Capsulorhexis Forceps	115
LASIK Eye Speculum, Knorz	26, 277	Magnet, Intraokular	251, 291	MICS Double Cross Action Capsulorhexis Forceps, Auffarth	273
LASIK Eye Speculum, Maus	30	Manipulator	155-159	MICS Double Cross Action Capsulorhexis Forceps, Auffarth	115
LASIK Eye Speculum, Zirm	30	Manipulator, Frankfurt Model	157	Mini Filter, Single-Use	234
LASIK Flap Forceps	277-278	Manipulator, Mainz Model	156	Mosquito Forceps	135, 272, 279, 282-284, 286-289, 291, 293-294
LASIK Flap Forceps, Buratto	277-278	Marker	277, 282, 288	Mosquito Forceps, Halstead	135, 272, 279, 282-284, 287-289, 291, 293-294
LASIK Irrigation Cannula	199, 277	Marker, Fink	288	Mosquito Forceps, Hartmann	135, 286, 291, 293-294
LASIK Irrigation Cannula, Zirm	199, 277	Marker, Fronimopoulos	282	Multifunctional Chopper	152
LASIK Spatula	168, 277-278	Marking Hook	157	Multifunctional Chopper, Jacobovitz	152
LASIK Spatula, Neuhann	277	Marking Hook, Sinsky	157	Muscle Forceps	127, 284, 288-289
LASIK Spatula, Rau	169	Marking Instrument	291, 293-294	Muscle Forceps, Bangerter	127, 284, 288
LASIK Spatula, Thomas Neuhann	168, 278	Marking Pen	236, 276-277, 282, 286		
Lens... ..	88, 250-251, 272, 274, 291, 293-294	Marking Pen, Single-Use	236		
Lens Extraction Hook	156	Measuring Spatula	44		
Lens Extraction Hook, Hennig / Friedrich ...	156	Measuring Spatula, Engels	44		
Lens Handle Ring	251	Melag Metal Grid Insert	265		
Lens, Kilp	250, 291, 293, 294				
Lens, Landers	250				
Lens Loop	158, 162, 272				
Lens Loop, Artl	162, 272, 274				

KEYWORD	PAGE	KEYWORD	PAGE	KEYWORD	PAGE
Muscle Forceps, Sattler.....	127, 288-289	Nucleus Dividing Hook, Thomas Neuhann.....	151, 275	Phaco Slit Knife.....	273
Muscle Tucker.....	173	Nucleus Dividing Hook, Völcker.....	152	Phaco Slit Knife, Single-Use.....	220, 273
MVR Stilett.....	219	Nucleus Dividing Hook, Zirm.....	152	Phaco Spatula.....	160
MVR Stiletto.....	219	Nucleus Manipulator and Anterior Capsule Polisher.....	155	Phaco Spatula, Amon.....	160
N		Nucleus Manipulator and Anterior Capsule Polisher, Drysdale.....	155	Phaco Spatula, D. D. Koch.....	160
NanOEdge.....	217, 219	Nucleus Rotator.....	153-154, 156, 170	Phaco Spoon.....	160
NanOEdge Clear Cornea Knife.....	220	Nucleus Rotator and Chopper.....	153	Phaco Spoon, Engels.....	160
NanOEdge Corneal Cutting Block.....	217	Nucleus Rotator and Dividing Hook.....	154	Pigtail Probe.....	186, 287
NanOEdge Corneal Sideport Knife.....	219	Nucleus Rotator and Dividing Hook, Thomas Neuhann.....	154	Position Hooks.....	156-157
NanOEdge Crescent Blade Tip.....	220	Nucleus Rotator, Thomas Neuhann.....	153-154, 156	Prechopper.....	120, 273
NanOEdge Crescent Knife.....	220	Nucleus Rotator, Thomas Neuhann and Chopper, Tobias Neuhann.....	153	Prechopper, Akahoshi.....	120, 273
NanOEdge Knives, Single-Use.....	219	Nucleus Spreading Forceps.....	120	Precision Depth Knife.....	220
NanOEdge Lamellar Blade.....	220	Nucleus Spreading Forceps, Akahoshi.....	120	Precision Depth Knife (LRI).....	220
NanOEdge MVR Stilett.....	219	Nucleus Sustainer.....	155	Prefolder.....	124
NanOEdge MVR Stiletto.....	219, 291	Nucleus Sustainer, Akahoshi.....	155	Prefolder, H.-R. Koch.....	274
NanOEdge Paracentesis Knife.....	272-273, 282-283, 286, 289	O		Pressure Connection Tube.....	213
NanOEdge Paracentesis Knives.....	219	Oblong Silicone Sponge Implant.....	241	Pressure Tube.....	213
NanOEdge Phaco Slit Knife.....	220, 273	Oculopressor.....	48	Pressure Tube, Single-Use.....	213, 233
NanOEdge Precision Depth Knife.....	220	Oculopressor, Homburg Model.....	48	Probe for Stromal Channel.....	186
NanOEdge Scleral Blade.....	220	Oil Injection System, Single-Use.....	235	Ptosis Forceps.....	134, 286
NanOEdge Spoon Knife.....	220	Operating Scissors.....	94	Ptosis Forceps, Berke.....	134, 286
NanOEdge Stab Blade Tip.....	219	Orbital Spatula.....	163-164, 289, 291, 293-294	Punch.....	70, 279, 282
NanOEdge Trapezoid Clear Cornea Implant Knife (CCI).....	220	Orbital Spatula, Behrens-Baumann.....	163	Pupil Dilator Injector.....	247
NanOEdge Trepphine Punches.....	217	Orbital Spatula, Hamburg Model.....	163, 289	Push-Pull.....	276
NanOEdge Trepphines.....	217	Orbital Spatula, Sautter.....	163	R	
NanOEdge Vacuum Corneal Punch.....	279	Oval Silicone Sleeve.....	240	Raspatory.....	248, 287
NanOEdge Vacuum Trepphine.....	218, 279-280	Oval Silicone Sponge Implant.....	241	Raspatory, Heidelberg Model.....	248, 287
NanOEdge Vacuum Trepphine Punches.....	218	P		Razor Blade Holder.....	145
NanOEdge Vacuum Trepphine radial.....	218	Paper Filter.....	257	Razor Blade Holder, Barraquer.....	145
Nasal Forceps.....	127	Paracentesis Knife 15°.....	272-273, 283, 286, 289	Razor Blade Holder, Castroviejo.....	145
Nasal Forceps, Troeltsch.....	127	Paracentesis Knife 30°.....	282	Razor Blade Holder, Troutman.....	145
Nasal Speculum.....	287, 248	Paracentesis Knives.....	219	Replacement Ring.....	251
Needle Holder.....	88, 139-144, 272-274, 279-280, 282-289, 291, 293-294	Peelers.....	177	Retainer Element.....	256, 272-273, 291, 293-294
Needle Holder, Arruga.....	144	Pendulum Instrument.....	47	Retainer For Pendulum Instrument.....	47
Needle Holder, Barraquer.....	139-141, 272-274, 279-280, 282-283, 289	Pendulum Instrument Retainer.....	47	Retainer Strip.....	262, 263
Needle Holder, Barraquer-Troutman.....	140	PEP 2.2 mm I/A Handpiece.....	205	Retina Diamond Knife.....	62
Needle Holder, Boynton.....	144	PEP 2.2 mm Infusion Sleeve.....	205	Retractor.....	38, 272, 274, 283-288
Needle Holder, Castroviejo.....	142, 272, 282-289, 291, 293-294	PEP 2.4 mm I/A Handpiece.....	206	Retractor, Guthrie.....	38, 286
Needle Holder, Heidelberg Model.....	144	PEP 2.4 mm Infusion Sleeve.....	206	Retrolubar Cannula, Single-Use.....	228
Needle Holder, Jacobi.....	139, 279	Peribulbar Cannula, Single-Use.....	228	Retrolubar Cannula, Single-Use, Atkinson.....	228
Needle Holder, Kalt.....	143	PFCL Cannula.....	212, 232, 293	Retrolubar Injection Cannula.....	193
Needle Stabilizer.....	151	PFCL Cannula, Chang.....	212	Retrograde Probe.....	186
Nucleus Dividing Hook.....	151-155, 273, 275	PFCL Cannula, Single-Use.....	232, 293	Retrograde Probe, Kellnar.....	186
Nucleus Dividing Hook, Haefliger.....	153	Phaco Chopper.....	153	Rinsing Adapter For Wire Baskets.....	265
Nucleus Dividing Hook, Kohnen.....	155			Rongeur.....	75, 248, 287
Nucleus Dividing Hook, Miyoshi.....	151			Rongeur, Friedmann.....	287, 248
Nucleus Dividing Hook, Nagahara.....	153-154, 273, 275			Round Silicone Sponge Implant.....	240
				Ruler.....	44, 289
				Ruler, Giessen Model.....	44

KEYWORD	PAGE	KEYWORD	PAGE	KEYWORD	PAGE
S		Silicone Plate.....	259	Single-Use Hydrodissection Cannula, Tuebingen Model.....	229
Sato Knife.....	65	Silicone Replacement Ring.....	250 - 251	Single-Use I/A Cannula.....	230
Sato Knife, Dardenne.....	65	Silicone Sleeve.....	239	Single-Use I/A Cannula, Simcoe.....	230
Sato Knife, Foerster.....	65	Silicone Sponge Implant.....	242	Single-Use Infusion Cannula.....	232 - 233
Sato Knife, Hansen.....	65	Silicone Strip.....	238 - 239	Single-Use Infusion Tube 20G UNO Colorline.....	226
Scalpel Handle.....	236, 284 - 285	Silicone Strip Blue.....	259	Single-Use Injection Cannula.....	230, 232 - 233
Scissors.....	272 - 276, 279 - 280, 282 - 284, 286, 287 - 289, 291 - 294	Silicone Tire.....	237	Single-Use Injection Cannula, Kirchhof.....	233
Scissors, Barraquer.....	282	Silicone Tire, Asymmetrical.....	237	Single-Use Iris Retractor.....	227, 272 - 274
Scissors, Heimann.....	97	Silicone Tire, Concave.....	237	Single-Use Irrigation Cannula.....	230, 282
Scissors, Kroll.....	97	Silicone Tire, Convex.....	237	Single-Use Irrigation Vectis Cannula.....	230
Scissors, Naito.....	97	Silicone Tray.....	258	Single-Use Knives.....	219
Scissors, Single-Use.....	221	Silicone Tubings For G-39544.....	265	Single-Use Lacrimal Cannula.....	228, 287
Scissors, Westcott.....	89, 272, 279, 282 - 283, 286, 288 - 289, 291, 293 - 294	Single-Use Absorbent Swabs.....	236, 277 - 278	Single-Use Lacrimal Intubation Set.....	228
Scleral Blade.....	220	Single-Use A. C. Cannula.....	229	Single-Use Lacrimal Intubation Tubing.....	227
Scleral Depressor.....	150, 181 - 182, 285, 289	Single-Use A. C. Cannula, Rycroft.....	229	Single-Use Laser Probes Bending.....	224
Scleral Depressor, Kreissig.....	181	Single-Use A. C. Maintainer.....	228	Single-Use Laser Probes Curved.....	223
Scleral Depressor, Laqua.....	181, 289	Single-Use A. C. Maintainer, Lewicky.....	228	Single-Use Laser Probes Straight.....	223
Scleral Depressor, Lucke.....	181	Single-Use Anterior Chamber Cannula.....	229	Single-Use Low Temperature Battery Cautery.....	236
Scleral Depressor, Schocket.....	182	Single-Use Anterior Chamber Maintainer.....	228	Single-Use Marking Pen.....	236, 276 - 277, 282, 286
Scleral Fixation Ring.....	151	Single-Use Backflush Cannula.....	231 - 232, 291, 293 - 294	Single-Use Mini Filter.....	234
Scleral Fixation Ring, Flieringa.....	151	Single-Use Backflush Handpiece.....	231	Single-Use MVR Stilett.....	219
Scleral Flap Marker.....	44, 282	Single-Use Bimanual I/A Handpiece Set.....	231	Single-Use Oil Injection System.....	235
Scleral Flap Marker, Tobias Neuhann.....	44, 282	Single-Use Bonn Injection Set.....	243	Single-Use Paracentesis Knife 15°.....	272 - 273, 283, 286, 289
Scleral Knife.....	63	Single-Use Cannula.....	232	Single-Use Paracentesis Knife 30°.....	282
Scleral Knife, Bonn Model.....	63	Single-Use Capsule Polishing Cannula.....	230	Single-Use Paracentesis Knives.....	219
Scleral Plug.....	128, 291	Single-Use Capsule Polishing Cannula, Kratz.....	230	Single-Use Peribulbar Cannula.....	228
Scleral Plug Forceps.....	128	Single-Use Clear Cornea Knife.....	220	Single-Use PFCL Cannula.....	232, 293
Scleral Ruler.....	44, 288	Single-Use Corneal Cutting Block.....	217	Single-Use Phaco Slit Knife.....	220, 273
Scleral Ruler, Vogt.....	44, 288	Single-Use Crescent Knife.....	220	Single-Use Pressure Tube.....	213, 233
Seal.....	257, 259	Single-Use Cystotome Cannula.....	228, 272	Single-Use Retrobulbar Cannula.....	228, 273
Seal / Label.....	263	Single-Use DALK Cannula.....	229	Single-Use Retrobulbar Cannula, Atkinson.....	228, 273
Security Seal.....	263	Single-Use DMEK-Cartridge.....	227, 281	Single-Use Silicone Chamber.....	231
Semi-Circular Silicone Sponge Implant.....	242	Single-Use DMEK Cartridge, Szurman.....	227, 281	Single-Use Silicone Sleeve.....	240
Semifine.....	136, 272, 288 - 289, 291, 293 - 294	Single-Use DMEK Transportation Cartridge.....	227	Single-Use Silicone Sponge Implant.....	241
Serrefine.....	136, 272, 288 - 289, 291, 293 - 294	Single-Use Fiber Optics.....	225	Single-Use Spoon Knife.....	220
Serrefine, Dieffenbach.....	136, 272, 288 - 289, 291, 293 - 294	Single-Use Fiber Optic S UNO Colorline.....	225	Single-Use Syringe.....	234
Sideport Knife.....	219	Single-Use Fiber Optic WS UNO Colorline.....	226	Single-Use Syringe BD Emerald TM.....	234
Silicone Ball.....	48	Single-Use Fiber Optic W UNO Colorline.....	225	Single-Use Tano Forceps.....	294
Silicone Block.....	71	Single-Use Forceps.....	293	Single-Use Tano Forceps UNO Colorline.....	222
Silicone Block for DMEK.....	71	Single-Use Forceps, Tano.....	294	Single-Use Three-Way Stop Cock.....	234
Silicone Block for DMEK, Örk Linz Model.....	71	Single-Use Handle.....	221	Single-Use Trephine Punches.....	217
Silicone Block with Center Point.....	71	Single-Use High Speed Vitreous Cutter MACH 2 UNO Colorline.....	226	Single-Use Trephines.....	217
Silicone Bulb.....	214, 285	Single-Use High Speed Vitreous Cutter UNO Colorline.....	226	Single-Use Trocar Plugs UNO Colorline.....	225
Silicone Burl Mat.....	259, 264	Single-Use High Temperature Battery Cautery.....	236, 251	Single-Use Trocar System.....	293
Silicone Chamber.....	208, 231	Single-Use Hydrodissection Cannula.....	229, 275	Single-Use Trocar System One-Step UNO Colorline.....	225
Silicone Chamber, Single-Use.....	231	Single-Use Hydrodissection Cannula, Frankfurt Model.....	229	Single-Use Trocar System One-Step UNO Colorline, Hattenbach / Nikolic.....	225
Silicone Circling Band.....	238	Single-Use Hydrodissection Cannula, Sautter.....	229, 275	Single-Use Tubing With Luer Connector.....	227
Silicone Closure.....	260			Single-Use Unfolding Cannula.....	229
Silicone Lens Bi-Sector.....	88, 274				
Silicone Lens Bi-Sector, H.-R. Koch.....	88, 274				
Silicone Nap Strip blue.....	259				
Silicone Perforated Tray.....	258				

KEYWORD	PAGE	KEYWORD	PAGE	KEYWORD	PAGE
Single-Use Unfolding Cannula, Saad	229	Sterilization Container	255	Suture Hook	173, 287
Single-Use Vacuum Corneal Punch	279	Sterilization Container, Sterisafe	261	Suture Hook, Muenster Model	173, 287
Single-Use Vacuum Trephine	279-280	Sterilization Rack	258	Suture Marker	42, 279
Single-Use Vacuum Trephine Punches	218	Sterilization Tray	255	Suture Marker, Duncker	42, 279
Single-Use Vacuum Trephine Radial	218	Sterilization Tray Lid	256	Suture Marker, Thomas Neuhann	42
Single-Use VFI Cannula For Oil I/A	232	Sterilization Tray, Sterisafe	261, 262	Suture Removing Forceps	104, 285
Single-Use Vitreous Cutters		Sterisafe Duro A4	261	Suture Removing Forceps, Barraquer	104
UNO Colorline	226	Sterisafe Duro A4 Plus	261	Suturing Forceps	103-105, 273, 279, 283-284, 286-289, 291, 293-294
Single-Use Vitreous Forceps	294	Sterisafe Duro A4 Plus Complete Set	261, 274-275, 277, 282, 284-285	Suturing Forceps, Castroviejo	103, 273, 279, 283, 286, 288-289, 291, 293-294
Single-Use Vitreous Forceps Crocodile Design	291, 293	Sterisafe Duro A6	261	Suturing Forceps, Munich Model	103
Single-Use Vitreous Forceps Crocodile Design 20G	291, 293	Sterisafe Duro Metal Tray A4-15	262	Suturing Forceps, Zurich Model	104
Single-Use Vitreous Forceps Crocodile Design UNO Colorline	222	Sterisafe Duro Metal Tray A4-30	262	Swabs, Absorbent	236
Single-Use Vitreous Forceps Endgripping	291, 293-294	Sterisafe Duro Metal Tray A6-15	262	Synechia Spatula	164
Single-Use Vitreous Forceps Endgripping 23G	293	Sterisafe Duro Metal Tray A6-30	262	Synechia Spatula, Binkhorst	164
Single-Use Vitreous Forceps Endgripping 25G	294	Sterisafe Duro Wire Basket A4-30	261	Synechia Spatula, Castroviejo	164
Single-Use Vitreous Forceps Endgripping UNO Colorline	222	Sterisafe Duro Wire Basket A6-30	262	Syringe BD Emerald	234
Single-Use Vitreous Forceps Wave Design UNO Colorline	222	Sterisafe Filter	263	Syringe Clip	214
Single-Use Vitreous Forceps Wave Design UNO Colorline, Hattenbach	222	Sterisafe Filter Tag Expiration Date	263	Syringe Holder	214
Single-Use Vitreous Scissors	291, 293-294	Sterisafe Metal Grid Insert	264-265	Syringe, Single-Use	234
Single-Use Vitreous Scissors UNO Colorline	221	Sterisafe Silicone Burl Mat	264		
Spare Silicone Tube	212	Sterisafe Silicone Grid Insert	264	T	
Spare Tubing Set	26	Sterisafe Silicone Retainer Strip 75	262	Tag	257
Spatula	44, 154, 159-160, 163-164, 167-168, 194, 272-273, 275, 277, 280, 282, 289, 291, 293-294	Sterisafe Silicone Retainer Strip 145	263	Tano Forcep, Single-Use	222
Spatula and Dividing Hook, Thomas Neuhann	154	Sterisafe Silicone Retainer Strip 230	263	Temporal Approach Eye Speculum	17
Spatula and Nucleus Dividing Hook	154	Stiletto	64, 219	Temporal Approach Eye Speculum, H.-R. Koch	17
Spatula and Retractor	168	Stitch Scissors	82, 92	Tenotomy Scissors	89-90, 273, 283-284, 286-289, 291, 293-294
Spatula and Retractor, Giessen Model	168	Stitch Scissors, Spencer	92	Tenotomy Scissors, Bonn Model	90
Spatula, Bangerter	163, 289	Stop Cock	234	Tenotomy Scissors, Stevens	89, 273, 283-284, 286-289, 291, 293-294
Spatula, Essen Model	167	Stopper	213	Textile Filter	257
Spatula, Knife	176	Strabismus Hook	174-175, 283-286, 288, 289, 291, 293-294	Three-Way Stop Cock, Single-Use	234
Spatula, Rentsch	160, 280	Strabismus Hook, Bonn Model	175, 283, 289, 291, 293-294	Tissue Forceps	110
Spatula, Spirig	159	Strabismus Hook, Graefe	174, 283-284, 286, 288-289	TOMARK Adjustable Corneal Marker	47, 276
Spatula, Steinmetz	159	Strabismus Hook, Hamburg Model	174	TOMARK Pendulum Instrument	47, 276
Spatula, Thomas Neuhann and Nucleus Dividing Hook, Nagahara	154	Strabismus Hook, Jameson	175, 283, 285, 291, 293-294	Tonometer	48, 282
Speculum	15-32, 272-273, 277-278, 284, 293-294	Strabismus Hook, Malbran	175, 288-289	Tonometer, Schioetz	48, 282
Spoon Knife	220	Strabismus Marker	45	Toric Marker	47
Spreading Forceps	120, 129, 289	Strabismus Marker, Fink	45	Towel Forceps	136, 282, 289, 291, 293-294
Spreading Forceps, Hoerauf	129	Strabismus Muscle Tucker	173, 288	Towel Forceps, Backhaus	136
Spreading Forceps, Watzke	129, 289	Strabismus Muscle Tucker, Cueppers	173, 288	Towel Forceps, Schaedel	136, 282, 289, 291, 293, 294
Stab Blade Tip	219	Strabismus Scissors	90-91, 285	Trabecular Aspiration Cannula	282
Sterilization Case	260	Strabismus Scissors, Bonn Model	90	Trabecular Aspiration Cannula, Ph. Jacobi	282
		Straight Laser Probes	223	Trabecular Probe	188, 282
		Sub-Tenon Injection Cannula	195	Trabecular Probe, Harms	188, 282
		Sub-Tenon Injection Cannula, Nagata	195	Trabecular Probe, Mackensen	188
		Suffo	279, 43	Trabeculectomy Marker	44
		Superior Rectus Forceps	126-127, 272, 282, 289	Trabeculectomy Marker, Fronimopoulos	44
		Superior Rectus Forceps, Castroviejo	127	Trabeculectomy Punch	76, 282
		Superior Rectus Forceps, Elschmig	126	Trabeculectomy Punch, Luntz-Dodick	76, 282
		Superior Rectus Forceps, Leydhecker	126	Trabeculum Scissors	83
		Superior Rectus Forceps, Remky	126, 272, 282, 289		

KEYWORD	PAGE	KEYWORD	PAGE	KEYWORD	PAGE
Trapezoid Clear Cornea		UNO Colorline Single-Use Instruments	221 - 222, 225 - 226	Vitreous Cutter	226
Implant Knife (CCI)	220	UNO Colorline Laser Probes	223 - 224	Vitreous Cutters, Single-Use	226
Tray mini	272 - 273, 291, 293 - 294	UNO Colorline Trocar Plugs	225	Vitreous Forceps	294
Tray, Silicone	258	UNO Colorline Trocar System	293	Vitreous Forceps Crocodile Design	222, 291, 293
Trephine	69 - 70, 249, 277, 279 - 280, 282	UNO Colorline Trocar System, Hattenbach / Nikolic	293	Vitreous Forceps Endgripping	291, 293 - 294
Trephine, Best	69	UNO Colorline Trocar System One-Step	225	Vitreous Forceps Endgripping, Single-Use	222
Trephines	217 - 218	UNO Colorline Vitreous Cutters	226	Vitreous Forceps Wave Design, Single-Use	222
Triangle Scleral Depressor	182	UNO Colorline Vitreous Forceps	222, 294	Vitreous Scissors	291, 293 - 294
Triangle Scleral Depressor, Hattenbach	182	UNO Colorline Vitreous Forceps Crocodile Design	222, 291, 293	Vitreous Scissors, Single-Use	221
Tri-Facet Diamond Knife	60	UNO Colorline Vitreous Forceps Endgripping	222		
Tri-Facet Diamond Knife, Pham	60	UNO Colorline Vitreous Forceps, Hattenbach	294	W	
Tri-Facet Diamond Step Knife	61, 282	UNO Colorline Vitreous Forceps Wave Design, Hattenbach	222	Wire Loop	88
Trocar Closure Forceps	129	UNO Colorline Vitreous Scissors	221, 291, 293 - 294		
Trocar Closure Forceps, Bartz-Schmidt	129	U-Shaped Probe	188		
Trocar Forceps	129, 291, 293	U-Shaped Probe, Thomas Neuhann	188		
Trocar Plugs, Single-Use	225	Utrata	114		
Trocar System	293				
Trocar System One-Step, Single-Use	225	V			
Trocar Systems, Single-Use	225	Vacuum Corneal Punch	279		
Tubings for Rinsing Adapters	265	Vacuum Corneal Punch, Single-Use	279		
Tubing With Luer Connector	227	Vacuum Trephine	279 - 280		
Tying Forceps	105 - 108, 272 - 274, 279 - 280, 282 - 283, 286 - 289, 291, 293 - 294	Vacuum Trephine Punches	218		
Tying Forceps, Bangerter	107	Vacuum Trephine Radial	218		
Tying Forceps, Bonn Model	106	Vacuum Trephine, Single-Use	279 - 280		
Tying Forceps, Dardenne	107	VFI Cannula For Oil I/A	232		
Tying Forceps, Paufique	105	Viscoelastic Cannula	195		
Tying Forceps, Tuebingen Model	106, 272 - 273, 279 - 280, 282 - 283, 286 - 289, 291, 293 - 294	Visual Axis Marker	45		
		Visual Axis Marker, Grene	45		
U		Vitreotomy Lenses	250		
Unfolding Cannula	229	Vitreoretinal Forceps	129 - 132, 291, 293 - 294		
Universal Prechopper	121	Vitreoretinal Forceps 20 gauge	130 - 131		
Universal Prechopper, Akahoshi	121	Vitreoretinal Forceps 23 gauge	132		
Universal Prefolder, H.-R. Koch	124	Vitreoretinal Forceps 25 gauge	132		
Universal Suturing Forceps	105, 284, 287, 291, 293 - 294	Vitreoretinal Forceps, A. Mueller	130		
Universal Suturing Forceps, Paufique	105, 284, 287, 291, 293 - 294	Vitreoretinal Forceps, Naito	130		
UNO Colorline	221	Vitreoretinal Forceps, Reimann	129		
UNO Colorline Curved Laser Probes	223	Vitreoretinal Forceps, Tano	130, 132 - 133, 291, 291, 293 - 294		
UNO Colorline Fiber Optic S	225	Vitreoretinal Scissors	95 - 96, 291, 293 - 294		
UNO Colorline Fiber Optic W	225	Vitreoretinal Scissors 20 gauge	95		
UNO Colorline Fiber Optic WS	226	Vitreoretinal Scissors 23 gauge	96		
UNO Colorline Forceps	291, 293 - 294	Vitreoretinal Scissors 25 gauge	96		
UNO Colorline Forceps, Tano	291	Vitreoretinal Scissors, Heimann	95 - 96, 291, 293 - 294		
UNO Colorline Handle	291, 293	Vitreoretinal Scissors, Kroll	95		
UNO Colorline Handle 20G, 23G, 25G	221	Vitreoretinal Scissors, Naito	95		
UNO Colorline High Speed		Vitreoretinal Scissors, Roider	95		
Vitreous Cutter	226				
UNO Colorline High Speed					
Vitreous Cutter MACH 2	226				
UNO Colorline Infusion Tube 20G	226				

NAME	PAGE	NAME	PAGE	NAME	PAGE
A					
Agarwal.....	153	Cauer.....	134	Greite.....	198
Akahoshi.....	120-121, 155, 273	Chang.....	212	Grene.....	45
Althaus / Cartsburg.....	204, 281	Chansue.....	170-171, 278	Guell.....	171
American Model.....	38	Chayet.....	45, 277	Guthrie.....	38, 286
Amon.....	160	Citelli.....	75	H	
Anel.....	191, 287	Cook.....	23, 24, 283-284	Haefliger.....	153
Anis.....	161	Cranz.....	193, 273, 283	Halstead.....	135, 272, 279, 282-284, 287-289, 291, 293-294
Arlt.....	162, 272, 274	Cueppers.....	173, 288	Hamburg Model.....	63, 69, 162-163, 173-174, 289,
Arruga.....	116, 144	D		Hansen.....	65-66
Auffarth.....	115, 273, 275	Dardenne.....	65, 107, 158, 272	Harms.....	188, 282
Axenfeld.....	37, 52, 285-287	Desmarres.....	35-36, 134, 283-286, 288	Hartmann.....	135, 286, 291, 293-294
Ayer.....	134	Dick.....	26, 122-123, 170, 204, 275	Hattenbach.....	86, 108, 117, 143, 149, 176, 182, 222, 225, 266, 274, 276, 291, 293-294
B					
Backhaus.....	136	Dieffenbach.....	136, 272, 288-289, 291, 293-294	Hattenbach / Nikolic.....	225, 293
Bangerter.....	23, 107, 127, 167, 192, 284, 288-289	Dithmar.....	66	Hebra.....	52
Barraquer.....	15-19, 87, 101, 104, 109, 139, 140-141, 145, 272-274, 279-280, 2 82-285, 289	Doden.....	122, 272, 274	Heidelberg Model.....	109, 111, 144, 213, 248, 287
Barraquer Frankfurt Model.....	16	Draeger.....	102, 286-288, 291, 293-294	Heimann.....	95-97, 128, 291, 293-294,
Barraquer-Oosterhuis.....	18	Drysdale.....	155	Hennig / Friedrich.....	156
Barraquer-Troutman.....	140	Duisburg Model.....	211, 291	Henry.....	101
Barsewisch, von.....	121	Duncker.....	42, 279	Hess-Engelking.....	112
Bartz-Schmidt.....	176, 213, 291	E		Hirschmann.....	158
Bauer.....	198, 277	Elschnig.....	126, 165	Hoerauf.....	129
Beer.....	101	Elze.....	112	Hoffer.....	41
Behrens-Baumann.....	163	Engels.....	44, 160	Hoffmann.....	170, 275
Berke.....	134, 286	Essen Model.....	127, 167	Homburg Model.....	43, 48
Best.....	69	F		Hunold.....	207
Beyer.....	75	Fechner.....	121	I	
Binkhorst.....	164, 196	Fine.....	82, 149-150, 277-278	Ikeda.....	116, 275
Blum.....	171, 277	Fine-Thornton.....	149-150, 277-278	Inamura.....	115
Bonn Model.....	63, 90, 92, 106, 110-111, 159, 175, 192-193, 196, 272-274, 279, 282-283, 285, 289, 291, 293-294	Fink.....	45, 288	J	
Bopp.....	193, 280	Flieringa.....	151, 279	Jacobi.....	156, 195, 279, 282
Bowman.....	187, 287	Foerster.....	65, 102, 150, 182	Jacobovitz.....	152
Boynton.....	144	Franceschetti.....	69	Jaeger.....	36, 285-286
Braunstein.....	43	Frankfurt Model.....	16, 157, 159, 166, 194, 229, 272, 282-283	Jameson.....	175, 283, 285, 291, 293-294
Brauweiler.....	85, 198, 200, 202-203	Freiburg Model.....	102	Japan Model.....	85, 117, 275
Bremen Model.....	157	Friedmann.....	248, 287	Juenemann.....	188, 192, 267, 287
Breyer.....	170-172, 275, 278	Fronimopoulos.....	44, 282	K	
Bunge.....	52, 284	G		Kalt.....	143
Buratto.....	119, 277-278	Gaskin.....	108, 274	Kammann.....	29
Burk.....	195	Gass.....	77	Kampik.....	115, 209
Busse.....	194	Gerten.....	46, 118, 276, 281	Katzin.....	81, 279-280
C					
Castroviejo.....	23, 43, 81, 83, 126-127, 142, 145, 164-165, 272-273, 279, 282-289, 291, 293-294	Giessen Model.....	36, 44, 168, 185, 287	Kaufmann.....	102
		Goldstein.....	38	Keerl.....	200
		Gradle.....	101	Kellnar.....	186
		Graefe.....	93, 109, 174, 283-284, 286, 288-289		
		Grehn.....	76, 282		

NAME	PAGE	NAME	PAGE	NAME	PAGE
Kelly.....	76, 282	Mellinger.....	20	S	
Kelman-McPherson.....	108, 278	Mellinger-Beard.....	20	Saad.....	229
Kerrison.....	75, 287	Mendez.....	45-46, 277	Sattler.....	127, 288-289
Kershner.....	25, 279, 284, 289, 291, 293-294	Meyer-Schwickerath.....	182	Sauer.....	19
Kilp.....	250, 291, 293-294	Meyhoefer.....	51, 285-286	Sautter.....	81, 163, 194, 229, 272-275, 279, 281-282
Kirchhof.....	131, 233	Meyhoeffer.....	285	Schaedel.....	136, 282, 289, 291, 293-294
Klein.....	210	Miyoshi.....	151	Schioetz.....	48, 282
Klöckner.....	195	Mohr.....	77	Schmack.....	200-201
Knorz.....	26, 119, 277-278	Morcher.....	247, 274	Schmidt-Mumm.....	69, 282
Koch, D.D.....	160, 201	Morris-Kroll.....	177	Schocket.....	182, 285
Koch, D.D.-Kohnen.....	200-201, 273, 275	Mueller.....	38, 130, 196, 287	Schott.....	31-32
Koch, H.-R.....	17, 85, 88, 114-116, 124, 198, 202, 274	Muenster Model.....	173, 287	Scott.....	46, 276
Koch, R.....	203-204	Munich Model.....	103	Sekundo.....	123, 161
Koga / Noda.....	28	Murdock.....	24-25	Shaaf.....	101, 283, 285
Kohnen.....	122, 155, 173, 200-201	N		Shepard.....	122
Kratz.....	17-19, 197, 230, 272	Nagahara.....	153-155, 273, 275	Simcoe.....	196, 230, 272, 274
Kratz-Barraquer.....	17, 19	Nagata.....	195	Sinskey.....	157, 172-173, 272-274
Krefeld Model.....	102	Naito.....	95, 97, 130	Snellen.....	162
Kreissig.....	181	Neuhann.....	70, 116-117, 123, 154, 277, 280-281	Snyder.....	88
Kroll.....	95, 97, 177	Neuhann, Tobias.....	123	Snyder-Osher.....	88, 125, 274, 276
Krumeich.....	42, 188, 199, 280	Noda.....	27-29	Solomon.....	26
Kuhn.....	251, 291	Noyes.....	86	Spaleck.....	124
Kuhnt.....	64, 279, 284, 286	O		Spencer.....	92
Kyu.....	197	Ohno.....	17	Spirig.....	159, 162, 194
L		Örk Linz Model.....	71	Steinmetz.....	87, 159, 274
Lambert.....	134, 285-286	Osher.....	43, 86, 88, 125, 274, 276	Stevens.....	89, 273, 283-284, 286-289, 291, 293-294
Landers.....	250	P		Strobel.....	125
Laqua.....	181, 209, 289	Papst.....	197, 207, 266	Suffo / Homburg Model.....	43
Lester.....	158	Paufique.....	64, 105, 279, 284, 287, 291, 293-294	Swiss Model.....	111-112
Lewicky.....	228	Paulmann.....	27	Szurman.....	64, 71, 105, 117, 169, 205, 227, 281
Leydhecker.....	126	Peyman.....	250	T	
Liebermann.....	25, 28, 155, 272-273, 277-278, 282	Pfaeffl.....	118, 172, 277, 278	Takeda.....	19
Liebermann-Tennant.....	25, 28, 272-274, 277-278, 280, 282-283	Pfaeffl-Breyer.....	172	Tandogan.....	158
Lindstrom.....	42	Pfennigwerth.....	128	Tano.....	130, 132-133, 291, 293-294
Lohmann.....	64, 249, 277	Plange.....	55-56	Teping.....	197
Lordan.....	134, 285-286	Pretori.....	21	Thomas Neuhann.....	19, 41-42, 70, 104, 112, 118, 151, 153-154, 156, 168-169, 188, 204, 273, 275, 278-281
Lu.....	45, 277	R		Thornton.....	149, 150, 277-278
Lucke.....	176	Rau.....	169	T. Neuhann.....	123
Lund.....	159	Reimann.....	129	Tobias Neuhann.....	44, 116-117, 152, 282
Luntz-Dodick.....	76, 282	Remky.....	105, 125, 126, 272, 281-282, 289	Tolentino.....	250
M		Rentsch.....	157, 160-161, 196, 276, 280	Troeltsch.....	127
Machemer.....	250	Rohrschneider.....	144	Troutman.....	81, 140, 145, 272
Mackensen.....	82, 188	Roider.....	95, 212	Tuebingen Model.....	84, 106, 194, 229, 272-273, 280, 282-289, 291, 293-294
Mainz Model.....	156	Rollet.....	37	U	
Malbran.....	175, 288-289	Rupal Shah.....	119, 278	Utrata.....	113
Maloney.....	46, 279	Rycroft.....	229		
Masket.....	113				
Maus.....	30				
Mead.....	248, 287				

NAME PAGE

V

Vannas.....	84-85, 272-274, 279-280, 283,285, 291, 293-294
Vogt.....	44, 288
Völcker.....	152
von Barsewisch.....	121

W

Watzke.....	129, 289
Weber.....	162, 212, 291
Wecker.....	86-87, 166
Weiss.....	21-22
Wells.....	168, 284
West.....	249
Westcott.....	89, 272, 279, 282-283, 286,288-289, 291, 293-294
Wilder.....	185, 285, 287
Wright.....	249

Y

Yae.....	85, 275
Yamane.....	151
Yörük.....	117

Z

Zenoni.....	176
Zirm.....	30, 152, 158, 168, 199, 277-278
Zuerich Model.....	104

CUSTOMER SERVICE INSTRUMENTS



COMPETENT CONSULTING

- Tray screening and advice
- Optimization of instrumentarium
- Need-based offers



VALUE-PRESERVING REPAIR

- Restore functionality and performance to fulfill the intended use
- Repair with original spare parts according to the manufacturer's specifications
- Individual and damage-specific repair, also considering economic efficiency
- Final inspection before delivery
- High repair rate of 80 %
- Possible replacement if repair is not feasible or economical



QUALIFIED SERVICE

- Specialists for different types of instruments
- Competence by our trained surgical mechanics
- Professional expertise through decades of experience



WE TAKE CUSTOMER SERVICE SERIOUSLY

By acquiring one of our high-quality products, you also receive access to our services. Based on our competent advice, which is non-binding for you, you can choose between our wide range of services, if required.

The maxim of precision and perfection of Geuder AG products also applies to our after sales service. Professionalism and care are essential factors for our international success. With more than 40 highly qualified and experienced microsurgery mechanics and electronics engineers, we offer comprehensive maintenance and repair services for your instruments, device systems and accessories.

Use our repair service now.

Please use the form on our website* or give us a call:



CUSTOMER SERVICE INSTRUMENTS
+49 6221 306-798

Send repairs (preferably with a proof of decontamination**) to:

Geuder AG (Reference: Repair) | Hertzstr. 4 | 69126 Heidelberg | Germany

or ask your sales representative to pick it up during his next visit.

* Repair order form on our website:

www.geuder.de/en/service-support/repairs

** If you do not have your own proof of decontamination, you can download our form (see link above)





MAXIMUM FLEXIBILITY

FOR RETINAL LASER PHOTOCOAGULATION



endoTRON[®] 532



More information
about Single-Use Laser Probes
on pages 223 / 224

Please find more information and brochure downloads on our website:
www.geuder.de/en/products/devices-and-accessories/megaTRON-s4-hps-microsurgical-system/



MAXIMUM PERFORMANCE

THE MEGATRON S4 HPS HIGH PERFORMANCE SYSTEM
WITH MAXIMUM FLEXIBILITY FOR THE ANTERIOR
AND POSTERIOR SEGMENT



UP TO
12.000
CPM*



megaTRON® S4 ^{HPS}



More information about
Single-Use MACH2 High Speed
Vitreous Cutters on page 226

* in combination with UNO Colorline MACH2 High Speed Vitreous Cutters



HIGH PERFORMANCE IN ENDOILLUMINATION

XENON LIGHT SOURCE
WITH PHOTOTOXGUARD



xenoTRON[®] III
with
phototoxGUARD



More information about
Single-Use Fibre Optics
on pages 225 / 226

Please find more information and
brochure downloads on our website:
www.geuder.de/en/products/devices-and-accessories/solea-rgb-led-light-source



SEEING THE FULL SPECTRUM

RGB LED LIGHT SOURCE
FOR OPHTHALMIC SURGERY



SOLEA®





More information about
Single-Use Fibre Optics
on pages 225 / 226

Innovative Biomaterials for Ophthalmic Surgery

Dyes



Posterior Segment

- Brilliant Peel[®]
 G-81010
- Brilliant Peel[®] Dual Dye
 G-81015





Anterior Segment

- Vioron[®]
 G-81002

Intraoperative Tamponades



F-Decalin

-  5 ml: G-80315
-  7 ml: G-80317
-  5 ml: G-80305
-  7 ml: G-80307

F-Octane

-  5 ml: G-80115
-  7 ml: G-80117
-  5 ml: G-80105
-  7 ml: G-80107

Long-Term Tamponades Gases



- EasyGas[®] SF₆
 G-80950

- EasyGas[®] C₂F₆
 G-80960

- EasyGas[®] C₃F₈
 G-80970

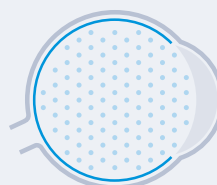



Please find more information
on our website at
www.fluoron.de

Ultrapure fluids and gases made in Germany

Long-Term Tamponades Silicone Oils



Siluron® Xtra
 G-80750
 Siluron® 2000
 G-80740

Siluron® 1000
 G-80720
 G-80710
 Siluron® 5000
 G-80820
 G-80810

Long-Term Tamponades Heavy Silicone Oils



Densiron® Xtra
 G-80925
 Densiron® 68
 G-80920
 G-80910

Cleansing Fluid / WashOut Solution



F4H5® WashOut
 G-80615
 F4H5® WashOut
 Procedure Pack
 + G-80616

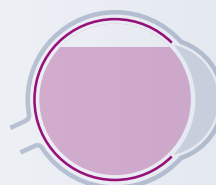
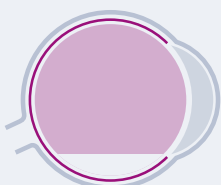



Geuder[®]
Precision made in Germany

CE 2797

GEUDER AG
Hertzstrasse 4
69126 Heidelberg
Germany

Phone: +49 6221 3066
Fax: +49 6221 303122
info@geuder.de
www.geuder.com